

Sixty-Six Theses: Next Steps and the Way Forward in the Modified Cosmological Model

Jonathan W. Tooker

July 26, 2023

Abstract

The purpose is to review and lay out a plan for future inquiry pertaining to the modified cosmological model (MCM) and its overarching research program. The material is modularized as a catalog of open questions that seem likely to support productive research work. The main focus is quantum theory, but the material spans a breadth of physics and mathematics. Cosmology is heavily weighted, and some Millennium Prize problems are included. A comprehensive introduction contains a survey of falsifiable MCM predictions and associated experimental results. Listed problems include original ideas deserving further study as well as investigations of others' work when it may be germane. A longstanding and important conceptual hurdle in the approach to MCM quantum gravity is resolved with a framework for quantum cosmology time arrow eigenstates. A new elliptic curve application is presented. With several exceptions, the presentation is high-level and qualitative. Formal analyses are mostly relegated to the future work which is the topic of this book. Sufficient technical context is given that third parties might independently undertake the suggested work units.

Contents

Introduction	1
Review and Main Results	1
The MCM Unit Cell	14
The MCM Particle Scheme	26
Part I: The Modified Cosmological Model	30
The \hat{M}^3 Operator and its Equation	30
Introduction	30
The Ontological Basis	36
Tensor States	51
MCM Spin Spaces	57
Maximum Action	59
Fractional Distance and Levels of Aleph	62
Operators, States, and the Schrödinger Equation	77
Wavefunction Collapse	93
The Fine Structure Constant	107
Quantum Gravity	116
Elliptic Curves and the Total Evolution Operator	134
Part II: Problems in Physics	142
Period Doubling	142
Field Line Breaking	145
Curvature in the Neighborhood of Infinity	147
Continuous Particle Creation and Annihilation	150
Wavepackets Extending to Infinity	152
Dark Energy	152
Vacuum Energy	158
Spin Angular Momentum	159
Spinor Structure from Spacetime	159
Antisymmetry for Fermionic Wavefunctions	161
Time Arrow Spinors	161
Supersymmetry	167
Representations of Quantum Algebras	169
Mechanical Precession	170

The Advanced Electromagnetic Potential	171
Kaluza–Klein Theory	175
Classical Electrogravity	176
ϕ^4 Quantum Field Theory	176
Stimulated Emission from the Vacuum	179
The Dual Tangent Space	181
Reverse Time in Quantum Field Theory	181
Absorber Theory	183
Renormalization and Regularization	184
AdS/CFT Correspondence and Holographic Duality	185
Numerical Analysis	185
The Location of the Observer	186
Boundary Terms at Infinity	188
<u>Part III: Problems in Mathematics</u>	190
The Prime Number Theorem	190
The Riemann ζ Function in Quantum Theory	191
The Hodge Theater and Anabelomorphy	193
Regularity Structures	198
Quantum Set Algebra	200
The Navier–Stokes Equation	209
The Yang–Mills Mass Gap	210
The Banach–Tarski Paradox and Information Density	211
The Topology of the Real Line	212
The Twin Primes Conjecture	213
The Limits of Sine and Cosine at Infinity	214
The Cauchy Residue Theorem	216
Intermediate Numerical Scale	217
<u>Part IV: More Problems in Physics</u>	217
Randall–Sundrum Models	218

Brans–Dicke Theory	224
The Arnowitt–Deser–Misner Theorem	224
The Borde–Guth–Vilenkin Theorem	226
The Ehrenfest Paradox	227
The Ford Paradox	228
Intrinsic Periodicity	229
Non-Local Hidden Variables	230
Λ CDM Cosmology	230
The Landau–Yang Theorem	230
A Clopen Universe	231
The Galactic Rotation Anomaly	231
Neutrino Helicity	232
Local Gauge Symmetry	233
The Amplituhedron	234
Time Crystals	237
Cellular Automata	240
Feynman’s Division of the Time Interval	243
Path Integrals	244
The Golden Ratio in Black Holes	244
Rydberg States	245
Two Time Models	246
Time and Imaginary Time	246
String Theory	247
Fast Radio Bursts	248
<u>APPENDICES</u>	250
A: The Origin of \hat{M}^3	250
B: Focused Review of Quantum Mechanics	263
The Translation Operator	263
The Momentum Operator	273
The Time Evolution Operator	279
C: Historical Context	286

0 Introduction

This book contains a long list of thesis problems in physics and mathematics. A previous review [1] was written to broaden the horizons of the modified cosmological model (MCM), and the present purpose is to pinpoint within those horizons ideas that should be brought forward to completion.

0.1 Review and Main Results

During the MCM's main development phase, this writer had already exited the academic environment which is most conducive to initial surveys of topics concluding in original contributions at the level of a PhD thesis. The fixation of this research program on the bare fundamentals has come at the expense of such "PhD-level" work, and this condition provides fodder for detractors. Thus, remediation is in order.

While the fractional distance program in real analysis [2] must exceed the requirements for a PhD in mathematics, this writer has rarely taken research in physics to a conclusive calculation, and never at the level of a PhD thesis. In the way that mathematicians are sometimes said to be concerned with the existence of solutions more so than with finding them, it follows that this writer's thesis equivalent [2] is in real mathematical analysis. The presumed existence of solutions has sufficed throughout the MCM's development, contrary to what is most common in physics. First and foremost, however, this writer is a physicist. Physics ultimately requires real solutions for experimental applications. It was hoped for many years that others would jump at the chance to write the papers in which such solutions are given, but history has taken a different tack. In light of events, the present work describes many open and untreated questions that have arisen in the development of the MCM.

An early computation in the MCM found a characteristic length scale for new physics at 10^{-4}m [3]. As it is the aim of this research program to tie up physics' loose ends with a new model of cosmology (and ontology with quantum applications), the characteristic scale was obtained when the structure of the MCM was applied in an intuitive way to the foremost unsolved problem in classical mechanics: the precession of spinning discs. If any theory will be a *theory of everything*, it will lay to rest the open questions in classical mechanics. Thus, an MCM mechanism for anomalous mechanical precession was supposed. The calculation yielding 10^{-4}m was very simple,

but, on the other hand, precession is not a manifestly complicated problem. The result was remarkable because 10^{-4}m is neither the nano-scale of quantum mechanics nor the macro-scale of classical mechanics. Instead, an intermediate meso-scale was obtained in the regime where catch-all *losses due to friction* are usually called on to scoop up everything not classically deterministic or quantum mechanical. Furthermore, Arkani-Hamed and others have already written about the open question of new physics at the sub-millimeter scale [4,5]. Is it only a coincidence that 10^{-4}m lies in the narrow strip where new physics is not forbidden? This question deserves further study because the result cannot be ruled out immediately.

The mechanism surrounding the scale calculation in [3] was well defined but possibly not as well motivated as is expected in professional publications. One reason for this is that this writer is not a professional. As an unpaid contributor, he is not constrained by the professional community standards which sometimes make it difficult to put highly speculative ideas to paper. Still, the 10^{-4}m result is remarkable. If 10^{-30} , 10^{-10} , 10^0 , or 10^{10}m was determined as the scale for the mechanism proposed in [3], then we could know without any further thinking that the mechanism is unphysical. To the contrary, the computation shows that experiment allows the idea, in part, at least. If the work of physicists is to rule out theories, which are only ideas or *formalized* ideas, then this calculation shows that the MCM passes at least one hurdle of its falsifiable predictions not being ruled out. The hurdle was not high, but first hurdles rarely are.

The best prediction to come from the MCM is that there should not exist any spin-0 fundamental particles such as the Higgs boson. This prediction is directly falsifiable in a way that exceeds the possibility for new effects on a certain scale. The prediction is perfectly well motivated [6]. It is as clean and concise as any prediction in the history of physics, and it arose in the following line of inquiry. After a brief review of Kaluza–Klein theory (KKT), the MCM unit cell (Section 0.2) was constructed in [7]. The purpose of the construction was to build on previous work in the MCM so as to address some of the failures of KKT detailed by Overduin and Wesson [8]. Namely, the so-called *cylinder condition* requires that 4D Kaluza–Klein physics in spacetime must not depend on the fifth coordinate. This condition is generated or satisfied in the MCM when the realm of physics is taken as a 4D Poincaré section (slice) of a 5D space for some constant value of the fifth coordinate. This is the main condition set by the MCM unit cell. Another problem is that KKT only allows solutions in which the electromagnetic (EM) field strength tensor $F_{\mu\nu}$ vanishes. While one 5D Kaluza–Klein (KK) metric tensor contains an EM potential 4-vector and a dual 4-vector, the MCM

uses two such metrics containing twice as many degrees of freedom. This doubling of the degrees of freedom should be sufficient for $F_{\mu\nu} \neq 0$ solutions.

While much work remains to formalize the MCM at the level of Kaluza's and Klein's original papers [9, 10], the MCM unit cell was assembled in [7] to address KKT's main problems. Soon after, it was demonstrated that the unit cell offers a good answer to the fundamental question of quantum field theory (QFT) [6]. That question asks why we have the particles we have and not some other particles. The *standard model* of particle physics is pretty good for determining what our particles do, but it does nothing to address the fundamental question about why we have the standard model particles to begin with. In the MCM, the spectrum of lattice vibrations in the unit cell is identical to the known spectrum of elementary particles (Section 0.3). Thus, the spectrum of fundamental particles results from a fundamental geometric structure underlying reality. Even such nuance as the eight varieties of gluons arises in the MCM lattice from simple classical mechanics. Each particle is given as a different kind of spring or mass in a 5D lattice of masses connected by springs. The ultimate goal of QFT is to generate the true spectrum of fundamental particles from theory itself without having to force agreement with experiment by the imposition of an empirical model, i.e.: the standard model, and the MCM fits the bill. The main disagreement with the standard model is in the scheme for fundamental bosons. The standard model supposes that there exists a spin-0 fundamental particle: the famous scalar boson following from the work of famous people such as Englert, Brout, Higgs, Guralnik, Hagen, and Kibble [11–17]. In its current incarnation, the MCM scheme does not permit the existence of any spin-0 fundamental particles. So, the MCM answer to the fundamental question of QFT is plainly falsifiable.

Posed in early 2013, the prediction that all fundamental bosons should have spin-1 followed on the heels of the discovery of a new particle at CERN in 2012 [18, 19]: the Higgslike particle. If that particle is found to have spin-0, then the MCM is wrong, and it needs to be revised or scrapped. If that particle is the Higgs boson, or if it is any possible variety of Higgs boson, it will have spin-0. The objective existence of a spin-0 fundamental particle would send an important MCM result back to the drawing board. More than causing the rescission of a prediction, the entire structure of the model would be cast into doubt. As it stands, the MCM is supposed to generate the fundamental particles as lattice vibrations in an almost (but not quite) trivial model of lattice cosmology. The truthfulness of this prediction requires that the Higgslike particle has spin-1.

Though many detractors of the MCM cite an alleged mountainous body of evi-

dence proving that the Higgslike particle does not, and cannot, have spin-1, Ralston has shown that spin-1 was not ruled out by the initial observations at CERN [20]. Arkani-Hamed has also stated in a talk [21] that spin-1 is not ruled out for the Higgs-like particle. Ralston, in his analysis of the decay channels reported by CERN, cites “model-independent Lorentz invariance” as allowing spin-1, but, in the ten years since the particle was discovered, this writer has not seen a treatment of these *model independent* amplitudes. Instead, the ATLAS collaboration rules out “some specific models” of spin-1 [22], “several alternative spin scenarios” [23], and “alternative hypotheses for spin” [24]. The CMS collaboration reports that, “all tested spin-one boson hypotheses are excluded,” [25] and, “any mixed-parity spin-one state is excluded” [26]. Neither collaboration reports that they have ruled out spin-1 in the model-independent case of Lorentz invariance, or even that they have studied it.

In further contradiction to the claims of certain detractors of the MCM, Particle Data Group (PDG)—the de facto bottom-line authority on the state of the art in particle physics—reports that the spin of the Higgslike particle was not yet determined as of 2020. PDG writes the following [27].

“Whereas the observed signal is labeled as a spin-0 particle and is called a Higgs Boson, the detailed properties of H^0 and its role in the context of electroweak symmetry breaking need to be further clarified. [...] The observation of the signal in the $\gamma\gamma$ final state rules out the possibility that the discovered particle has spin 1, as a consequence of the Landau–Yang theorem. This argument relies on the assumptions that the decaying particle is an on-shell resonance and that the decay products are indeed two photons rather than two pairs of boosted photons, which each could in principle be misidentified as a single photon.”

Regarding the Landau–Yang theorem, experiment trumps theory. Indeed, experiments are carried out mainly with the intention to falsify theories. Landau–Yang would go out the window if an experimental result was found to disagree with it. While this theorem is well trusted, theory can never rule out reality. Ralston writes the following regarding the dominion of experiment over theory [20].

“The Landau–Yang theorems are inadequate to eliminate spin-1. Theoretical prejudice to close the gaps is unreliable, and a fair consideration based on experiment is needed. A spin-1 field can produce the resonance structure observed in invariant mass distributions, and also produce the same angular distribution of photons and ZZ decays as spin-0. However

spin-0 cannot produce the variety of distributions made by spin-1. The Higgs-like pattern of decay also cannot rule out spin-1 without more analysis. Upcoming data will add information, which should be analyzed giving spin-1 full and unbiased consideration that has not appeared before.”

It is unusual that ten years have gone by since the particle was discovered and the “unbiased consideration” has not yet appeared in the literature (to the knowledge of this writer.) Considerations published by ATLAS [22–24] and CMS [25, 26] are biased under the suppositions of one model or another. While it seems impossible, the literature appears to suggest that the model-independent case has not yet been considered. What does seem possible is that the model-independent case *has* been considered, and the result has been withheld due to politics. Indeed, we suggest that the particle is “labeled” as a spin-0 particle and “called” a Higgs boson [27] mainly to further a false impression that the MCM prediction for spin-1 has been ruled out. Usually, physicists are zealously and notoriously reluctant to jump to conclusions, but not in this case.

Just months after the MCM prediction for spin-1 [6], Ellis and You wrote the following [28].

“There are many indirect and direct experimental indications that the new particle H discovered by the ATLAS and CMS Collaborations has spin zero and (mostly) positive parity, and that its couplings to other particles are correlated with their masses. Beyond any reasonable doubt, it is a Higgs boson[.]”

This excerpt may contain the only reference in the entirety of the physics literature to the formal standard of proof in USA jurisprudence: reasonable doubt. A more common standard in physics is given by the motto of the Royal Society: *Nullius in verba*. It means “take nobody’s word for it.” Ellis and You make their bold and patently unscientific claim in the abstract of their paper, but they back off from the outrageous overstatement in the paper’s first sentence [28].

“It has now been established with a high degree of confidence that the new particle H with mass ~ 126 GeV discovered by the ATLAS and CMS [*collaborations*] has spin zero.”

This paper of Ellis and You is remarkable not only for its reference to some ill-defined and unquantifiable standard of “reasonable doubt” in place of physics’ usual 5σ criterion, but also because it was the first citation of the Royal Swedish Academy

of Sciences in their technical write-up regarding the 2013 Nobel Prize in Physics [29]. The prominent citation by the Royal Swedish Academy of Sciences can be construed as an endorsement of the false claim that the Higgslike particle is the Higgs boson *beyond a reasonable doubt*. Aside from the reasonable doubt cast by the MCM prediction for spin-1, Ralston has reported that an entirely indeterminate amount of doubt remains [20]. PDG cites an uncertain number of photons *and* a questionable assumption about the on-shell condition as reasonable sources of doubt. Most importantly, PDG only cites known unknowns as sources of doubt when unknown unknowns may give reason to doubt as well.

Almost two years after Ellis and You published, CMS reported with atypical bluntness that it was still important to study the spin-1 case experimentally because the observed state *may be that one* [26].

“Despite the fact that the experimental observation of the $H \rightarrow \gamma\gamma$ decay channel prevents the observed boson from being a spin-one particle, it is still important to experimentally study the spin-one models in the decay to massive vector bosons in case that the observed state is a different one.”

It is not clear whether CMS suggests (*i*) the existence of a second, different particle at $\sim 125\text{GeV}$, (*ii*) that the observed one is different than the one ruled out by the Landau–Yang theorem, or (*iii*) that the final state is different than $\gamma\gamma$. CMS’ obtuse language about “a different one” is consistent with a theme of sidestepping the spin-1 issue in the literature. Even while CMS emphasizes the importance of experimental study, they still call the $H \rightarrow \gamma\gamma$ decay a fact while PDG reports that this channel is not yet established as a fact [27]. Assuming that it is a fact, as it may be, CMS does not state their reliance on the assumed perfection of the Landau–Yang theorem to find that such a decay prevents spin-1.

If reasonable doubt were to have some meaning in physics, then it could only be the usual standard of 5σ . However, there does not exist any literature claiming to have ruled out spin-1 at that level. Certain models of spin-1 have been ruled out to certain levels, but the model-independent, objective property of spin-1 has never been ruled out for the Higgslike particle at any high significance, and never at 5σ . Most likely, the reference to the reasonable doubt standard of USA jurisprudence was used to establish in a court of USA law, for some (nefarious) reason, that this writer’s prediction was wrong. In fact, spin-1 has not been ruled out. Any publication claiming that spin-1 has been ruled out will be found to have ruled out only certain models of spin-1 divorced from the case of model-independent Lorentz invariance [20]. Ten years later, one would think that the particle’s discoverers would have determined

its spin. To this writer's knowledge, no other particle's spin was so elusive that it could not be determined even ten years after the initial discovery. In the opinion of this writer, the Higgslike particle *has* been determined to have spin-1, and CERN withholds the result because it supports the MCM over work which is better loved in the academic mainstream.

Moving along, another falsifiable MCM prediction was posed in [30]. It was suggested that one might observe variations in the value of the fine structure constant correlated with the delay between an event and its detection in some apparatus. The unstated but implicit reasoning was that the quantum state space of things which existed in the past is not the same as the state space of things which exist in the present. Therefore, observables might depend on how far into the past an event occurred prior to its detection. Such was already the case for an earlier MCM result regarding dark energy [31]. Namely, distant cosmological objects appear to accelerate due to their displacement far back on the light cone (Section 7). Though the unit cell was not constructed until about a year after the quantum delay prediction appeared in [30], the unit cell elucidates the motivation for delay correlations and complements it with further motivation. Signals from events in the past are usually thought to propagate into detectors along paths in topological Minkowski space. In the MCM, in addition to an altered state space in the past [30], the past is not totally Minkowski in the unit cell. Due to the MCM's fifth dimension, one may speak of earlier *chronological times*, which are Minkowski, as well as earlier *chirological times* in which the past is topologically anti-de Sitter. (Chronological time is the timelike coordinate x^0 in 4D spacetime, and chirological time is a new fifth coordinate χ_{\pm}^4 .) Propagation through some non-Minkowski geometry will cause deviations from the predictions for pure Minkowski propagation, and these deviations should be correlated with the amount of time spent in the non-Minkowski geometry. This prediction is not so precise as the prediction that the Higgslike particle should have spin-1, but it is a strong prediction. If such delay correlations are not observed, then the fundamental ideation behind the prediction would be falsified. The predicted correlations *were* observed, by the BaBar collaboration [32], however!

The main gist communicated here to the reader is that all of the verifiable ideation in the MCM has survived: the specific things and the less specific things. More than 99% of new theories can be rejected immediately due to some obvious physical problem, so it is a great accomplishment of the MCM not to be one of them. Often laypersons hear that new theories are a dime a dozen, which is true, but this glosses over a further notion that is more relevant in the present case: a new theory that can

survive even a cursory check is a diamond in the rough. Almost none of them make it past a single hurdle. Ones that do are often absurdly convoluted. Quintessence and the chameleon field are examples of convoluted theories being not so convoluted that they are immediately discarded. Even the modern theory of cosmological inflation, which is not easy to rule out, is rather convoluted [33]. To the contrary, the MCM is elegant, intuitive, and simple, though not yet mathematically formalized with new equations of motion. Still, there is no trivial way to rule out the MCM, as is the case for almost all new theories. This testifies to the good quality of the work. Beyond the lack of an easy rejection, the MCM's predictions have *multiple experimental confirmations*, such as the prediction for delay correlations. These confirmations obliterate detractors' persistent claims of wrongness and not-even-wrongness.

The BaBar experiment concluded in 2008. The primary analysis of the data generated by the experiment had also concluded by the time of the MCM delay prediction. However, the search for these correlations in the BaBar data was undertaken immediately following the publication of the MCM prediction. Not astonishingly, the MCM prediction was borne out when BaBar published their observation of time reversal symmetry violation in the B^0 meson system [32]. While the BaBar analysis did not exactly search for the delay correlations in the value of the fine structure constant α which had been suggested, the result follows. Since physics is Hamiltonian, meaning that everything is calculable once any two things are determined, the value of α that can be extracted from the delay correlations published in [32] will depend on the delay. The observation of time reversal symmetry violation is easily the 21st century's second biggest discovery in particle physics after the Higgslike particle. This discovery is a direct experimental verification of the structure of the MCM.

During the primary data analysis stage following BaBar's data collection stage, no one had the idea to check for correlations with delay. After it was suggested that the MCM would be such that delay correlations should exist, someone at BaBar checked and found a signal that had escaped detection. No one had any reason to expect such correlations, but then time reversal symmetry violation was discovered, and the history of physics was changed forever. If the Higgslike particle is eventually reported to have spin-1, then the 21st century's biggest and second biggest particle physics discoveries will be among the MCM's small handful of falsifiable predictions. Not only that, the MCM also predicts (among even more things) the dark energy effect whose discoverers were awarded the 2011 Nobel Prize in Physics: Perlmutter, Schmidt, and Riess [34–36]. So, there is a decent volume of ordinary physics output recorded in the publications constituting the MCM. The lack of an easy falsification

among these predictions makes the MCM better than 99% of similar attempts to bushwhack a new path. The confirmation by BaBar makes the MCM the best new theory on the market today, bar none. Unfortunately, BaBar does not credit the ideation for delay correlations to this writer, and the ordinary scientific proceedings are retarded.

The predictions above, and others mentioned below, are intermingled with other content in MCM publications. Some of that content is non-standard. Why the weird tone? After this writer became convinced that his work was blacklisted against appearing even on the unreviewed arXiv, a tone was adopted which could never pass peer review, even in the absence of blacklisting. Despite the presence of outstanding original work, the tone in many MCM publications is such that they could never appear in physics' usual venue for the dissemination of scientific information. Although the MCM's many grand successes form an independent rebuke, the non-standard content and tone was added as a second rebuke so that this writer could be seen doubly rebuking the establishment which prefers the political mechanisms of the USA to the actual practice of science. Following these earlier MCM publications, the present work lays out a series of problems whose write-ups should be sufficiently technical so that the tone of the papers cannot be confused or conflated with the results. As mentioned above, the technical treatment of the problems should rise in many cases to the level of a PhD thesis. To date, it has been easier for detractors to conflate the author's prose with his main results due to an absence of such clearly demonstrated, PhD-level technical mastery or a commensurately voluminous set of calculations.

This writer has not been able to publish even on arXiv: the unreviewed (yet censored) preprint repository in which low quality work is published every day (along with many fair or outstanding research papers in physics and mathematics.) Before the non-standard tone was adopted, [31] was submitted to arXiv in September of 2009. The typesetting and graphics were substandard, the tone was ordinary, and the content was top-tier. For some reason most likely related to a payment routed through Cyprus to Paul Manafort in October of 2009 [37], the paper was rejected for publication on arXiv.¹ Details relating to the publication status of [31] may be found in Appendix C.

The overall lack of peer review for the MCM, which is a subset of the censorship problem at arXiv and elsewhere, provides more fodder for detractors. Even the most outlandish and easily disproven models of alternative physics have extensive online documentations including Wikipedia articles and various forum discussions,

¹For placement of [31] on the spectrum of what is acceptable in the physics preprint literature, compare to [38,39], particularly Figure 12 in the latter.

e.g.: *timecube*, but the relative invisibility of the MCM on the internet suggests that the publication blacklist exceeds blacklisting in the traditional publication venues. As a scientist, a physicist's trade is to ply the scientific method whose final step is *communicate results*, but the blacklisting seems to go so far as the total prohibition of this writer's intention to communicate. The fake internet bubble in which this writer appears to transmit results while ultimately failing to do so, for the most part, has had a stronger negative impact on this writer's career than any number of stylistic writing choices ever could. Still, this writer's research does get communicated, somehow. Reference [31] is now called SCP-001 in certain corners of the internet where the MCM is known to exist.

The supposition, or *allegation*, that the MCM has not passed peer review is false. Before moving on to a review of the MCM unit cell and its labeling conventions (Section 0.2), followed by a review of the MCM scheme for fundamental particles (Section 0.3), we will summarize the extensive peer review of the MCM and its glowing yet uncredited receptions. The MCM began as a work in phenomenology. Given certain results, a model of cosmology was constructed to accommodate them [31]. The optical effect described as dark energy was explained without an anomalous (and borderline unphysical) acceleration of the expansion of the 3D spatial universe. Instead, accelerating expansion in the time sector of 4D spacetime was identified as the cause of the observed optical effect. This was the kernel of the idea that things in the past should not be exactly as they are in the present. In [40], inquiry into the structure of the past was taken all the way back to the cosmological beginning. Since a famous theorem of Arnowitt, Deser, and Misner [41, 42] proves that the 0-component of the universe's 4-momentum must be non-zero, the usual model of big bang cosmology cannot conserve 4-momentum. Given a presumed $p^\mu = (0, 0, 0, 0)$ before the big bang, $p^\mu(t) = (p^0, p^1, p^2, p^3)$ at $t > 0$ cannot conserve momentum if $p^0 \neq 0$. However, physics requires that momentum is conserved. In the way that Pauli was able to deduce the existence of the neutrino from a quantity of missing momentum in nuclear β decay, it was deduced that a big bang would have to spawn two universes moving oppositely through time if it was a momentum-conserving process. If the energy of one universe is positive-definite, then the other universe (whose time has a minus sign on it) would be negative-definite. This is required to conserve 4-momentum, as is usual in physics.

After the proposition for negative time was published in November 2011 [40] (as a restatement of the same idea published in 2009 [31]), Rubino and McLenaghan et al. reported an experiment regarding negative frequency in quantum optics [43]. Since frequency is inverse time, and since the experiment was reported only months

after negative time was found to resolve the momentum problem in big bang cosmology, we suggest that the ideation for the experiment of Rubino and McLenaghan et al. followed after a review of early work in the MCM [31, 40]. Short of experimental verification, it is the highest and most valid form of peer review that one man's research should influence another man's research direction. Many papers passing ordinary, administrative peer review go on to accumulate zero citations, but papers well received by the community of experts in that area go on to acquire citations. If not for the apparent USA-sponsored blacklisting of this writer, it is suggested that Rubino and McLenaghan et al. might have cited [31, 40] as motivating their search for physical negative frequency modes. What peer review can be higher than to have one's work received and built upon? The answer cannot be a layer of dust atop an unknown, but peer reviewed, CV item.

Spawning new scientific inquiry among one's peer community is nearly the highest form of peer review. It far surpasses the administrative peer review which is widely hated by academics [44] and yet revered as holy by those who are only indirectly aware of the mechanism. Surpassing even positive reception in one's community, the highest mark in peer review is experimental confirmation. Rubino and McLenaghan et al. write the following about their discovery of negative frequency resonant radiation (NRR) [43].

“ $[F]$ requency conversion processes may be understood in terms of energy transfer between specific modes [...]. However, to date only the positive frequency branch of the dispersion has been considered when this actually also has a branch at negative frequencies. This branch is usually neglected or even considered meaningless when, in reality, it may host mode conversion to a new frequency. The fact that a mode on the negative branch of the dispersion relation may be excited has a number of important implications, beyond the simple curiosity of the effect in itself. Indeed, light always oscillates with both positive and negative frequencies, but the negative-frequency part is directly related to its positive counterpart and seems redundant. On the other hand, light particles, photons, have positive energies and are associated with positive frequencies only. A process such as that highlighted here, that mixes positive and negative frequencies will therefore change the number of photons, leading to amplification or even particle creation from the quantum vacuum.

“In this work we show how alongside the usual resonant radiation spectral peak observed in many experiments, a second, further blue-shifted peak

is also predicted. This new peak may be explained as the result of the excitation of radiation that lies on the negative frequency branch of the dispersion relation. We first explain why this radiation should be observed and then provide experimental evidence of what we call ‘negative frequency resonant radiation’ in both bulk media and photonic crystal fibres.”

NRR is a direct confirmation of the theory of negative time at the heart of the MCM. Although the existence of these negative frequency modes had been known for a long time, no one thought to look for them until the theory of negative time was published [31, 40]. Perhaps history will show that this was only a coincidence. In any case, we suggest that the negative frequency experiment was motivated by a review of the MCM, and that the experiment confirmed the negative time hypothesis through the observation of negative frequency optical modes.

To the extent that Rubino and McLenaghan et al. cite the possibility for “amplification,” consider the following from a follow-on publication of Rubino et al. in late 2012 [45].

“[*W*]e may derive a photon number balance equation by generalizing [...] to the case of a moving scatterer. We find that:

$$|\text{RR}|^2 - |\text{NRR}|^2 = 1,$$

where $|\text{RR}|^2$ and $|\text{NRR}|^2$ are the photon numbers of the [*resonant radiation*] and [*negative resonant radiation*] modes normalized to the input photon number [...]. The negative sign in front of the $|\text{NRR}|^2$ photon number is a direct consequence of the fact that the NRR-mode has negative frequency in the comoving reference frame [...]. So the difference between the normalized number of photons has to be equal to the photon number in the input mode. As a consequence, the total output photon number, $|\text{RR}|^2 + |\text{NRR}|^2 > 1$, i.e. ***we have amplification*** [*emphasis added*]. The scattering process mediated by the traveling [*relativistic inhomogeneity*] will amplify photons as a result of the coupling between the positive and negative frequency modes.”

As we have previously commented on the eccentric citation of Ellis and You to the legal standard of doubt in USA jurisprudence, the note at the top of [45] (not excerpted) is also eccentric. It is the only instance of such a note that this writer has come across.¹ The note directs that correspondence and requests for materials

¹This writer does not regularly browse the experimental quantum optics literature.

should be addressed to coauthor Faccio. The eccentric note in anticipation of correspondence is given because [45] reports that the authors discovered free energy. The negative frequency optical mode which follows from the negative time mode in the MCM—following logically and chronologically—revealed the holy grail of physics: a feasible mechanism for the construction of a device whose coefficient of efficiency exceeds unity. While the MCM did not predict the application in quantum optics, it follows because negative frequency is inverse negative time. It is suggested that this writer’s peers saw that it follows, did the experiment, and confirmed the physics. Thus, the MCM has yet again passed the true bar of review by peers without passing the false bar of administrative peer review under the docents of a politicized bureaucracy. The MCM has been experimentally confirmed at least twice. If the Higgslike particle has spin-1, it will be at least three times. Next to experimental confirmation, administrative peer review is meaningless. If it was suggested that objects on Earth tend to fall in the downward direction, no one would ask if the claim has passed peer review. For the MCM, however, the fact that it has not passed peer review in the most artificial and useless sense is cited as problematic to the extent that it overrides the experimental verification.

Following the work of Rubino et al. on NRR [43,45], Lockheed abruptly announced in 2014 near-term plans for truck-sized nuclear fusion reactors [46]. Fundamentally, Lockheed was front-running their expectation for the mass production of NRR power generators which would be truck-sized because they are only optical tables in a box (in the opinion of this writer.) After Lockheed’s initial press releases, the West Texas oil contract cratered in 2014, and it had not recovered as of 2021.¹ The blacklist on the MCM was extended by the powers that be to cover up the only hope by which humanity might escape its shackles of toil: a new energy source. These results regarding free energy are now known in certain corners of the internet as “golf rumors.” The quoted name follows from men at their country clubs talking about the NRR result before the full violence of the USA political machine squashed such talk.

The discovery of negative frequency resonant radiation by Rubino et al. [43, 45] suggests that the MCM has passed peer review with flying colors. The result about time reversal symmetry violation published by BaBar does the same [32]. Both of these results connect to the MCM’s requirement for negative time, through negative frequency and time reversal respectively. Both results are experimental confirmation of the MCM in excess of an affirmative peer review by positive reception leading to follow-on work. Additionally, there are no results which rule out the MCM predictions

¹During the preparation of this manuscript, the WTI oil contract reached highs not seen since 2014.

for new effects at 10^{-4}m , the prediction that the Higgslike particle should have spin-1, or any other features of the model. The many MCM mechanisms described in [31] are each likely to be parlayed into further experimental confirmations. Additionally, there are many mathematical confirmations. For example, the MCM search for quantum gravity shows that Einstein’s equation for general relativity may be derived in a certain quantum formalism (Section 1.10). A number alike to the fine structure constant to within 0.4% is characteristic of this formalism as well (Section 1.9), and the Riemann hypothesis was falsified as a corollary of mathematical results developed for describing physics in the unit cell [2,47–49]. Other examples of affirmative review by peers include the following.

- Ashtekar’s response papers [50,51] which are detailed at length in Appendix C.
- Wilczek’s 2012 quantum time crystals [52,53] follow from the 2011 \hat{M}^3 operator developed in [30].¹ The MCM unit cell is the unit cell of a time crystal in the most intuitive way (Section 57).
- Almost all of Finkelstein’s arXiv publications are MCM response papers (Section 33).
- Mochizuki’s “Hodge theater” is the MCM unit cell dressed in a thick coat of jargon (Section 31).
- Hairer’s \$3M Breakthrough Prize-winning “regularity structure” [54] is the unit cell dressed in another coat of jargon (Section 32). When Hairer’s colleague reported that Hairer’s Fields Medal-winning work must have been done by *aliens* [55], it was a jibe regarding how obviously Hairer had used the MCM and its \hat{M}^3 operator without citation. Apparently, those on the far side of the MCM blacklist see something akin to aliens between them and this writer.
- The RBM model in the autodidactic universe of Alexander et al. [56] is plainly the process given by \hat{M}^3 .

The list of such glowing yet uncited peer reviews goes on and on. It must exceed those few papers which have come to this writer’s attention.

0.2 The MCM Unit Cell

This section contains a glossary of symbols pertaining to the MCM unit cell: Figure 1. Remarks on its most prominent features are given in context. We will begin with the

¹This writer became aware of viXra in the summer of 2012. The viXra submission dates of References [30,31,40] do not reflect the initial publication dates.

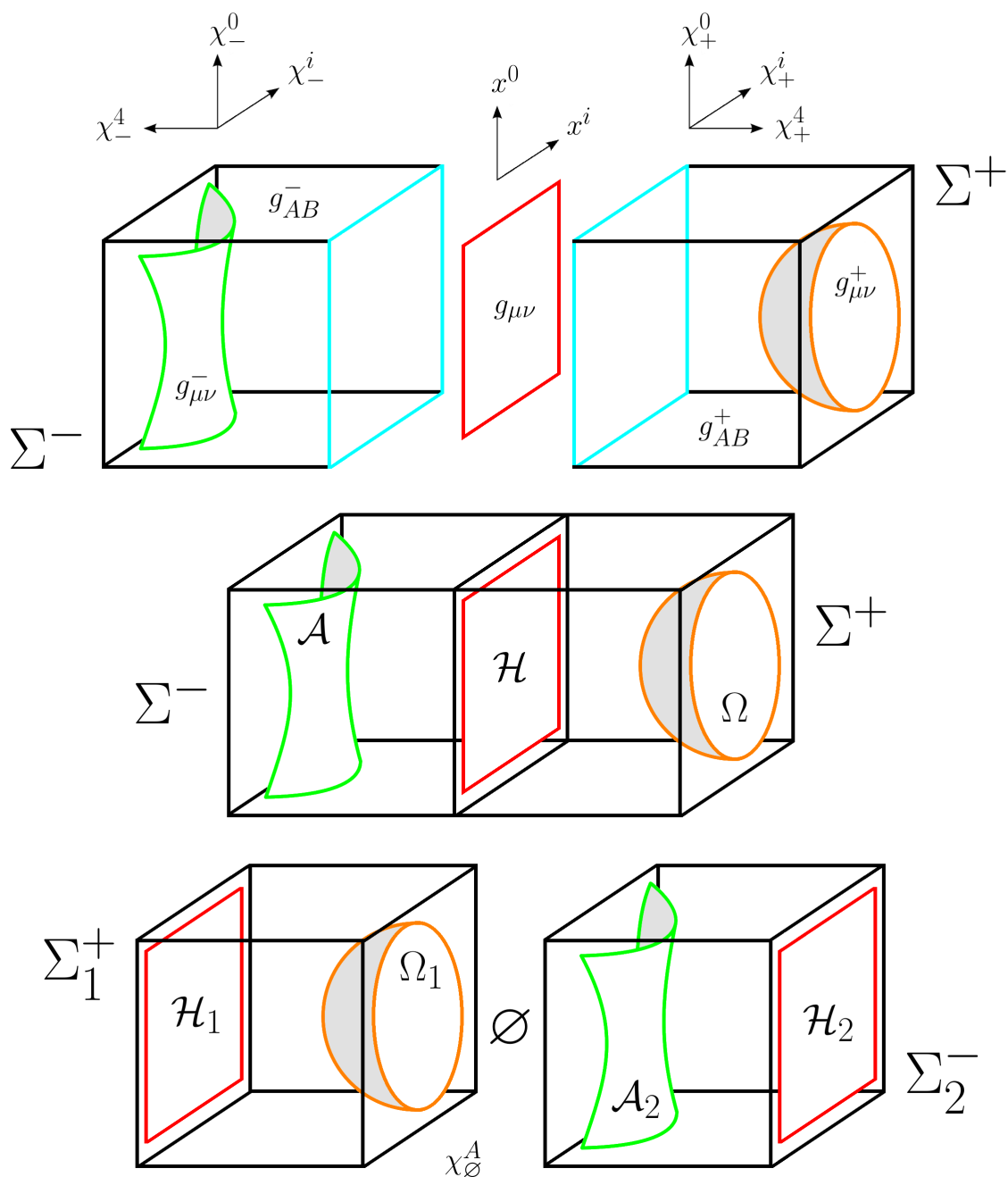

Figure 1: The MCM unit cell is the fundamental element of a cosmological lattice. \mathcal{H} is a Minkowski space representing the observable universe. Σ^\pm do not include their shared boundary at \mathcal{H} . It is expected that the χ_-^A coordinates are left-handed if the χ_+^A coordinates are right-handed. The second figure with Σ^\pm joined on \mathcal{H} is most properly the unit cell in the sense of crystallography, but often *unit cell* will refer to the representation centered on \emptyset .

unit cell's metric and coordinate conventions, and then further remarks will follow. Notation is such that Greek tensor indices run from 0 to 3. Upper case Latin indices run from 0 to 4. Lower case Latin indices run from 1 to 3.

- A^μ is the electromagnetic potential 4-vector. This object has its usual meaning. We will usually assume $A^\mu = 0$ to facilitate consideration of the simplest cases which can be extended to $A^\mu \neq 0$ later.
- A_\pm^μ are electromagnetic potential 4-vectors in Σ^\pm . Usually, descriptions of the MCM assume an $A_\pm^\mu = 0$ ground state.
- Σ^\pm are 5-spaces bounded in the fifth direction. The fifth coordinate is positive-definite in Σ^+ and negative-definite in Σ^- . The metric signature of Σ^\pm is $\{- + + + \pm\}$.
- χ_\pm^A are the 5D coordinates in Σ^\pm . Coordinates written with χ are called **abstract coordinates** to distinguish them from **physical coordinates** written with x . Different coordinate charts' distances are measured with different metrics. Although $\chi_\pm^4 = 0$ will be undefined, the origins of χ_\pm^4 are located in \mathcal{H} in the sense that χ_\pm^4 measure distance relative to \mathcal{H} . χ_\pm^4 is respectively positive- or negative-definite in Σ^\pm .
- χ_\pm^α are the abstract coordinates of Σ^\pm at some constant value of χ_\pm^4 .
- χ_\emptyset^A or χ_\emptyset^α are the hypothetical coordinates to the right of Ω and to the left of \mathcal{A} , as in the lower representation of Figure 1. In previous usage, χ_\emptyset^4 has referred to a single point added to splice χ_+^4 with χ_-^4 between Ω_1 and \mathcal{A}_2 . Similarly, a hypothetical $\chi_\pm^4 = 0$ would splice χ_\pm^4 at \mathcal{H} . However, $\chi_\pm^4 = 0$ is not defined due to the positive- and negative-definiteness of $\chi_\pm^4 \in \Sigma^\pm$. The exact details for connecting Ω_1 to \mathcal{A}_2 form one of the major outstanding problems in the MCM. Since the **level of aleph** (Section 1.6) changes at \emptyset , meaning that \emptyset marks the progression from one neighborhood of fractional distance to the next (Section 1.6), the pointlike property of χ_\emptyset^4 on one level of aleph may be resolved in greater detail as an interval on another level of aleph. For this reason, it is supposed that \emptyset might span a 5-space requiring χ_\emptyset^A coordinates rather than χ_\emptyset^μ . The exact details of \emptyset are not yet fully determined.
- x^μ are the physical, relativistic coordinates of the geometric manifold \mathcal{H} , a Minkowski space. Distance between the points specified with x^μ is given by the metric $g_{\mu\nu}$. These coordinates have their usual meaning.

- x_{\pm}^{μ} are the physical coordinates of gravitational manifolds located in Σ^{\pm} at constant values of χ_{\pm}^4 . x_{+}^{μ} charts Ω at $\chi_{+}^4 = \Phi$ and x_{-}^{μ} charts \mathcal{A} at $\chi_{-}^4 = -\varphi$. Φ is the golden ratio, and φ is its inverse. The Ω and \mathcal{A} manifolds are also charted in the abstract χ_{\pm}^{μ} coordinates, so it is required to carefully distinguish between the physical coordinates x_{\pm}^{μ} and the abstract coordinates χ_{\pm}^{μ} . Occasionally, we may speak of x_{\pm}^{μ} as the physical coordinates at arbitrary constant values of χ_{\pm}^4 .
- $g_{\mu\nu}$ is the metric of 4D Minkowski space \mathcal{M}_4 . If $g_{\mu\nu} = \eta_{\mu\nu} + h_{\mu\nu}$ with $\eta_{\mu\nu}$ the flat Lorentzian metric and $h_{\mu\nu}$ a small perturbation, we will almost always assume $h_{\mu\nu} = 0$. In the general case, this metric is to be determined from a matching condition on the metrics in Σ^{\pm} where a mismatch will result in $h_{\mu\nu} \neq 0$.
- g_{AB}^{\pm} is the 5D metric of the abstract χ_{\pm}^4 coordinates in Σ^{\pm} . It is based on the Kaluza–Klein metric

$$g_{AB}^{\text{KK}} = \begin{pmatrix} g_{\alpha\beta} + \kappa^2 \phi^2 A_{\alpha} A_{\beta} & \kappa \phi^2 A_{\alpha} \\ \kappa \phi^2 A_{\beta} & \phi^2 \end{pmatrix},$$

where ϕ is a scalar field, κ is a constant, and A^{μ} is an EM potential 4-vector. The g_{AB}^{\pm} metrics are obtained by identifying ϕ_{\pm}^2 in Σ^{\pm} with a function of the fifth abstract coordinate χ_{\pm}^4 . Setting $\kappa=1$, we have

$$g_{AB}^{\pm} = \begin{pmatrix} g_{\alpha\beta}^{\pm} + f_{\pm}(\chi_{\pm}^4) A_{\alpha}^{\pm} A_{\beta}^{\pm} & f_{\pm}(\chi_{\pm}^4) A_{\alpha}^{\pm} \\ f_{\pm}(\chi_{\pm}^4) A_{\beta}^{\pm} & f_{\pm}(\chi_{\pm}^4) \end{pmatrix}.$$

In general, we will assume that f is the identity function setting $\phi_{\pm}^2 = \chi_{\pm}^4$. Taking the simplest case of $A_{\pm}^{\mu} = 0$, we have

$$g_{AB}^{\pm} = \begin{pmatrix} g_{\alpha\beta}^{\pm} & 0 \\ 0 & \chi_{\pm}^4 \end{pmatrix}.$$

In Section 7, we will show that this metric supports an MCM solution to dark energy. Since χ_{\pm}^4 is positive or negative in Σ^{\pm} respectively, g_{AB}^{\pm} has Lorentzian signature $\{\mp \pm \pm \pm \pm\}$ in Σ^{+} and pseudo-Lorentzian signature $\{\mp \pm \pm \pm \mp\}$ in Σ^{-} . This signature is also supported by $\phi_{\pm}^2 = (\chi_{\pm}^4)^2$ if χ_{\pm}^4 is imaginary relative to χ_{\pm}^4 . Since the exact role for the MCM scalar field has not been fully developed, it will suffice to let g_{44}^{\pm} be oppositely signed as χ_{\pm}^4 with an understanding that we may later choose $\phi_{\pm}^2 = \pm |\chi_{\pm}^4|^2$.

- $g_{\mu\nu}^{\pm}(\chi_{\pm}^4)$ is the physical metric on a submanifold of Σ^{\pm} defined by some constant value of χ_{\pm}^4 . This metric describes distances in the physical x_{\pm}^{μ} coordinates. When $A_{\pm}^{\mu} = 0$, $g_{\mu\nu}^+(\chi_+^4)$ is the dS₄ de Sitter metric in Σ^+ and $g_{\mu\nu}^-(\chi_-^4)$ is the AdS₄ anti-de Sitter metric in Σ^- . The dS or AdS space at a given value of χ_{\pm}^4 is the one whose constant Ricci scalar R is equal to that value of χ_{\pm}^4 . In other words, the KK scalar field is such that ϕ^2 becomes the Ricci scalar of the maximally symmetric physical metrics.¹ $g_{\mu\nu}^{\pm}$ will implicitly refer to the $g_{\mu\nu}^+(\Phi)$ physical metric on Ω and the $g_{\mu\nu}^-(-\varphi)$ physical metric on \mathcal{A} .

To explain how the metric $g_{\mu\nu}$ in \mathcal{H} should be obtained from the g_{AB}^{\pm} metrics, we will make reference to a scale factor which has not been introduced yet. It will be covered in Section 1. We want $g_{\mu\nu}$ to be a superposition of contributions from g_{AB}^{\pm} , as in [7]. It should be the superposition of the limits of the 5D metrics as $\chi_{\pm}^4 \rightarrow 0$. Letting $A_{\pm}^{\mu} = 0$ and assigning scale factors Φ and φ to g_{AB}^{\pm} , the scaled sum of g_{AB}^{\pm} is

$$\Phi g_{AB}^+ + \varphi g_{AB}^- = \begin{pmatrix} \Phi g_{\alpha\beta}^+ + \varphi g_{\alpha\beta}^- & 0 \\ 0 & \Phi \chi_+^4 + \varphi \chi_-^4 \end{pmatrix} .$$

In the $\chi_{\pm}^4 \rightarrow 0$ limit, the fifth diagonal position vanishes. The fifth position is associated with the Ricci scalar and $R = 0$ defines Minkowski space. While the fifth diagonal position may have additional physics associated with its context as a scalar field, the metric in \mathcal{H} is presently defined as the 4D part of the metric superposition:

$$g_{\mu\nu} = \Phi g_{\alpha\beta}^+ + \varphi g_{\alpha\beta}^- = \begin{pmatrix} -\Phi c^2 & 0 & 0 & 0 \\ 0 & \Phi & 0 & 0 \\ 0 & 0 & \Phi & 0 \\ 0 & 0 & 0 & \Phi \end{pmatrix} + \begin{pmatrix} -\varphi c^2 & 0 & 0 & 0 \\ 0 & \varphi & 0 & 0 \\ 0 & 0 & \varphi & 0 \\ 0 & 0 & 0 & \varphi \end{pmatrix} .^2$$

To obtain a natural scale for the metric in \mathcal{H} , we might rephrase the expression as a difference, but instead we will appeal to the sign freedom in the $\{\mp \pm \pm \pm\}$ metric signature. We give the opposite sign convention to g_{AB}^- to obtain

$$g_{\mu\nu} = \Phi g_{\alpha\beta}^+ + \varphi g_{\alpha\beta}^- = \begin{pmatrix} -\Phi c^2 + \varphi c^2 & 0 & 0 & 0 \\ 0 & \Phi - \varphi & 0 & 0 \\ 0 & 0 & \Phi - \varphi & 0 \\ 0 & 0 & 0 & \Phi - \varphi \end{pmatrix} = \eta_{\mu\nu} ,$$

¹dS and AdS are called *maximally symmetric* because the Ricci scalar is constant in the manifold, and the geometry is completely determined by its value.

²Part of the reason for leaving $\chi_{\pm}^4 = 0$ undefined is to avoid a picture of $g_{\mu\nu}$ as the 4D part of a metric whose fifth diagonal position vanishes.

where $\eta_{\mu\nu}$ is the perturbation free case of $g_{\mu\nu}$ in signature $\{- + + +\}$. Due to the opposite sign conventions for the metrics in Σ^\pm , the metric in \mathcal{H} is both a superposition and a solitonic difference like a shadow cast by g_{AB}^\pm . This metric structure is expected to become rich when one adds non-zero $A_+^\mu \neq A_-^\mu$ to g_{AB}^\pm . The absence of the scale factor when this structure was proposed in [7] set the scale of \mathcal{H} as larger than the scale in either of Σ^\pm , so the present convention is more natural. A full metrical analysis remains to be carried out.

The method for obtaining the induced $g_{\mu\nu}^\pm(\chi_\pm^4)$ metrics on \mathcal{A} and Ω differs from the above method for obtaining $g_{\mu\nu}$ as a superposition. Part of the future work described in this paper will be to determine the transformations between the abstract and physical coordinates at constant χ_\pm^4 . (Such a transformation cannot exist at undefined $\chi_\pm^4 = 0$.) Cases for $A_\pm^\mu \neq 0$ should be developed to determine how the condition of maximal symmetry in dS and AdS is perturbed by non-vanishing EM. It is known that static dS or AdS geometry must be supported by a cosmological constant or a constant scalar field, so the energy associated with $A_\pm^\mu \neq 0$ should be a main driver of new MCM physics. However, the assumption $A_\pm^\mu = 0$ is useful for describing the model because it equips each slice of constant χ_\pm^4 with a *maximally symmetric* dS₄ or AdS₄ metric. Allowing non-zero A_\pm^μ will disturb this simplifying condition of maximal symmetry.

In [7], the original statement of the convention for embedding physical metrics on branes located at constant χ_\pm^4 confused the hyperboloid parameter ℓ^2 with the inversely proportional Ricci scalar R so that $\ell^2 = 0$ was associated with \mathcal{H} . In fact, $\ell^2 \rightarrow \infty$ and $R = 0$ are associated with flatness. This erratum now stands corrected. However, the convention in which χ_\pm^4 is a hyperboloid parameter rather a Ricci scalar suggests an alternative picture of χ_\pm^4 having their origins in \emptyset rather than \mathcal{H} so that $\chi_\pm^4 = 0$ would define a topological singularity of infinite curvature due to $\ell^2 = 0$. In later sections, we will show that it is useful to think of \emptyset as a black hole.

Now we will describe the labeled worldsheets of the unit cell. Anticipating an application in which these sheets function as string theoretical D-branes (Section 65), and referring to the picture of worldsheets as *membranes* arranged in a bulk, we will call these objects **branes**.

- \mathcal{H} is 4D Minkowski space \mathcal{M}_4 charted in x^μ . Up to a topological issue of global closure or openness, Minkowski space is the low curvature limit of de Sitter space and/or anti-de Sitter space. \mathcal{H} , also called “the \mathcal{H} -brane,” stitches together Σ^\pm at $\lim \chi_\pm^4 \rightarrow 0^\pm$. Up to a scale factor, \mathcal{H} can be smoothly joined to either of Σ^\pm . When $A_\pm^\mu = 0$ implies maximally symmetric spacetime in the physical metric at

each χ_{\pm}^4 , it is easy to envision a smooth continuum of increasing curvature where \mathcal{H} joins the low curvature limits of dS_4 and AdS_4 at a scale discontinuity. Since $\chi_{\pm}^4 = 0$ is not defined, which follows from χ_{\pm}^4 being positive- and negative-definite in Σ^{\pm} respectively, \mathcal{H} is a *topological obstruction* between Σ^{\pm} . In terms of the open sets of a mathematically formal topological space, no open set can include $\chi_{\pm}^4 = 0$ because it is not defined in the current iteration of the theory. Such a topological obstruction is required to separate the pair of Kaluza–Klein theories that double the EM degrees of freedom inherent to a single KKT.

- Ω is a specific worldsheet (the Ω -brane) in Σ^+ located at $\chi_+^4 = \Phi$ where Φ is the golden ratio. In the physical coordinates (with $A_+^{\mu} = 0$), Ω is dS_4 with open topology and uniform positive curvature. In Figure 1, Ω spans some width of the horizontal coordinate, but that is only meant to demonstrate the spherical geometry of the physical coordinates x_+^{μ} . Formally, Ω is a single sheet at one value of χ_+^4 , as would be \mathcal{H} if $\chi_{\pm}^4 = 0$ was defined.
- \mathcal{A} is a specific worldsheet (the \mathcal{A} -brane) in Σ^- located at $\chi_-^4 = -\varphi$ with $\varphi = \Phi^{-1}$. In the physical x_-^{μ} coordinates (with $A_-^{\mu} = 0$), \mathcal{A} is AdS_4 with closed topology and uniform negative curvature. In Figure 1, \mathcal{A} spans some width of the horizontal coordinate, but that is only a representation emphasizing the hyperbolic geometry of the x_-^{μ} coordinates. Previous work in the MCM has been such that the distance from \mathcal{H} to Ω should be either Φ or Φ^2 times that between \mathcal{A} and \mathcal{H} . Setting Ω at $\chi_+^4 = \Phi$, these conventions place \mathcal{A} at either $\chi_-^4 = -1$ or $\chi_-^4 = -\varphi$. Therefore, the abstract distances between \mathcal{A} and \mathcal{H} , and between Ω and \mathcal{H} , may be revised pending the adoption of another convention.
- \emptyset is an unknown connective element joining Ω and \mathcal{A} . It may be a 4D surface or a 5D volume. In general, there is no smooth connection from the Lorentzian $\{- + + + +\}$ metric in Σ^+ to the pseudo-Lorentzian $\{- + + + -\}$ metric in Σ^- . If we take \emptyset to be the worldsheet of a black hole, placement of a singularity at the interface between Σ^{\pm} might help wash out the discrepancy between their topologies. Increasing the curvature of the slices of Σ^{\pm} to the positive and negative infinite limits at \emptyset may make it easier to join non-vanishing positive and negative curvature on a singularity than it would be to join them on discontinuous but finite positive and negative curvatures. In other words, $R = \pm\infty$ Ricci scalars should be less discontinuous than finite $R_{\mathcal{A}} < 0 < R_{\Omega}$. Placing a black hole at \emptyset should minimize geometric *and* topological discontinuities between Ω and \mathcal{A} .

The standard cosmological model (SCM) describes a 4D spacetime: the universe. The SCM is cited as some generalized picture of the Friedmann–Lemaître–Robertson–Walker cosmology, or the more modern Λ CDM model. Either model is more specific than what is required to describe the MCM as an extension of an informally labeled SCM. Indeed, the MCM is more quantum mechanical in nature now than cosmological, and the exact details of an underlying standard cosmology, an equation of state for example, are not needed to describe the basic elements.

The main jumping off point for separating the MCM from the SCM was the implementation of a cyclic cosmology [31, 40]. Cyclic cosmology is a variant of big bang cosmology that assumes a *big crunch* at the end of things, and that the crunch serves as the big bang for a new cycle of cosmology. Sometimes it is said that cyclic cosmology is unphysical due to the observed thermodynamic state of the universe, but such issues can be sidestepped in a number of ways. The Borde–Guth–Vilenkin theorem [57] which claims to rule out an infinite timelike parameter in the past, which is required for infinite cyclic cosmology, is discussed in Section 45. Another argument claims that it is unphysical to identify the high entropy final state of one cosmology cycle with the low entropy initial state of an identical cycle, but the MCM is such that two universes converge on each bounce, one in forward time and one in negative time [31]. When the thermodynamic arrow of time points oppositely in each universe, the increment of entropy at the conclusion of one universe’s cycle is offset by the decrement of entropy in the other universe. Furthermore, there is little reason to think that cosmology is so well understood that theoretical arguments might categorically rule out exotic behaviors on cosmological time scales. Beyond that, the present incarnation of the MCM is not necessarily a model of big bang cosmology in any guise, cyclic or not, because the periodicity assigned at first to x^0 has been reimplemented along χ^4 . This writer considers it an open question whether or not the MCM in its current incarnation is a model of big bang cosmology at all. In other words, it is not yet determined whether the added periodicity in χ^4 has replaced the previously supposed x^0 periodicity, or if it has complemented it. In the absence of cyclic cosmology, eternal cosmology is a viable alternative.

Motivated by a brief survey of KKT in 2013, the MCM’s fifth dimension was added a few years after the 2009 publication of the paper which gives the MCM its name [31]: “Modified Spacetime Geometry Addresses Dark Energy, Penrose’s Entropy Dilemma, Baryon Asymmetry, Inflation and Matter Anisotropy.” In the original MCM language [31, 40], the big bangs and/or big crunches of the SCM were replaced with *big bounces*. Bouncing is a periodicity in the x^0 direction: vertical on the page of

Figure 1. This writer was introduced to cyclic cosmology via the big bounces of loop quantum cosmology (LQC) [58], but the 2009 iteration of the MCM [31] contained nothing specific to LQC which is not found in all other models of cyclic cosmology. For the present version of the MCM unit cell, the main modification to the SCM is the fifth embedding dimension χ^4 . Overduin and Wesson write the following [8].

“Kaluza’s achievement was to show that five-dimensional general relativity contains both Einstein’s four-dimensional theory of gravity and Maxwell’s theory of electromagnetism. He however imposed a somewhat artificial restriction (the cylinder condition) on the coordinates, essentially barring the fifth one a priori from making a direct appearance in the laws of physics. Klein’s contribution was to make this restriction less artificial by suggesting a plausible physical basis for it in compactification of the fifth dimension. This idea was enthusiastically received by unified-field theorists, and when the time came to include the strong and weak forces by extending Kaluza’s mechanism to higher dimensions, it was assumed that these too would be compact. This line of thinking has led through eleven-dimensional supergravity theories in the 1980s to the current favorite contenders for a possible ‘theory of everything,’ ten-dimensional superstrings.”

Klein supposed that the fifth dimension might not contribute because it is compactified at an unobservably small scale. The MCM unit cell is purpose-built to motivate the cylinder condition by requiring that observable physics takes place only on surfaces of constant χ^4 . Derivatives with respect to the fifth dimension can’t contribute in \mathcal{H} due to an effective condition $\chi^4_{\pm} = 0$. The same holds for Ω and \mathcal{A} at constant χ^4_{\pm} . All derivatives with respect to a constant vanish.

Another shortcoming of KKT highlighted by Overduin and Wesson [8]—the main one which prevented the success of KKT in its effort to unify gravitation with classical electromagnetism—is that the only allowable solutions require a vanishing electromagnetic strength tensor $F_{\mu\nu} = \partial_{\mu}A_{\nu} - \partial_{\nu}A_{\mu}$. It is hoped that doubling the number of EM degrees of freedom from four as in

$$g_{AB} = \begin{pmatrix} g_{\mu\nu} + \phi^2 A_{\mu} A_{\nu} & \phi^2 A_{\mu} \\ \phi^2 A_{\nu} & \phi^2 \end{pmatrix}, \quad \text{with} \quad A^{\mu} = (A^0, A^1, A^2, A^3),$$

to eight as in

$$g^{\pm}_{AB} = \begin{pmatrix} g^{\pm}_{\mu\nu} + f(\chi^4_{\pm}) A^{\pm}_{\mu} A^{\pm}_{\nu} & f(\chi^4_{\pm}) A^{\pm}_{\mu} \\ f(\chi^4_{\pm}) A^{\pm}_{\nu} & f(\chi^4_{\pm}) \end{pmatrix}, \quad \text{with} \quad A^{\pm}_{\mu} = (A^0_{\pm}, A^1_{\pm}, A^2_{\pm}, A^3_{\pm}),$$

will provide a workaround by which $F_{\mu\nu} \neq 0$ solutions can be extracted in \mathcal{H} from two disconnected Kaluza–Klein theories in Σ^\pm (Figure 1).

The MCM unit cell reflects the ground state condition in which $A_\pm^\mu = 0$, but it is expected that the non-zero A_\pm^μ solutions can be implemented as perturbations or more complicated exact solutions. The result for $A_\pm^\mu \neq 0$ will be that the \mathcal{H} -, \mathcal{A} -, and Ω -branes lose their shared character of *maximal* symmetry. In the $A_\pm^\mu = 0$ ground state, the piecewise fifth dimension χ_\pm^4 charts a continuum of increasingly curved, maximally symmetric physical spacetimes between \mathcal{A} and Ω disrupted only by a scale discontinuity at \mathcal{H} . This serves as a toy model upon which one would build more realistic applications. To make use of the expanded degrees of EM freedom in Σ^\pm , one must use A_\pm^μ to define A^μ in \mathcal{H} . This is implemented by a mechanism well known from classical EM: A^μ is taken as a function of the advanced and retarded potentials $A_{\text{adv}}^\mu = A_+^\mu$ and $A_{\text{ret}}^\mu = A_-^\mu$ [7]:

$$A^\mu = c_+ A_+^\mu + c_- A_-^\mu \quad .$$

The idea to have the physics of the observable universe \mathcal{H} defined by two 5D theories reflects a principle called holographic duality. This idea was made famous by Maldacena’s demonstration of a “correspondence” between the degrees of freedom in a 4D conformal field theory and those in AdS_5 [59]. The MCM flavor of “holographic duality” between the physics of a 4D surface and two adjoining 5D bulks is simpler than Maldacena’s famous AdS/CFT duality, but the duality is *holographic* nonetheless. The mechanism reflects exciting new thinking. Usually, holographic duality between a surface and a bulk is considered to be such that the surface is the exterior boundary of one simply-connected bulk, but the *fresh new idea* for holographic duality in the MCM is to sandwich a holographic surface between two bulks. This idea alone far separates the MCM from competing theories. It cannot be overstated that the MCM has accomplished what other theories have not due in large part to this original thinking in the red-hot area of bulk-boundary physics. Although this writer was not yet acquainted with Randall–Sundrum models (Section 42) when constructing the unit cell, the MCM is quite like a third class of RS model not considered by Randall and Sundrum. The two famous RS1 and RS2 models put branes at one side of a bulk or another—at infinity, finite distance, or zero in their given coordinates—but they do not consider the case of a brane set between two asymmetric bulks.

Before continuing on to the MCM particle scheme (Section 0.3), the reader’s attention is called to the reality that certain labeling conventions in the unit cell are chosen intuitively from among a few possible permutations. The purpose in this pro-

gram is to facilitate easy discussion that would be clouded by repeated clarifications for caveats about all possible permutations. Usually, the number of possible permutations is low, and the alternatives reflect little more than a sign change. For example, the assignment of dS or AdS geometry to the slices of constant $\chi_{\pm}^4 \in \Sigma^{\pm}$ respectively is only a sign convention. It is assumed that the trip from \mathcal{H}_1 to \mathcal{H}_2 goes through Ω , and then \mathcal{A} , but this is subject to reversal if needed. For instance, the cosmological constant is negative in AdS and positive in dS, and the energy landscape might override the assumed convention for which comes first. The fifth dimension is currently timelike in Σ^- and spacelike in Σ^+ , but if the opposite convention were desired, one would add a minus sign into the metric. If we were to move the origins of χ_{\pm}^4 from \mathcal{H} to \emptyset , then the natural sign conventions for χ_{\pm}^4 would be reversed, etc. In the end, we will require that binding energy is negative in \mathcal{H} , and that the entropy in \mathcal{H} tends to increase with increasing x^0 . Everything else should be arranged accordingly.

In addition to the geometric objects labeled in Figure 1 and detailed above, there are some algebraic objects of fundamental importance. We introduce new algebraic complexity by attaching different state spaces to the various labeled manifolds. For instance, $L^2(\mathbb{R}^3)$ is the well-known Hilbert space of square integrable functions of three real variables. L^2 describes the algebraic state space, and \mathbb{R}^3 describes the domain of the wavefunctions that are representations of the L^2 states. Using $\mathcal{H}' \equiv L^2(\mathbb{R}^3)$ to denote the space of position states in \mathcal{H} , \mathbb{R}^3 refers to the 3D spatial submanifolds of \mathcal{H} described by the $\{+++ \}$ part of \mathcal{M}_4 's $\{-+++ \}$ metric. We will use \mathcal{A}' and Ω' to label the state spaces of particles located on the \mathcal{A} - and Ω -branes. Although the wavefunctions of states in \mathcal{A} and Ω are also functions of three real variables, those variables do not chart the 3-space in the Euclidean metric δ_{ij} that is usually inferred from the \mathbb{R}^3 symbol. Formally, \mathbb{R}^3 is any tuple of three real variables and E^3 is Euclidean 3-space. These two symbols are often intermingled in physics where E^3 may be less familiar. Therefore, increased nuance is warranted for the labeling. With \mathcal{A} as AdS_4 and Ω as dS_4 , the domains of the functions in the \mathcal{A}' and Ω' state spaces are hyperbolic H^3 and spherical S^3 respectively.¹ We might write, for example, $\Omega' \equiv L^2(S^3)$ to indicate that the \mathbb{R}^3 coordinates in the domain of wavefunctions in Ω are not subject to the Euclidean metric as are wavefunctions in \mathcal{H} with $\mathcal{H}' \equiv L^2(E^3)$.

For reasons developed below, mainly to accommodate the eigenstates of observable operators with continuous spectra such as \hat{x} , we will introduce rigged Hilbert space to employ other algebraic spaces than L^2 for position states located in various sectors of the unit cell. Readers unfamiliar with rigged Hilbert space are referred to [60–62]. In

¹ AdS_3 and dS_3 refer to Lorentzian manifolds, meaning that these are not the spatial parts of AdS_4 and dS_4 . Rather, AdS_3 and dS_3 are manifolds spanned by one timelike dimension and two spacelike dimensions.

the following, we omit some nuance differentiating state spaces and function spaces.¹

- $\{\mathcal{H}', \mathcal{A}', \Omega'\}$ is a rigged Hilbert space (RHS), also called a Gelfand triple. \mathcal{H}' is a subspace of \mathcal{A}' . Ω' is a dual (or antidual) space to \mathcal{H}' which contains \mathcal{A}' as a subspace: $\{S_1, S_2, S_3\}$ such that $S_1 \subset S_2 \subset S_3$. In previous work, we have used the convention that RHS is $\{\mathcal{A}', \mathcal{H}', \Omega'\}$, but the structure of RHS suggests that S_1 is most appropriate for the manifold of physical observables [62]. That manifold is \mathcal{H} , so we have chosen the present convention for $\{\mathcal{H}', \mathcal{A}', \Omega'\}$. The previous convention in which the order of the spaces in the triple matched the order of the branes in the unit cell was intuitive, but it does not appear to be the one supported by the definitions.
- \mathcal{A}' is Hilbert space. In this book, the relevant Hilbert space is usually taken as the infinite dimensional Hilbert space of position states. In that case, \mathcal{A}' is the $L^2(\mathbb{R}^3)$ space of square integrable functions: wavepackets rather than the δ function position eigenstates. One might write this as $L^2(H^3)$ to indicate that the domain of these L^2 wavefunctions possesses hyperbolic geometry.
- \mathcal{H}' is a subdomain of Hilbert space $\mathcal{H}' \subset \mathcal{A}'$. Under certain conditions related to unbounded observable operators with continuous spectra such as the position operator \hat{x} , there exist states in $\mathcal{A}' \equiv L^2$ for which certain ordinary quantum mechanical identities fail. \mathcal{H}' is the subdomain of \mathcal{A}' in which things like the expectation value and uncertainty formulae are guaranteed to be well behaved for every state in the space. De la Madrid presents these details in [60–62]. Due to the stated properties of well behavior, the S_1 part of an RHS $\{S_1, S_2, S_3\}$ is attached to the 4D physical universe of observables: \mathcal{H} . The present convention contrasts the previous convention in which S_2 was attached to \mathcal{H} .
- Ω' is the dual (or antidual) space of \mathcal{H}' such that $\{\mathcal{H}', \mathcal{A}', \Omega'\}$ is an RHS. Eigenstates of operators with continuous spectra are non-normalizable Dirac δ functions, which do not exist in \mathcal{A}' or \mathcal{H}' . Such eigenstates, usually position eigenstates, belong to the state space Ω' satisfying $\mathcal{H}' \subset \mathcal{A}' \subset \Omega'$. As will be discussed in Section 1, predictions for what will happen in the future reside in Ω . Since the MCM seeks to restore a classical character of motion which was lost in quantum mechanics, meaning that a prediction for a time-advanced quantum position state should be a point in spacetime as was the case for classical motion, the S_3 part of the RHS $\{S_1, S_2, S_3\}$ containing Dirac δ wavefunctions is assigned to Ω and called Ω' .

¹Ballentine writes [63], “It is a matter of taste whether one says that the set of functions forms a representation of the vector space, or that the vector space consists of the functions $\psi(\mathbf{x})$.”

- \emptyset' is a hypothetical state space for states in the \emptyset -brane.

0.3 The MCM Particle Scheme

Early work in the MCM [31] posed a solution to the mystery of the matter asymmetry. That mystery regards why the universe is made of matter rather than anti-matter [64]. The issue is similar to a question about non-conservation of 4-momentum at the big bang. If nature is thought to conserve baryon number and 4-momentum, then why should the big bang not conserve both?¹ It was suggested in [31] that two universes leaving a big bang, or a big bounce, should be understood as an ordinary particle pair in the sense of pair creation by vacuum fluctuations. It is not known why any particular fluctuation occurs, but the particle production process is better understood than an alleged cosmological big bang process for a single universe with an anomalous increment of momentum and an anomalous baryon number. In the particle pair picture, the forward and reverse time universes are a particle and an anti-particle. One has positive baryon number and positive p^0 . The other has negative baryon number and negative p^0 . The MCM model of particles [6] follows from this notion: a universe, one quantum of MCM spacetime, is like a fundamental matter particle.

In the unit cell, our observable universe given positive baryon number B is the \mathcal{H} -brane. It is spanned by x^0 and x^i . The MCM particle scheme supposes that all fundamental matter particles are quanta of spacetime spanned by a spatial unit vector \hat{x}^i and a temporal one: \hat{x}^0 or $\hat{\chi}^4_{\pm}$. Given these two types of time in the MCM, chronological x^0 and chiological χ^4 , this thinking leads to the 12 well-known members of the three generations of matter particles.

Referring to Figure 1, space x^i points into the page. Chronos points up, and chiros points to the right.² The spanning bases for planar spacetimes are x^0x^i and χ^4x^i . The basis vectors in the respective directions can form left- or right-handed coordinate systems with the third member of $\{x^0, x^i, \chi^4\}$, so there exist four distinct varieties of MCM spacetime quanta: space crossed with either of chronos or chiros, each in left- and right-handed varieties, as in Figure 2. The planes of x^i crossed with the well-studied x^0 flavor of time are taken as the relatively well-behaved leptons. Space crossed with the exotic new chiological time is taken as a quark. We suggest that quantum electrodynamics (QED) is simple relative to quantum chromodynamics (QCD) because x^0 is simple relative to $\chi^4 \cong \{\chi^4_+, \chi^4_{\emptyset}, \chi^4_-\}$. The three color flavors of each quark are distinguished by the three varieties of χ^4 . We say quarks are never

¹Positive baryon number is associated with matter, and negative baryon number is associated with anti-matter. For historical reasons [64], the excess of matter over anti-matter is described as an excess of baryons over anti-baryons despite there being a similar excess of leptons over anti-leptons.

²In Greek, chronos and chiros refer to “man’s time” and “gods’ time” respectively.

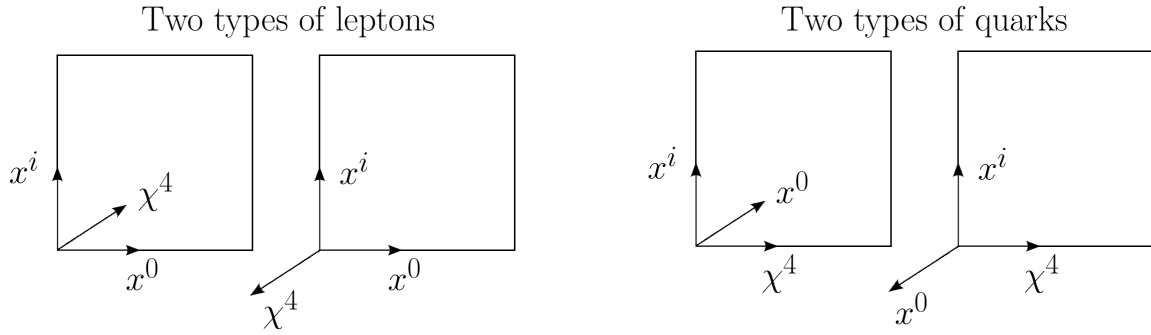

Figure 2: Leptons are planes formed by x^i and x^0 , while quarks are planes formed from x^i and χ^4 . Two varieties of each are formed when the unused instance of x^0 or χ^4 forms a right- or left-handed orthogonal triad. An alternative convention to handedness might distinguish each pair with the triad being located at zero or infinity. We will associate the three color charges of QCD with the $\{\chi_+^4, \chi_-^4, \chi_\emptyset^4\}$ varieties of chiros.

observed in isolation because the piecewise structure of χ^4 is such that χ_\pm^4 are each needed to construct an instance of the unit cell. The existence of Σ^\pm implies the coexistence of Σ^\mp .

Having established two leptons and two quarks (Figure 2), the three generations of each are associated with the \mathcal{H}' , \mathcal{A}' , and Ω' state spaces, as in Figure 3. In the final analysis, the primary distinction among the three generations may be attributed most directly to the three different lattice positions $\{\mathcal{A}, \mathcal{H}, \Omega\}$, or to the three different state spaces $\{\mathcal{H}', \mathcal{A}', \Omega'\}$. The three generations of matter particles reflect the structure of the unit cell, but the full details of the MCM state spaces are not yet finalized. Thus, it cannot be determined at this time if the three generations of particles follow more directly from algebraic distinctions among $\{\mathcal{A}', \mathcal{H}', \Omega'\}$ or geometric distinctions among $\{\mathcal{A}, \mathcal{H}, \Omega\}$. Presently, the three generations of leptons and quarks are increasingly massive, and we would like to associate this property with the $\mathcal{H}' \subset \mathcal{A}' \subset \Omega'$ structure of RHS. Since electrons are stable in \mathcal{H} while muons and taus are not, this suggests the convention in Figure 3: \mathcal{H}' should be the state space corresponding to the first, lightest generation of matter particles. Associating increasing mass with increasing scale factor across the unit cell centered on \emptyset would suggest Ω for the second generation particles. Perhaps the three generations of matter particles observable in \mathcal{H} would be better associated with Ω , \emptyset , and \mathcal{A} in an alternative, similar convention. Most importantly, it is emphasized that the permutations of the unit cell match the permutations of the particles.

Another consideration for the MCM state space structure regards lepton univer-

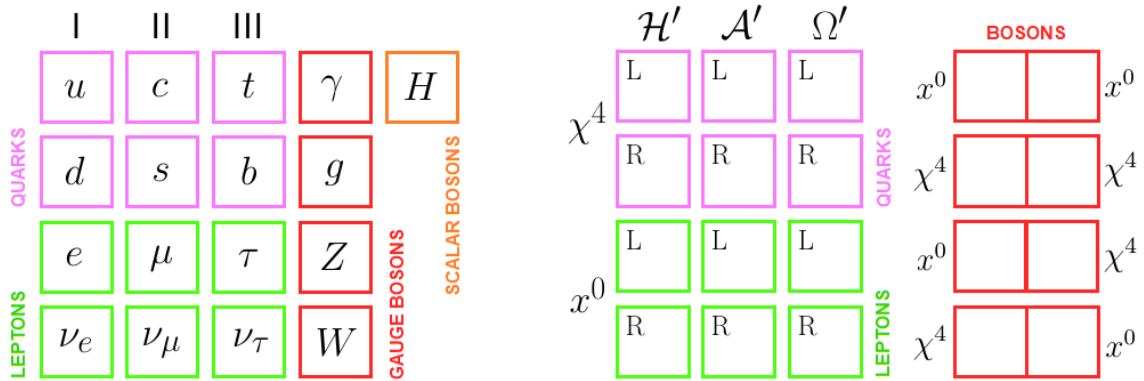

Figure 3: The MCM particle model (right) compared to the standard model of particle physics (left). Each instance of x^0 or χ^4 refers to a spacetime spanned by x^i and either x^0 or χ^4 . The scalar Higgs boson is an outlier in the standard model, but there are no such outliers in the modified model.

sality. The standard model predicts that each lepton flavor should be identical to the others up to its mass, but modern experiments suggest that this is not the case. The proton radius puzzle observed in the muonic hydrogen system [65] is an example of experimentally determined non-universality among lepton flavors. By putting each of the MCM matter particle generations into a different state space, we motivate lepton non-universality in principle, as required for agreement with experiment.

We have relied to some degree on phenomenological considerations when constructing the MCM model of particles. Still, the model suffices to claim a first principles derivation of the particle spectrum. The unit cell has permutations of its objects generating two pairs of particles in three varieties, and one of those pairs may be distinguished by three further varieties of QCD color charge with $\{+, -, \emptyset\}$. The fundamental bosons are well accommodated too. It is known that the 12 fundamental matter particles are spin-1/2 fermions, so we assign that property to each MCM quantum of spacetime by supposition. Spin-1/2 is well aligned with χ_\pm^4 spanning only one of Σ^+ or Σ^- , but never both. Similarly, the scale of any MCM spacetime quantum will be half the width of the unit cell. The force carrying particles of the standard model are known to have spin-1, so the MCM bosons are assembled from pairs of matter particles. This is done in part because $\frac{1}{2} + \frac{1}{2} = 1$, and in part because forces are usually transmitted between pairs of fermionic matter particles.

Being the most ordinary and well-understood force carrying particle, the photon is the x^0x^0 particle at the top of Figure 3's stack of elementary MCM bosons. The most complicated, least understood elementary boson is the gluon g associated with the

$\chi^4\chi^4$ connection. In this arrangement, we find more support for the MCM particle scheme. It is known from experiment that there exist eight varieties of gluon. A triumph of the MCM is that we obtain eight such varieties in the unit cell. Quark flavor is associated with the three varieties of χ^4 . Gluons are associated with connections between quarks. The nine permutations of a $\chi^4\chi^4$ connection are $++$, $+\emptyset$, $+-$, $\emptyset+$, $\emptyset\emptyset$, $\emptyset-$, $-+$, $-\emptyset$, and $--$. Removing $\emptyset\emptyset$ on some qualitative grounds (which may be inferred from the \emptyset symbol itself), we are left with eight varieties of gluon.

Why should $\emptyset\emptyset$ not be associated with a gluon? There are many possible reasons, but it is hoped that the reason will fall out from future inquiry. Since χ_{\emptyset}^4 has no length in the convention where Ω is joined to \mathcal{A} by a single point, the $\emptyset\emptyset$ gluon has no moment, in some sense. The other eight connections do have non-vanishing moments, in that sense. Another reason might be that the other eight gluons connect to \mathcal{H} through Σ^{\pm} while $\emptyset\emptyset$ does not. For that reason, it may not be observable, or may not be directly observable. As we will detail in Section 1, all observations are necessarily made in \mathcal{H} , so the property of being observable may depend on connection to \mathcal{H} . Another possibility is that there are, indeed, nine gluons, and that a nine gluon model would improve the theory of QCD. One might take the $\emptyset\emptyset$ connection as a sterile gluon in the manner that sterile neutrinos are sometimes thought to exist. In general, the total picture of QCD physics is complicated and has a lot of room for improvement.

Ignoring a hypothetical Higgs boson, the only remaining standard model particles requiring placement in the modified model are the W and Z bosons. These are accommodated by either of the two remaining connections: $x^0\chi^4$ or χ^4x^0 . Choosing the former, the original assignment in [6] cast W^{\pm} as $x^0\chi_{\pm}^4$ and Z^0 as $x^0\chi_{\emptyset}^4$ [6]. The weak force governs interactions between leptons and particles made of quarks so, therefore, the admixture of the x^0 and χ^4 elementary fermions in the $x^0\chi^4$ weak boson connection is philosophically robust and physically sound. It is emphasized that the unit cell's permutations' *multiple exact likenesses* to experimentally determined particle properties are evidence that the MCM is a good theory.

We have randomly chosen the $x^0\chi^4$ connection for W and Z . We might have chosen χ^4x^0 . In either case, the MCM predicts at least one more spin-1 elementary particle, possibly three of them, in the remaining partner to $x^0\chi^4$ or χ^4x^0 , as in Figure 3. However, there exists another theoretical variant of the MCM particle scheme which was not mentioned in its first iteration [6]. We have associated the W^{\pm} particle/anti-particle pair with χ_{\pm}^4 , while we have not placed anti-gluons in the $\chi^4\chi^4$ connection. If the \pm scripting does not specify the anti-particle for gluons, then neither should it

for W . Therefore, we might (should) associate the Z and W particles with only two of $\{x^0\chi_+^4, x^0\chi_-^4, x^0\chi_\emptyset^4\}$. In that case, we would suppose that the Higgslike particle is the third member of the $x^0\chi^4$ connection, that $x^0\chi^4$ and χ^4x^0 are indistinguishable, and that the Higgslike spin-1 particle completes the smorgasbord.

Whatever the exact details are, the modified model predicts that there should be no spin-0 fundamental particles. Therefore, the Higgslike particle must have spin-1. If the Higgslike particle is eventually determined to have spin-1, that will be strong evidence that time and effort should be invested in the theses given in the remainder of this book.

Part I: The Modified Cosmological Model

1 The \hat{M}^3 Operator and its Equation

While it is standard in physics communications to put main results at the beginning and then explain them, this will not be possible for \hat{M}^3 . Without developing the context first, the main results could not be conveyed well. Therefore, Sections 1.2 through 1.7 will mostly lay the foundation for more interesting results in Sections 1.8 through 1.11.

1.1 Introduction

The fundamental equation of classical mechanics, $\mathbf{F} = \partial_t \mathbf{p} = m \partial_t^2 \mathbf{x}$, is postulated in Newton's laws. The fundamental equation of quantum mechanics, $i\hbar \partial_t \psi = \hat{H} \psi$, is usually implemented as a postulate. In both cases, the differential operators ∂_t and ∂_t^2 (or the ∂_x^2 in \hat{H}) are used in postulated equations. In the MCM, we would like to obtain a new equation for $\hat{M}^3 \propto \partial_t^3$ such that the discrepancies between classical reality and quantum theory are lessened or remedied. Various postulates or hypotheses for the functioning of \hat{M}^3 have appeared in earlier MCM publications, and, indeed, the number of variations approaches the number of papers written about them. In the end, the postulate should be the only expression consistent with the requirements, up to the form of the representation. At that time, putting the correct equation to paper should be effortless. For this reason, previous work in the MCM has more closely attended that which \hat{M}^3 needs to do than the formal statement and study of a postulate like $F = m\ddot{x}$ or $i\hbar \dot{\psi} = \hat{H} \psi$. In this long section, we will examine the \hat{M}^3 operator which has been identified as an appropriate operator for what should be some new equation for a theory of everything.

1.1.1 The \hat{M}^3 Operator

\hat{M}^3 describes the actions of a physicist. Although the extant quantum theory requires a physicist's actions to implement wavefunction collapse upon measurement, the usual approach to quantum mechanics (QM) ignores the rest of what the physicist does. In efforts to better understand quantum theory, epistemological considerations sometimes fixate on an artificial distinction between a quantum state and an ideal measuring apparatus. It is asked how an *ideal* measurement can be made when detectors are necessarily quantum mechanical themselves. Compounding such questions, many experiments such as the double-slit and delayed-choice quantum eraser experiments [66] show that measurement is supremely weird within the existing framework. Thus, the main new idea in the MCM seeks to separate the physicist from his experiment rather than to separate a hypothetical ideal detector from its quantum subject matter. Measurement is made ideal as a psychological process divorced from anything manifestly quantum mechanical. It is hoped that the description of a time-evolving quantum state will be more natural in this framework.

Regarding questions of epistemology that don't impede one's ability to compare experiments to predictions, physics may be differentiated between work in the esoteric fundamentals and work in the more glamorous applications [67]. The latter is less concerned with philosophical problems, but the MCM is a program in the sub-basement of the fundamentals. We ask questions such as the following. Is it a step too far to suppose that there exists a better framework? Perhaps there is one to which the current theory is only an approximation? Is it wrong not to shut up and calculate? To these ends, we have identified \hat{M}^3 as a good operator for what should be a new revolution in the arena of the fundamentals.

The psychological process for \hat{M}^3 was defined as follows [3].

“To test any theory[,] two measurements must be made. Call these measurements A and B corresponding to events a and b . The boundary condition set by A will be used to predict the state at b . To make this prediction[,] the observer applies physical theory to trace a trajectory from A to the future event b . Before the observer can verify the theory, sufficient time must pass that the future event occurs. Once this happens[,] a retarded signal from b reaches the observer in the present[,] and a second measurement B becomes possible. [F]rom the present[,] the observer traces a path into the future. Once that future becomes part of the observer's past, a signal reaches the observer in the present[,] and the theory can be

tested. A three-fold process.

$$\text{Present} \mapsto \text{Future} \mapsto \text{Past} \mapsto \text{Present}^1 \text{ .} \quad (1.1.1)$$

The process of \hat{M}^3 starts at A . Some event a has already occurred. The signal from a has reached the observer who has represented the condition of a as some abstract or analytical expression. For instance, a detector has registered a particle at some point in space, or in some region of spacetime,² and then the detector told the observer what it saw. The observer says, “Given my observation A , I predict by theoretical construction that a subsequent event b will occur, which I will observe at B .” This prediction is the first step of \hat{M}^3 . It is an abstract prediction Present \mapsto Future. The next step requires a time translation of the observer to some time later than the time associated with the predicted event. Since we expect \hat{M}^3 to operate on states rather than the observer, the observer’s time translation might be implemented as a translation of a and/or b to an earlier time. This is the second step Future \mapsto Past. The third step is a reconnection to the psychological level when the signal from b comes to the observer’s attention at B : Past \mapsto Present. It is hoped that a new equation which reflects this process will improve quantum theory and human understanding. Feynman states the idea in [68].

“[T]here is always hope that [a] new point of view will inspire an idea for the modification of present theories, a modification necessary to encompass present experiments.”

1.1.2 Principles and Equations

Einstein’s greatest genius was to conceive of the equivalence principle. Briefly, experiments done in gravity must yield the same results when done in a spaceship under the same acceleration. To formalize this principle mathematically, Einstein had to collaborate for several years with mathematicians such as Grossmann, but Einstein’s true genius was not finding Einstein’s equation. The work of profound genius was to conceive of a new principle which must be satisfied by an equation *in some form*. Finding that equation, while difficult and admirable, was ultimately a labor. Einstein describes himself as working “like a horse” in his quest to find the equation once the principle was set. Similarly, Newton was in correspondence with Leibniz to some degree during the development of calculus, but Newton is regarded as the

¹The \mapsto symbol was chosen only so as to use a generalized arrow symbol for this word-level expression.

²Whether an apparatus detects the particle at a point or merely within some region is an interesting and open question. In the end, all that is known is that the observer cannot glean more information from the apparatus than the region of spacetime in which the particle is detected.

supreme genius due to his conception of the laws of motion. The modern mathematical statement of classical mechanics is mostly due to Cauchy, not Newton, but Newton is regarded as the grandfather of physics because the highest achievement is the formulation of new principles. As the laws of motion must be satisfied, and as the equivalence principle must be satisfied, the MCM process for \hat{M}^3 must be satisfied. The description of the three-fold psychological process for \hat{M}^3 is as irrefutable and self-evident as any other principle in physics. There *must* exist a mathematical language for describing it.

1.1.3 Targeted Issues in Quantum Theory

After introducing notation in Section 1.2 for associating quantum states with the elements of the unit cell, we will present cases that \hat{M}^3 should be useful for the following.

- To implement dynamical rather than ad hoc wavefunction collapse (Section 1.8).
- To explain the origin of the fine structure constant (Section 1.9).
- To promote the metric from a disconnected background in quantum theory to a dynamical object in it via a new theory of quantum gravity (Section 1.10).
- To find use cases in physics for new mathematical tools related to fractional distance analysis (Section 1.6) [2], and to do a few other things.

The usual formulation of quantum theory provides no dynamical mechanism for wavefunction collapse, also called state reduction or projection. With \hat{M}^3 , the MCM adds some extra steps to time evolution that are purposed to accommodate such a mechanism. Presently, collapse is inserted into QM as needed to force agreement with experiment. If dynamical collapse is achieved, quantum theory will be much improved. Isham writes the following regarding this most glaring gap begging for improvement [69].

“[T]he idea of a reduction of the state vector is often invoked in more realist approaches in which the state vector is deemed to refer to a single system. The reduction is then assumed to occur after a *single* (ideal) measurement, and has nothing to do with system selection in a series of repeated measurements. From this perspective, the overall time development of a state of a single system consists of sharp jumps produced by the act of measurement, separated by periods of deterministic evolution governed by the Schrödinger equation[.]”

“The major problem is to understand the origin of these sudden changes in the state. In particular, can they be obtained from the existing quantum formalism, or does the reduction of the state vector have to be added to the general rules of quantum theory as a fundamental postulate? This problem is particularly acute in any approach to quantum theory that aspires to demote ‘measurement’ from playing a fundamental part in the formulation of the theory. In this case, there is a strong motivation to try to derive the state reduction vector from the existing formalism; albeit, perhaps, only as an empirically useful approximation to the actual development of the state in time.

“The nature of the problem depends in part on the perceived referent of the state. If the state is held to quantify our *knowledge* of the system, then the reduction process is arguably analogous to the conditioning procedure in classical probability in which the addition of extra information about what is actually the case changes our state of knowledge. On the other hand, if the state vector is held to refer to the system itself, then the idea of reduction is frequently tied to the ‘uncontrollable disturbance’ thesis. This raises the obvious question of the possibility of understanding the nature of this effect in direct physical terms. In particular, what type of interaction serves as an ‘ideal measurement’?

“One approach to this problem is to ask again about the significance of the fact that actual measuring devices are made of quantum atoms. Is it possible to understand a state reduction as the outcome of some dynamical evolution in which object and apparatus are both regarded as quantum-mechanical systems? Indeed, even within the minimal, pragmatic approach to quantum theory there is good reason for asking what *type* of interaction between two systems is to be regarded as a *bona fide* measurement of one by the other. The concept of measurement plays a fundamental role in the formulation of quantum theory, and therefore deserves to be understood further.”

Measurement is of fundamental importance in the MCM. Each measurement of a quantum system corresponds to an \mathcal{H} -brane. Diffusion under the Schrödinger equation happens in the bulk spaces Σ^\pm , and the sharp jump to the k^{th} collapsed state is associated with \mathcal{H}_k . The act of measurement is made ideal as an interaction between a system made of atoms and an observer’s non-quantum consciousness.

It remains hard to motivate the value for the MCM fine structure constant α_{MCM} ,

so we will not phrase the present problem of \hat{M}^3 in terms of the original motivation [30]. Instead, we will lay out the current best understanding of \hat{M}^3 , and some problems found to deserve further development. Appendix A describes the original program by which the fine structure constant was found, and then the existence of \hat{M}^3 was deduced from the analytical structure of

$$\alpha_{\text{MCM}}^{-1} = 2\pi + (\Phi\pi)^3 \approx \alpha_{\text{QED}}^{-1} . \quad (1.1.2)$$

Regarding our intention to supplement the existing framework of quantum theory with \hat{M}^3 , Finkelstein writes the following [70].

“Quantum theory began with ad hoc regularization prescriptions of Planck and Bohr to fit the weird behavior of the electromagnetic field and the nuclear atom[,] and to handle infinities that blocked earlier theories. In 1924[,] Heisenberg discovered that one small change in algebra did both naturally.”¹

Heisenberg stated the following in his 1933 Nobel address.

“Quantum mechanics [...] arose, in its formal content, from the endeavor to expand Bohr’s principle of correspondence to a complete mathematical scheme by refining his assertions.”

Similarly, it remains to expand the MCM principles to a complete mathematical scheme by refining the assertions about \hat{M}^3 . To wit, we have found a value α_{MCM} that falls out of some (mostly) standard quantum mechanical language, but we have neither connected that language to the full quantum theory nor explained the 0.4% discrepancy with α_{QED} (Section 1.9.4). There exists an idea for how state reduction might be implemented more naturally in the MCM than it is in QM (Section 1.8) [71], but we have not written down any Eureka-level equations of motion. While such deficiencies remain to be remedied in the course of the work described in this book, the new object $\widehat{\infty}$ called algebraic infinity (Section 1.6) is most certainly a Eureka-level idea for handling certain infinities that block *current* theories.

On the problem of quantum gravity, we say it is a hard problem because there does not exist a robust mathematical language in which the objects of the gravitational

¹Heisenberg’s famous $\hat{p}\hat{q}-\hat{q}\hat{p}\neq 0$ quantum algebra was a small change in notation but it reflects a giant leap in the ability of humans to understand the natural world. After all, the idea that 3×2 under certain circumstances might not equal 2×3 was a radical departure from thousands of years of previous mathematical thinking. Heisenberg’s change of algebraic structure is the origin of the phrase “a quantum leap” meaning “a huge or sudden increase or advance of something.”

theory can be put into an equation with the objects of the quantum theory.¹ General relativity (GR) is a theory of points in spacetime, but the state of being located at a point cannot be measured and does not exist in Hilbert space. Quantum states are fuzzy, but GR does not admit fuzziness. Far removed from a theory of gravitons or questions about the curvature of spacetime as a disconnected background to quantum theory, the general problem of quantum gravity is that there does not exist a good framework in which it is possible to put the equivalence relation = between two separate statements of gravitation and quantization. For instance, the equivalence of the inertial mass in classical mechanics and electrodynamics allows us to combine the Lorentz force law with arbitrary mechanical forces. On the other hand, there is no Schrödinger equation for the metric, and there is no way to put a probability amplitude into a stress-energy tensor such that it is mutually dynamical with Schrödinger evolution. The MCM mechanism for quantum gravity (Section 1.10) offers an original and exciting mathematical language in which quantum objects might interact with gravitational objects. However, it very much remains to establish this new language as a complete mathematical framework.

1.2 The Ontological Basis

The process

$$\text{Present} \mapsto \text{Future} \mapsto \text{Past} \mapsto \text{Present} \quad , \quad (1.2.1)$$

is associated with the operator

$$\hat{M}^3 : \mathcal{H}'_1 \rightarrow \Omega'_1 \rightarrow \mathcal{A}'_2 \rightarrow \mathcal{H}'_2 \quad , \quad (1.2.2)$$

and/or its variant

$$\hat{M}^3 : \mathcal{H}_1 \rightarrow \Omega_1 \rightarrow \mathcal{A}_2 \rightarrow \mathcal{H}_2 \quad . \quad (1.2.3)$$

The former describes abstract algebraic translation through rigged Hilbert space. The latter describes geometric translation through coordinate space. \hat{M}^3 itself operates on states, so notation is required to specify where a given state lives: which of the

¹There is some machinery in QFT by which a certain tensor field $\varphi_{\mu\nu}$ (called a graviton field) can couple in its two indices to a stress-energy tensor $T^{\mu\nu}$. The QFT graviton can be used to reproduce a few experimental results, but most of those come only under a host of simplifications, hand-waving, and cumbersome constraints. The QFT graviton is ugly, not beautiful, and it is useful only for small perturbations on Minkowski space. In the opinion of this writer, furthermore, there is little reason to think that the hypothetical quantum force carrier of the gravitational force is real because there is no gravitational force. Gravitation is geometry in curved spacetime. It is a fact that a rank-2 tensor field can couple to $T^{\mu\nu}$ in QFT, but it is not well established that this confluence of tensor indices is well suited to the general problem of quantum gravity. After all, this coupling has been known for decades, and there is no consensus on what a working theory of quantum gravity might look like, or how one might demonstrate gravitons' existence through observation. Indeed, there is no consensus on the existence of gravitons due in part to the weakness of the theoretical framework for $\varphi_{\mu\nu}$ in applications to gravitation.

branes and/or which of the state spaces along the process of \hat{M}^3 . For instance, we will introduce notation such that a state in \mathcal{H}' has the domain of its wavefunction representation specified as the x^i spatial part of the x^μ physical coordinates charting \mathcal{H} . However, if

$$\begin{aligned} \psi \in \mathcal{H}' &\implies \psi = \psi(x^i) \\ \psi \in \mathcal{A}' &\implies \psi = \psi(x_-^i) \\ \psi \in \Omega' &\implies \psi = \psi(x_+^i) \text{ , }^1 \end{aligned} \tag{1.2.4}$$

then the $\mathcal{H}' \subset \mathcal{A}' \subset \Omega'$ nested structure of the RHS $\{\mathcal{H}', \mathcal{A}', \Omega'\}$ is superficially confounded. The space of functions of a given variable is not intuitively a subspace of the space of functions of another variable. Still, it is possible that states represented by the former might span a subspace of the states represented by the latter. To avoid any potential problems, an appeal is made to a subtle difference little considered in physics: the difference between state spaces and function spaces. In this section, we will clarify these details somewhat and introduce **the ontological basis**. It assigns wavefunctions to the various branes in the MCM unit cell and their corresponding state spaces.

Let $\psi_k: \mathbb{R} \rightarrow \mathbb{C}$ be a function, and let \times be an inner product. Then

$$\left. \begin{aligned} \mathcal{H}' &= \{\psi_1, \psi_2; \times\} \\ \mathcal{A}' &= \{\psi_1, \psi_2, \psi_3; \times\} \\ \Omega' &= \{\psi_1, \psi_2, \psi_3, \psi_4; \times\} \end{aligned} \right\} \implies \mathcal{H}' \subset \mathcal{A}' \subset \Omega' \text{ ,} \tag{1.2.5}$$

at least approximates an RHS if it does not satisfy the definition directly. To break the nested structure and support an arrangement of functions of different variables, we will append labels as

$$\left. \begin{aligned} \mathcal{H}'_{\mathbf{H}} &= \{\psi_1, \psi_2; \times, \mathbf{H}\} \\ \mathcal{A}'_{\mathbf{A}} &= \{\psi_1, \psi_2, \psi_3; \times, \mathbf{Alpha}\} \\ \Omega'_{\mathbf{0}} &= \{\psi_1, \psi_2, \psi_3, \psi_4; \times, \mathbf{Omega}\} \end{aligned} \right\} \implies \mathcal{H}'_{\mathbf{H}} \not\subset \mathcal{A}'_{\mathbf{A}} \not\subset \Omega'_{\mathbf{0}} \text{ .} \tag{1.2.6}$$

Now, suppose $\mathcal{D}_{\mathbf{H}}$, $\mathcal{D}_{\mathbf{A}}$, and $\mathcal{D}_{\mathbf{0}}$ are three non-intersecting subsets of \mathbb{R} such that

$$\psi \in \mathcal{H}'_{\mathbf{H}} \implies \psi: \mathcal{D}_{\mathbf{H}} \rightarrow \mathbb{C}$$

¹Recall that x_{\pm}^{μ} are the physical coordinates on slices of Σ^{\pm} at constant χ_{\pm}^4 , as in Section 0.2.

$$\begin{aligned}
 \psi \in \mathcal{A}'_{\mathbf{A}} &\implies \psi : \mathcal{D}_{\mathbf{A}} \rightarrow \mathbb{C} & (1.2.7) \\
 \psi \in \Omega'_0 &\implies \psi : \mathcal{D}_0 \rightarrow \mathbb{C} \ .
 \end{aligned}$$

A function is usually defined as a binary relation between two sets, so it follows, for instance, that $\psi(x) = \sin(x)$ is the same function regardless of which \mathcal{D} is its domain. However, if

$$\begin{aligned}
 \mathcal{H}'_{\mathbf{H}} \ni \psi_{\mathbf{H}} &: [0, 2\pi] \rightarrow [-1, 1] \\
 \mathcal{A}'_{\mathbf{A}} \ni \psi_{\mathbf{A}} &: [4\pi, 6\pi] \rightarrow [-1, 1] & (1.2.8) \\
 \Omega'_0 \ni \psi_0 &: [8\pi, 10\pi] \rightarrow [-1, 1] \ ,
 \end{aligned}$$

then the different ψ_k are not exactly the same. This invokes a nuanced technical issue which we will revisit in Section 31 pertaining to a criticism of Scholze and Styx against Mochizuki's inter-universal Teichmüller theory (IUT).¹ The definition of a function as a binary relation between two sets makes it easy to ignore the subtle distinction between a state space containing abstract $|\psi\rangle$ vectors and function spaces containing the $\psi(x)$ wavefunction representations. It is normal in physics to write $|\psi\rangle = \psi(x)$, meaning that the state is identically the wavefunction, but, formally, it is not. To be very specific, or rigorous, one must ask if the definition of the function includes the identity of the two sets related by it. Regarding the matter of \hat{M}^3 , it is not relevant whether the identity of a function depends on the identity of its domain. The nested structure of $\{\mathcal{H}', \mathcal{A}', \Omega'\}$ is such that $\psi \in \mathcal{H}'$ implies $\psi \in \mathcal{A}'$ and $\psi \in \Omega'$, and we will do physics in the way that ignores unnecessary mathematical nuance. We will drop the subscripts and call $\{\mathcal{H}', \mathcal{A}', \Omega'\}$ an RHS even though we have added an implicit labeling scheme such that the nested structure is broken by (1.2.4), in some sense.

MCM state spaces must have an associated manifold specified so we may know which coordinates chart the domains of the states' wavefunction representations. For this purpose, we have introduced the ontological basis $\{\hat{e}_{\mathcal{H}}, \hat{e}_{\mathcal{A}}, \hat{e}_{\Omega}\}$ such that

$$\begin{aligned}
 \psi \in \mathcal{H}' &\iff |\psi\rangle = |\psi\rangle\hat{e}_{\mathcal{H}} = |\psi; \hat{e}_{\mathcal{H}}\rangle = \psi(x^i) \\
 \psi \in \mathcal{A}' &\iff |\psi\rangle = |\psi\rangle\hat{e}_{\mathcal{A}} = |\psi; \hat{e}_{\mathcal{A}}\rangle = \psi(x^i_-) & (1.2.9) \\
 \psi \in \Omega' &\iff |\psi\rangle = |\psi\rangle\hat{e}_{\Omega} = |\psi; \hat{e}_{\Omega}\rangle = \psi(x^i_+) \ .
 \end{aligned}$$

We also suppose the existence of a fourth basis element \hat{e}_{\emptyset} such that $|\psi\rangle\hat{e}_{\emptyset} = \psi(x^i_{\emptyset})$

¹We will suggest that Mochizuki's Hodge theater is a rebranded MCM unit cell, and that his later work on IUT is an attempted completion of the \hat{M}^3 theory.

or $|\psi\rangle\hat{e}_\emptyset = \psi(\chi_\emptyset^a)$. (Refer to Figure 1 for placement of \emptyset in the unit cell.) Now that we have developed the requisite objects, we may supplement the abstract notation of (1.2.2) and (1.2.3) with an ordinary operator algebra. Letting $\hat{M}^3 \equiv \hat{M}_3\hat{M}_2\hat{M}_1$, we have

$$\left. \begin{aligned} \hat{M}_1|\psi; \hat{e}_{\mathcal{H}_1}\rangle &= c_1|\psi; \hat{e}_{\Omega_1}\rangle \\ \hat{M}_2|\psi; \hat{e}_{\Omega_1}\rangle &= c_2|\psi; \hat{e}_{\mathcal{A}_2}\rangle \\ \hat{M}_3|\psi; \hat{e}_{\mathcal{A}_2}\rangle &= c_3|\psi; \hat{e}_{\mathcal{H}_2}\rangle \end{aligned} \right\} \implies \hat{M}^3|\psi; \hat{e}_{\mathcal{H}_1}\rangle = c_3c_2c_1|\psi; \hat{e}_{\mathcal{H}_2}\rangle \quad . \quad (1.2.10)$$

\hat{M}^3 executes $\mathcal{H}_1 \rightarrow \mathcal{H}_2$ via the given intermediate steps. It operates on states in one unit cell and returns states in a time-advanced unit cell. Schrödinger evolution also occurs between \mathcal{H}_1 and \mathcal{H}_2 , and the intermediate steps of \hat{M}^3 are specified to add complexity to the usual theory in which the Schrödinger equation is integrated from t_1 to t_2 . Assigning $t_1 \in \mathcal{H}_1$ and $t_2 \in \mathcal{H}_2$,¹ the intermediate steps provide a framework in which more can happen than what QM describes as monotonic diffusion followed by instantaneous collapse. The structure provided by the intermediate steps is pointed out so as to avoid an appearance of redundancy in what might otherwise be written as $\hat{M}^3 : \mathcal{H}_1 \rightarrow \mathcal{H}_2$ without a reference to the intermediate steps that should be useful for applications towards modified Schrödinger evolution. Further inquiry is required to determine an analytical statement of this new theoretical structure.

In practice, the MCM cosmological lattice is infinite in extent. Each unit cell resides at a later chronological time than all leftward unit cells, and at a later chirological time. Each successive unit cell is said to be on a higher *level of aleph* (Section 1.6) [2, 49] than the unit cells at earlier chirological times. Levels of aleph are an abstract characteristic introduced to differentiate one unit cell from its neighbors. The subscripts on the $\{\hat{e}_\mu\}$ in (1.2.10), e.g.: \hat{e}_{Ω_1} and $\hat{e}_{\mathcal{A}_2}$, refer to branes on the first and second levels of aleph. (See Figure 1 for similar labeling on Σ^\pm .) Levels of aleph are labeled with integers, so any \mathcal{H}_k will have an infinite number of earlier and later $\{\mathcal{H}_j\}$.

In practice, it may be useful to consider cyclic $\hat{M}^3 : \mathcal{H} \rightarrow \Omega \rightarrow \mathcal{A} \rightarrow \mathcal{H}$ in place of the non-cyclic $\hat{M}^3 : \mathcal{H}_1 \rightarrow \Omega_1 \rightarrow \mathcal{A}_2 \rightarrow \mathcal{H}_2$. In other words, we might drop the subscripts to treat the problem as a small algebraic group.

¹This notation means that the measurement associated with \mathcal{H}_1 happened at $x^0 = t_1$, t_1 was the observer's proper time in \mathcal{H}_1 , and the same for t_2 and \mathcal{H}_2 .

1.2.1 A Program in Number Theory

\hat{M}^3 is formulated to describe the process by which a theory is tested with experiment. The operation is *psychological* because the chronological time interval between two unit cells depends on how long the observer waits to test his prediction. A requirement for regular periodicity in the overall lattice of all unit cells, or for the *self-similarity* of all unit cells, is fulfilled through a regularized chirological time interval between \mathcal{H}_1 and \mathcal{H}_2 . The interval in the abstract coordinates will be proportional to the golden ratio Φ without regard for the duration of chronological time between successive measurements. We will say more about the golden ratio and our reasons for using it in Section 1.2.4 (see also [71, 72]).

The defining property of a set of basis vectors is the linear independence of the basis' elements. Usually, the elements are unit vectors. The particular basis $\{\hat{e}_{\mathcal{H}}, \hat{e}_{\mathcal{A}}, \hat{e}_{\Omega}, \hat{e}_{\emptyset}\}$ is called “ontological” due to the specification of certain non-unit magnitudes for its elements. By choosing the number-theoretically significant magnitudes $\{2, \pi, i, \Phi\}$ in some order for $\{\|\hat{e}_{\mathcal{H}}\|, \|\hat{e}_{\Omega}\|, \|\hat{e}_{\mathcal{A}}\|, \|\hat{e}_{\emptyset}\|\}$, we hope to generate certain properties of the natural world by these numbers' association with the structure of the unit cell. The present convention is

$$\begin{array}{cccc}
 \hat{e}_{\mathcal{H}} = \hat{\pi} & \hat{e}_{\Omega} = \hat{\Phi} & \hat{e}_{\mathcal{A}} = \hat{2} & \hat{e}_{\emptyset} = \hat{i} \\
 |\hat{\pi}| = \pi & |\hat{\Phi}| = \Phi & |\hat{2}| = 2 & |\hat{i}| = 1 \\
 \|\hat{\pi}\| = \pi & \|\hat{\Phi}\| = \Phi & \|\hat{2}\| = 2 & \|\hat{i}\| = i \quad .^1
 \end{array} \tag{1.2.11}$$

Using a further convention such that the observer's reference frame at measurement A is normalized to the zeroth level of aleph, \hat{M}^3 will operate as

$$\left. \begin{array}{l}
 \hat{M}_1|\psi; \hat{\pi}^0\rangle = \pi|\psi; \hat{\Phi}^0\rangle \\
 \hat{M}_2|\psi; \hat{\Phi}^0\rangle = \Phi|\psi; \hat{2}^1\rangle \\
 \hat{M}_3|\psi; \hat{2}^1\rangle = 2|\psi; \hat{\pi}^1\rangle
 \end{array} \right\} \implies \hat{M}^3|\psi; \hat{\pi}^0\rangle = 2\pi\Phi|\psi; \hat{\pi}^1\rangle . \tag{1.2.12}$$

\hat{M}^3 takes a state in one unit cell, or on one level of aleph, and puts it into the next one. This operator algebra is presented as an ansatz pending development of analytical representations for \hat{M}^3 and $|\psi; \hat{e}_{\mu}^k\rangle$. The former iterator subscript of (1.2.10) has been refashioned as an algebraically meaningful integer exponent k . $\hat{\pi}^0 = \hat{1}$ allows us to use

¹In the previous conventions for the ontological basis vectors [1, 3, 30], \mathcal{A} and \emptyset were oppositely labeled with \hat{i} and $\hat{2}$. The present convention is better suited to the MCM formula for the fine structure constant (Section 1.9).

ordinary QM states as MCM states in \mathcal{H}_0 .¹ For now, we will assume the $2\pi\Phi$ scalar coefficient² and proceed to examine the ontological basis.

To detail the basis' functioning, we will use the example

$$\mathbf{x} = x\hat{e}_x \quad . \quad (1.2.13)$$

It is understood that we may ignore the unit vector in the x direction to use notation such that \mathbf{x} is a vector with magnitude x in the implicit direction. Similarly, we will recover ordinary QM state vectors in \mathcal{H} by ignoring $\hat{\pi}$:

$$|\psi; \hat{\pi}\rangle = |\psi\rangle\hat{\pi} = \psi(x^i) \quad . \quad (1.2.14)$$

If the normalization convention includes the magnitude of $\hat{\pi}$, i.e.:

$$\langle\psi; \hat{\pi}|\psi; \hat{\pi}\rangle = |\hat{\pi}|\langle\psi|\psi\rangle|\hat{\pi}| = 1 \quad , \quad (1.2.15)$$

then the convention of (1.2.14) induces a notion of relative scale between branes. For instance, (1.2.14) would be written

$$|\psi; \hat{\pi}^0\rangle = |\psi\rangle\hat{\pi}^0 = \psi(x^i)|\hat{\pi}^0| \quad , \quad (1.2.16)$$

while ignoring a non-unit basis vector will alter a state's magnitude:

$$|\psi; \hat{\pi}^1\rangle = |\psi\rangle\hat{\pi}^1 = \frac{1}{\pi}\psi(x^i)|\hat{\pi}^1| \quad , \quad \text{and} \quad |\psi; \hat{\pi}^k\rangle = |\psi\rangle\hat{\pi}^k = \frac{1}{\pi^k}\psi(x^i)|\hat{\pi}^k| \quad . \quad (1.2.17)$$

This concept of relative scale will be used extensively in later sections.

A further property of the hat notation is demonstrated with the redundant expression

$$\mathbf{a} = a\hat{e}_x|\hat{e}_y||\hat{e}_z| \quad , \quad \text{where} \quad |\hat{e}_i| = 1 \quad . \quad (1.2.18)$$

If one wants to know what \mathbf{a} looks like when it points in in the y direction, call it \mathbf{a}' , one must rearrange the absolute value bars. For some operator $\hat{O}_{x\rightarrow y}$, we have

$$\hat{O}_{x\rightarrow y}\mathbf{a} = \hat{O}_{x\rightarrow y}(a\hat{e}_x|\hat{e}_y||\hat{e}_z|) = a|\hat{e}_x|\hat{e}_y|\hat{e}_z| = \mathbf{a}' \quad . \quad (1.2.19)$$

¹ $\hat{\pi}^0 = \hat{1}$ may suggest that $\hat{\Phi}^0 = \hat{1}$ as well. To avoid any possible association of $\hat{\Phi}^0$ with the identity operator, future inquiry might study the case where the Ω -brane following \mathcal{H}_0 is already on the higher level of aleph. The current labeling scheme is such that \mathcal{H} and its adjacent \mathcal{A} - and Ω -branes are on the same level of aleph. The level is said to increase at \emptyset , as in Figure 1. However, an alternative convention in which the level of aleph increases at \mathcal{H} must be considered as well. In that convention, all chirologically future-directed branes beyond \mathcal{H}_0 would be labeled by $k > 1$ on ontological basis vectors with non-unit magnitudes.

²This scalar differs from the $i\pi\Phi$ and $i\pi\Phi^2$ constants which have appeared in previous work due mainly to the reassignments of \hat{i} and $\hat{2}$.

Usually, $\hat{O}_{x \rightarrow y}$ would be a $\pi/2$ rotation operation about the z -axis, but here we wish to emphasize an algebraic picture over a geometric one. In the desired algebraic picture, we have an implicit similitude to the three steps in (1.2.12):

$$\hat{M}_1 \sim \hat{O}_{\mathcal{H} \rightarrow \Omega} \quad , \quad \hat{M}_2 \sim \hat{O}_{\Omega \rightarrow \mathcal{A}} \quad , \quad \text{and} \quad \hat{M}_3 \sim \hat{O}_{\mathcal{A} \rightarrow \mathcal{H}} \quad . \quad (1.2.20)$$

The laws of linear algebra suggest that we may execute any $\hat{O}_{\mu \rightarrow \nu}$ simply by moving the hat around. The matter is slightly complicated in the unit cell by the non-unit magnitudes of the ontological basis vectors, but the procedure will follow (1.2.19). To preserve the unit magnitude of the identity in the following, we will replace the $|\hat{e}_i|$ of (1.2.19) with $\|\hat{e}_\mu\|/\|\hat{e}_\mu\|$. Considering $|\hat{i}|=1$ and $\|\hat{i}\|=i$, the norm rather than the absolute value is used to write, for example,

$$\begin{aligned} \hat{O}_{\mathcal{H} \rightarrow \mathcal{A}}|\psi; \hat{\pi}\rangle &= \hat{O}_{\mathcal{H} \rightarrow \mathcal{A}}|\psi\rangle \hat{\pi} \frac{\|\hat{2}\| \|\hat{\Phi}\| \|\hat{i}\|}{\|\hat{2}\| \|\hat{\Phi}\| \|\hat{i}\|} \\ &= |\psi\rangle \|\hat{\pi}\| \frac{\hat{2} \|\hat{\Phi}\| \|\hat{i}\|}{\|\hat{2}\| \|\hat{\Phi}\| \|\hat{i}\|} \\ &= \frac{\pi}{2} |\psi; \hat{2}\rangle \quad . \end{aligned} \quad (1.2.21)$$

More concisely, one inserts the relevant identity and moves the hat:

$$\begin{aligned} \hat{O}_{\mathcal{H} \rightarrow \mathcal{A}}|\psi; \hat{\pi}\rangle &= \hat{O}_{\mathcal{H} \rightarrow \mathcal{A}}(\mathbb{1}|\psi\rangle \hat{\pi}) \\ &= \hat{O}_{\mathcal{H} \rightarrow \mathcal{A}}\left(\frac{2}{2}|\psi\rangle \hat{\pi}\right) \\ &= \frac{\pi}{2} |\psi; \hat{2}\rangle \quad . \end{aligned} \quad (1.2.22)$$

This protocol for moving hats will be integral to the MCM prescription for quantum gravity in Section 1.10.1.

1.2.2 An Example in Atomic Physics

The commonality of 2, π , and i in quantum theory's analytical expressions motivates their placement in the ontological basis. For example, the wavefunction of a hydrogenic electron ψ_{nlm} is such that

$$\psi_{100} = \frac{1}{\sqrt{4\pi}} \frac{2}{a_0^{3/2}} e^{-r/a_0} \quad , \quad \text{and} \quad \psi_{211} = \frac{1}{\sqrt{64\pi}} \frac{1}{a_0^{3/2}} e^{-r/2a_0} \sin(\theta) e^{i\phi} \quad . \quad (1.2.23)$$

The numbers 2, π , and i are analytically integral in such expressions. On the other

hand, the absent number Φ is associated with the χ^4 direction that is absent from the usual framework for QM. An appeal to the arena of QM as the zeroth level of aleph shows that $\Phi^0 = 1$ is already present in ψ_{nlm} , and every other conceivable wavefunction. The MCM seeks to *modify* the usual arena for quantum theory by embedding it in a fifth dimension. States enter the new MCM arena along $\hat{\Phi}$ pointing out of \mathcal{H} in the χ_+^4 direction toward Ω . As Ω will be located at $\chi_+^4 = \Phi$, we may expect that factors of Φ will accrue upon successive applications of \hat{M}^3 . This is already codified into the $2\pi\Phi$ constant given by $\hat{M}^3|\psi; \hat{\pi}^0\rangle = 2\pi\Phi|\psi; \hat{\pi}^1\rangle$. Such factors of Φ^k will be as integral to the analytical representations of wavefunctions in non- \mathcal{H}_0 branes as are 2, π , and i in \mathcal{H}_0 .¹

In the convention such that $|\psi; \hat{\pi}\rangle = |\psi\rangle\hat{\pi} = \psi(x^i)$, we have hydrogenic states

$$|n, l, m; \hat{\pi}\rangle = |n, l, m\rangle\hat{\pi} = \psi_{nlm}(r, \theta, \phi) \quad , \quad (1.2.24)$$

where $\{r, \theta, \phi\}$ are the spherical polar representation of $x^i \in \mathcal{H}$. Using ψ_{100} as an example, \hat{M}^3 operates as

$$\hat{M}^3|1, 0, 0; \hat{\pi}^0\rangle = 2\pi\Phi|1, 0, 0; \hat{\pi}^1\rangle = \sqrt{4\pi} \frac{\Phi}{a_0^{3/2}} e^{-r/a_0} \quad . \quad (1.2.25)$$

ψ_{nlm} is not time-dependent, so the wavefunction must be the same across any number of successive measurements. As a result, (1.2.25) is mathematically trivial. On the other hand, the theory of quantum states in Hilbert space is such that any two states which differ by a constant are the same. Therefore, (1.2.25) satisfies an important physical constraint: the stationary state remains stationary.

Regarding time-dependent states, it is expected that the ∂_0 and/or ∂_4 time derivatives are the generators of \hat{M}^3 , and the case of \hat{M}^3 acting on time-dependent states must be more complicated than the example of ψ_{nlm} in which all such time derivatives vanish. In general, the structure of the unit cell is such that measurement B in \mathcal{H}_1 occurs at a later chronological time than measurement A in \mathcal{H}_0 . Consequently, it is required that we start with $|\psi, t_0, \hat{\pi}^0\rangle$ and end with $|\psi, t_1, \hat{\pi}^1\rangle$ for some $t_1 > t_0$. At minimum, \hat{M}^3 must be complemented with Schrödinger evolution. More likely, \hat{M}^3 has its own unique time evolution equation which contains the Schrödinger equation as the limit of vanishing chirological derivatives.

¹Later, we will suggest that the exponent on $\hat{\Phi}$ should describe differences in the level of aleph so $\hat{\Phi}^{\Delta^k}$ should vanish for physics confined to \mathcal{H}_0 .

1.2.3 The Proton Radius in Muonic Hydrogen

An unsolved anomaly in modern physics is that the proton radius measured in muonic hydrogen is different than the proton radius measured in electronic hydrogen [65]. Such a result might be explained in principle as a corollary of (1.2.25) because MCM muons live in a different state space than MCM electrons (Section 0.3). In the way that one obtains an arbitrary momentum state by applying a boost to a $k=0$ state, one would obtain a muon state from an electron by applying some $\hat{O}_{\hat{e}_\mu \rightarrow \hat{e}_\nu}$ in the sense of (1.2.19). This operation would have its own non-unit magnitude, scalar constant associated with it because $2\pi\Phi$ is uniquely associated with $\hat{M}^3 \sim \hat{O}_{\mathcal{H}_k \rightarrow \mathcal{H}_{k+1}}$. By some more complicated mechanism, that constant might manifest as an observably different proton radius in the muon-nucleon bound state. Given the normalization convention in (1.2.15) and a proton radius operator \hat{r}_p , one would obtain various matrix elements

$$(\hat{r}_p)_{\mu\nu} = \langle \psi; \hat{e}_\mu | \hat{r}_p | \psi; \hat{e}_\nu \rangle \quad , \quad (1.2.26)$$

for ψ in various branes. For $\mu = \nu$, these matrix elements reduce to the expectation value $\langle \hat{r}_p \rangle$.

1.2.4 The $\hat{\varphi}$ Object and \mathbb{C}^*

The piecewise assembly of the unit cell in Figure 4a makes χ_\pm^4 appear to be linearly dependent. However, these are two linearly independent degrees of freedom. We will take $\hat{\varphi}$ to point in the χ_-^4 direction while $\hat{\Phi}$ points in the direction of χ_+^4 . The right angle in Figure 4b depicts a unit cell assembled from subdomains of two orthogonal, unbounded intervals of χ_\pm^4 .

We have proposed a convention in which \mathcal{A} and Ω are located at $\chi_-^4 = -\varphi$ and $\chi_+^4 = \Phi$ relative to \mathcal{H} at $\lim \chi_\pm^4 \rightarrow 0$. Assuming that \mathcal{H} is spanned by one unit of x^0 , the $\Phi \times 1$ and $1 \times \varphi$ dimensions of the $\chi_-^4 x^0$ and $\chi_+^4 x^0$ boxes makes each an identical golden rectangle. By the well-known properties of the golden ratio, $\Phi^k \times \Phi^{k-1}$ is the only aspect ratio that will allow an infinite tiling succession of different-sized unit cells, each in the same proportion.¹ The infinite succession of unit cells is called **the cosmological lattice**. A unit scale such that each unit cell is the same size as the others generates a constant proportion of self-similarity, but the golden ratio uniquely allows a non-unit tiling proportion:

$$\Phi = \frac{b}{a} = \frac{a+b}{b} \quad . \quad (1.2.27)$$

¹Physical conventions for increasing wavenumber along a golden spiral progression of unit cells were developed in [71].

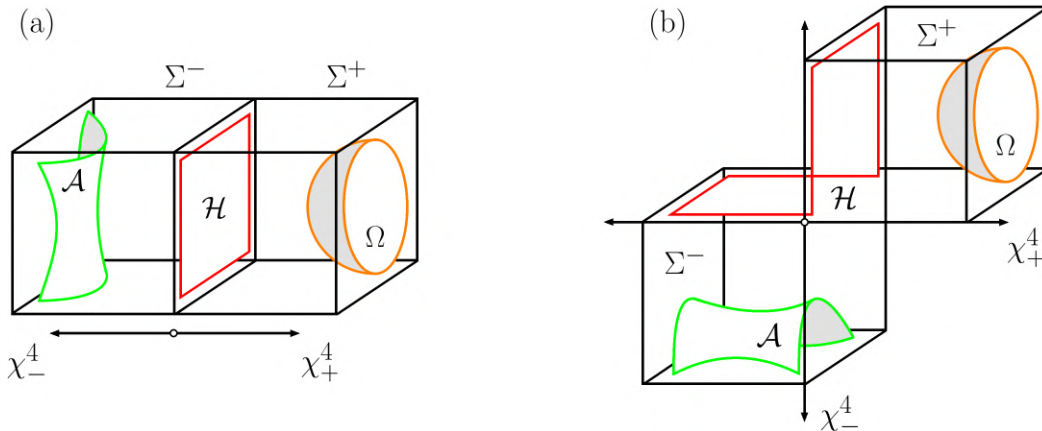

Figure 4: Figure (b) shows an arrangement in which negative-definite $\chi_-^4 \in \Sigma^-$ and positive-definite $\chi_+^4 \in \Sigma^+$ might be assembled from two orthogonal, unbounded intervals of χ_{\pm}^4 . Compared to (a), (b) better emphasizes the linear independence of χ_+^4 and χ_-^4 .

Non-constant scale across successive unit cells is considered desirable for the generation of an arrow of time, and for other results such as the MCM mechanism for dark energy (Section 7). In a unit scaling, we might appeal to the cosmological constant Λ to say that \mathcal{A} has lower energy than Ω , and that, therefore, the chirological arrow of time should point to the left from \mathcal{H} . However, the energy would have to increase again from Σ^- passing into Σ^+ on the round trip back to \mathcal{H} (barring some more nuanced convention for dynamics at \emptyset .) In the present convention, states go into Ω before \mathcal{A} . To support that condition, we will implement a non-unit scale such that \hat{M}^3 preferentially moves states toward the right in the cosmological lattice. Although there does not exist an accepted energy landscape setting the chronological arrow of time, increasing volume in future-directed unit cells may set a chirological arrow of time pointing toward the right due to the thermodynamic tendency of energy densities to decrease. If the forward scale should be smaller, we might invoke gravitational collapse into a singularity at \emptyset to favor a rightward arrow. The main principle is that any scale other than the unit scale can be used to support an arrow of time. Furthermore, non-unit scale will be required to restore normalized probability amplitudes after non-unitary evolution under \hat{M}^3 (Section 1.2.5).¹ By synergy, one would hope to connect these two cases for non-unit scale. As it relates to the present section, $\hat{\Phi}$ points in the direction of increasing scale, and $\hat{\varphi}$ points in the direction of

¹Early steady state models in cosmology supposed a constant generation of new matter-energy to maintain constant density under Hubble expansion [73, 74]. The non-unitary MCM time evolution discussed in Section 1.2.5 may serve a similar purpose.

decreasing scale.

The $\{x^0, x^i, \chi_{\pm}^4\}$ orthogonal coordinate triads are distinguished as right- or left-handed when χ_{\pm}^4 are associated with oppositely directed chirological time by $\hat{\Phi}$ and $\hat{\varphi}$. $\{x^0, x^i, \chi_+^4\}$ is right-handed and $\{x^0, x^i, \chi_-^4\}$ is left-handed. These orthogonal triads are said to span \mathbb{C}_{\pm}^* in Σ^{\pm} respectively. The unit cell is extended from \mathbb{C} in the transverse direction by $\hat{\Phi}$ pointing to the right, and by $\hat{\varphi}$ pointing to the left or down. \mathbb{C} and its transverse continuations are called \mathbb{C}_{\pm}^* . To briefly clarify \mathbb{C}_{\pm}^* without fully formalizing it, and to indicate an avenue for productive future inquiry into distinctness between $\hat{\varphi}$ and $\hat{\Phi}$, the complex plane \mathbb{C} spanned by $\hat{1}$ and \hat{i} is extended in the $\hat{\Phi}$ transverse direction and/or the $\hat{\varphi}$ transverse direction. Using identities $\hat{x} = \hat{x}^i$ and $i\hat{c}\hat{t} = \hat{x}^0$,¹ we may associate \mathcal{H} with \mathbb{C} . Suppressing two spatial dimensions, \hat{x} and \hat{t} point in the $\hat{1}$ and \hat{i} directions respectively. This convention for imaginary t is required to obtain the requisite minus sign in the differential element of flat spacetime interval:²

$$\begin{aligned} ds^2 &= (dx^0)^2 + (dx^1)^2 + (dx^2)^2 + (dx^3)^2 \\ &= -c^2 dt^2 + dx^2 + dy^2 + dz^2 . \end{aligned} \quad (1.2.28)$$

The quadratic relationship $(dx^0)^2 = -c^2 dt^2$ implies a factor of i in the linear relationship. Compared to the convention where the metric is assumed as $g_{\mu\nu} = \text{diag}(-c^2, 1, 1, 1)$ a priori, the convention for $x^0 = ict$ is superior for a number of reasons including its facilitation of the present association between \mathcal{H} and \mathbb{C} .

The extended complex conjugation algebra for \mathbb{C}_{\pm}^* is

$$\left. \begin{array}{l} \hat{\varphi}^* = \hat{\Phi} \\ \hat{\Phi}^* = -i\hat{\varphi} \end{array} \right\} \implies (\hat{\varphi}^*)^* = -i\hat{\varphi} \neq \hat{\varphi} .^3 \quad (1.2.29)$$

This is intended to introduce a quality of irreversibility into progression across the unit cell [30]. Referring to Figure 4a, the basis vectors pointing to the left and right of \mathcal{H} are not merely sign conjugates as are $\{\hat{1}, -\hat{1}\}$ and $\{\hat{i}, -\hat{i}\}$ pointing in the directions that span \mathcal{H} . Due to this assumed conjugation algebra, \hat{M}^3 and $(\hat{M}^3)^\dagger$ are not expected to raise and lower the level of aleph as the Dirac ladder operators \hat{a} and \hat{a}^\dagger raise and lower the principal quantum number for simple harmonic oscillator states. Figure 4b makes it easy to envision $(\hat{M}^3)^\dagger$ as sending a state in \mathcal{H} into an

¹This notation for imaginary t relative to real x^0 may be found in Appendix A3–2 of [75], for example.

²The relationship between negative metric signature and imaginary dimension, or imaginary dimensional transposing parameter, is treated again in Section 10.

³ Φ is a real number, so the meaning of the $*$ operator in \mathbb{C}^* must not be confused with its context in \mathbb{C} where Φ^* is equal to Φ .

upward instance of Σ^- other than the downward one from which it came.

At first glance, χ_-^4 must be imaginary relative to real χ_+^4 because χ_\pm^4 are oppositely timelike and spacelike in the KK metric. For $A_\pm^\mu = 0$, we have

$$g_{AB}^\pm = \begin{pmatrix} g_{\alpha\beta}^\pm & 0 \\ 0 & \chi_\pm^4 \end{pmatrix} = \begin{pmatrix} -c^2 & 0 & 0 & 0 & 0 \\ 0 & 1 & 0 & 0 & 0 \\ 0 & 0 & 1 & 0 & 0 \\ 0 & 0 & 0 & 1 & 0 \\ 0 & 0 & 0 & 0 & \pm|\chi_\pm^4| \end{pmatrix}, \quad (1.2.30)$$

where $\chi_-^4 = -|\chi_-^4|$ because χ_-^4 is negative-definite in Σ^- . This metric implies

$$ds_+ \propto \sqrt{\chi_+^4} d\chi_+^4, \quad \text{and} \quad ds_- \propto i\sqrt{|\chi_-^4|} d\chi_-^4. \quad (1.2.31)$$

The minus sign on g_{00}^\pm requires that distance in the x^0 direction is imaginary (timelike) relative to real spatial distance in the x^i directions. Likewise, the minus sign on g_{44}^- requires that χ_-^4 is imaginary relative to χ_+^4 . To preserve the timelike character of χ_+^4 , we might alternate the phase convention in successive unit cells or associate spacelike χ_+^4 with imaginary time (such as that linking QFT to statistical mechanics.) Overall, the changing metric signature between Σ^\pm represents a hard problem in the issue of the forward connection of Σ^+ to Σ^- , but the issue is well contextualized in the assignment of the \hat{i} ontological basis vector to \emptyset . An extra factor of i may be what is needed to resolve the topological mismatch between the number of spacelike and timelike dimensions in Σ^\pm . Furthermore, Figure 4 suggests that we might define $i\chi_\pm^4$ as two mutually orthogonal directions pointing out of the page such that \hat{M}^3 weaves a path along $\chi_\pm^4 \in \mathbb{C}$ choosing phase as needed so that no metric signature discrepancies are present. To accomplish this, we would rely on the free sign in the Lorentzian metric signature $\{\mp \pm \pm \pm\}$ to alternately assign a factor of i to the real and imaginary parts of χ_\pm^4 in successive unit cells. In some sense, we might use the $i = e^{i\pi/2}$ identity to associate the \hat{i} ontological specifier for \emptyset with a $\pi/2$ rotation away from the direction of metric discrepancy.

In Section 1.7.3, we will associate the region of metric discrepancy with an energetically forbidden region in which the potential energy is higher than the total energy. If the metric discrepancy is associated with real $\chi_+^4 \in \Sigma^+$ followed by imaginary $\chi_-^4 \in \Sigma^-$,

¹Rather than the $\phi_\pm^2 = \chi_\pm^4$ convention shown in (1.2.30), if we require that an alternative convention for $\phi_\pm = \chi_\pm^4$ should preserve the $\{- + + + -\}$ signature in Σ^- , which is required if g_{44}^- is the negative Ricci scalar of AdS₄, then we obtain the complex phase in (1.2.31) more naturally without the square roots.

then the energy landscape will be such that plane waves are preferentially steered onto the real branch of $\chi_-^4 \in \mathbb{C}$, thus avoiding the metric discrepancy.

Finally, we have presented $\hat{\Phi}$ as an ontological basis vector and as a geometric basis vector pointing in the direction of χ_+^4 . We will go on to develop a picture of the ontological basis vectors $\{\hat{2}, \hat{\pi}, \hat{i}, \hat{\Phi}\}$ as lattice vectors anchored in each labeled brane. These vectors will span an ontological lattice in the usual sense of crystallography.

1.2.5 The Non-Unitary Property of \hat{M}^3

In quantum mechanics, an operator \hat{U} is unitary if $\hat{U}^\dagger \hat{U} = \mathbb{1}$. It is unitary if the inverse is the conjugate transpose, also called the Hermitian conjugate or the adjoint. For a time-independent Hamiltonian, the unitary time evolution operator which satisfies Schrödinger's equation is

$$\hat{U}(t_1, t_0) = \exp\left\{\frac{-i\hat{H}(t_1 - t_0)}{\hbar}\right\} \quad , \quad \text{such that} \quad \hat{U}(t_1, t_0)|\psi, t_0\rangle = |\psi, t_1\rangle \quad . \quad (1.2.32)$$

The main application of the unitary property in quantum physics is that the probability interpretation of the wavefunction is preserved by unitary operations. Given

$$\langle \psi, t_0 | \psi, t_0 \rangle = \int_{-\infty}^{\infty} dx \psi^*(x, t_0) \psi(x, t_0) = 1 \quad , \quad (1.2.33)$$

meaning that the probability of observing ψ somewhere in the universe is 100% at time t_0 , the unitary evolution operator is such that

$$\langle \psi, t_0 | \hat{U}^\dagger(t_1, t_0) \hat{U}(t_1, t_0) | \psi, t_0 \rangle = \langle \psi, t_1 | \psi, t_1 \rangle = 1 \quad . \quad (1.2.34)$$

After undergoing unitary evolution to an arbitrary time t_1 , the probability of finding ψ somewhere in the universe is still 100%. The probability obtained in (1.2.33) was multiplied by a factor of *unity* in (1.2.34).

It was emphasized in the development of the MCM that \hat{M}^3 is *not* a unitary operator. The inverse of \hat{M}^3 is not its conjugate transpose, and it should not preserve the probability interpretation without supplemental considerations. If the inverse of \hat{M}^3 exists,

$$(\hat{M}^3)^{-1} \hat{M}^3 = \hat{M}^3 (\hat{M}^3)^{-1} = \mathbb{1} \quad \implies \quad (\hat{M}^3)^{-1} |\psi; \hat{\pi}^k\rangle = \frac{1}{2\pi\Phi} |\psi; \hat{\pi}^{k-1}\rangle \quad . \quad (1.2.35)$$

The rules of matrix algebra are such that

$$\left(\hat{M}^3|\psi; \hat{\pi}\rangle\right)^\dagger = \langle\psi; \hat{\pi}^0|(\hat{M}^3)^\dagger = (2\pi\Phi)^*\langle\psi; \hat{\pi}^1| \quad , \quad (1.2.36)$$

and the latter result may be combined with \hat{M}^3 operating to the right to show that the inverse is not the conjugate transpose:

$$\langle\psi; \hat{\pi}^0|(\hat{M}^3)^\dagger\hat{M}^3|\psi; \hat{\pi}^0\rangle = (2\pi\Phi)^*2\pi\Phi \quad \implies \quad (\hat{M}^3)^\dagger \neq (\hat{M}^3)^{-1} \quad . \quad (1.2.37)$$

\hat{M}^3 is not a unitary operator.

Now we will suggest a context in which the non-unitary property of \hat{M}^3 will define unique MCM physics. Recalling

$$\begin{aligned} \hat{M}_1|\psi; \hat{\pi}^0\rangle &= \pi|\psi; \hat{\Phi}^0\rangle \\ \hat{M}_2|\psi; \hat{\Phi}^0\rangle &= \Phi|\psi; \hat{2}^1\rangle \\ \hat{M}_3|\psi; \hat{2}^1\rangle &= 2|\psi; \hat{\pi}^1\rangle \quad , \end{aligned} \quad (1.2.38)$$

consider $\hat{M}_3\hat{M}_2\hat{M}_1 = \hat{\pi}2\hat{\Phi}$ where $\hat{\Phi}$ obeys

$$\left. \begin{array}{l} \hat{\varphi}^\dagger = \hat{\Phi} \\ \hat{\Phi}^\dagger = -i\hat{\varphi} \end{array} \right\} \implies \hat{\varphi}^{\dagger\dagger} = -i\hat{\varphi} \neq \hat{\varphi} \quad . \quad (1.2.39)$$

The general meaning of $\hat{\varphi}$ is as in the previous section. It indicates the χ_-^4 direction rather than the $-\chi_+^4$ direction. The bold operators are cast as

$$\hat{\Phi} \sim \hat{O}_{\mathcal{H} \rightarrow \Omega} \quad , \quad \hat{2} \sim \hat{O}_{\Omega \rightarrow \mathcal{A}} \quad , \quad \text{and} \quad \hat{\pi} \sim \hat{O}_{\mathcal{A} \rightarrow \mathcal{H}} \quad . \quad (1.2.40)$$

Hermitian conjugation yields

$$\left(\hat{\pi} \hat{2} \hat{\Phi}|\psi; \hat{\pi}^k\rangle\right)^\dagger = -i\langle\psi; \hat{\pi}^k|\hat{\varphi} \hat{2}^\dagger \hat{\pi}^\dagger \quad . \quad (1.2.41)$$

This expression is intended to say that $\hat{2}^\dagger$ and $\hat{\pi}^\dagger$ will send states back the way they came through the cosmological lattice, but $\hat{\varphi}$ does not reverse $\hat{\Phi}$. We may imagine that $\hat{\varphi}$ sends the $\langle\psi; \hat{\pi}^k|$ bra up the χ_-^4 number line (Figure 4) rather than back down in the direction from which it came. Therefore, one would write

$$\langle\psi; \hat{\pi}^k|(\hat{M}^3)^\dagger\hat{M}^3|\psi; \hat{\pi}^k\rangle = \langle\psi; \hat{\pi}^k|(\hat{\varphi} \hat{2}^\dagger \hat{\pi}^\dagger) \hat{\pi} \hat{2} \hat{\Phi}|\psi; \hat{\pi}^k\rangle = c\langle\psi; \hat{\pi}^{k''}|\psi; \hat{\pi}^{k'}\rangle \quad . \quad (1.2.42)$$

The k' and k'' notation at the right exposes what may be a shortcoming of the convention to assign levels of aleph to entire unit cells rather than individual branes. A single integer k is inadequate for labeling the branes which are off the beaten path of \hat{M}^3 (such as those indicated by $\hat{\varphi}$.) A more formal statement might include levels of aleph (quantum numbers) for all of the ontological basis vectors so that branes are labeled by sequences of integers. This more complicated MCM lattice structure is intuitive in Figure 4b, but it is not needed in the usual representation of the unit cell.

$(\hat{M}^3)^\dagger$ has no ordinary use because the process of observation and measurement is constrained by a psychological arrow of time; a theory of making observations in reverse time order could never be tested, seemingly. However, the full analysis of a theory includes all possible operations and manipulations, such as time reversal operations, which would come in chronological and chirological varieties. $\hat{\varphi}$ is introduced to make the chirological time reversal operator more than a trivial variation on the chronological one. It is considered desirable for physics that \hat{M}^3 and $(\hat{M}^3)^\dagger$ should have the sort of behavior inherent to the conjugation algebra for \mathbb{C}^* because it represents a physical condition of time irreversibility. All possibilities for such functioning are predicated on the non-unitary property of \hat{M}^3 . If \hat{M}^3 was unitary, call it \hat{M}^3 , then

$$\langle \psi; \hat{\pi}^k | (\hat{M}^3)^\dagger \hat{M}^3 | \psi; \hat{\pi}^k \rangle = \langle \psi; \hat{\pi}^k | \mathbb{1} | \psi; \hat{\pi}^k \rangle = 1 \quad , \quad (1.2.43)$$

and there would be no possibility for more complicated behaviors. Thus, the non-unitary property is introduced in anticipation of further applications.

1.2.6 The Hierarchy Problem

The hierarchy problem asks about the origin of very large and very small numbers in physics. As an example, it asks why the weak force is more than 20 orders of magnitude stronger than gravitation. It is hoped that non-unitary chirological evolutions, ones involving effects such as tunneling and/or interference across various levels of aleph, will motivate such disparate numerical scales. Very small numbers would pertain to lower levels of aleph $\sim (2\pi\Phi)^{-k}$, and large numbers would pertain to higher levels $\sim (2\pi\Phi)^k$. Such effects were previously invoked to compute the 10^{-4}m scale for new MCM physics (Section 15). In later sections, we will develop a case for infinite relative scale among unequal levels of aleph: scale beyond the present irrational scale factor $2\pi\Phi$. If successive levels of aleph are associated with infinite relative scale, one might obtain appropriate hierarchical structures as the limits of uncertainty relationships where finite scale becomes indistinguishable from infinite scale.

1.2.7 Numerical Results

Responding to an observation that the ontological basis is chosen as a wild guess, it is pointed out that no less than three important dimensionless constants fall out of the choice without much complexity added in the path of computation.

- The fine structure constant α_{MCM} can be generated with the ontological numbers. α_{MCM} is treated in Section 1.9 where a $\sim 0.4\%$ discrepancy with the accepted experimental value α_{QED} is discussed.
- The dimensionless constant 8π from Einstein's equation appears in a natural way as well (Section 1.10).
- The classical EM coupling constant $(4\pi)^{-1}$ appears in what is called **the ontological resolution of the identity**:

$$\mathbb{1} \equiv \hat{1} = \frac{1}{4\pi} \hat{\pi} + \frac{\varphi}{4} \hat{\Phi} + \frac{1}{8} \hat{2} - \frac{i}{4} \hat{i} . \quad (1.2.44)$$

It is hoped that the ontological resolution of the identity will function as a scaffold on which to unify the four fundamental forces, or possibly the strong, weak, and EM forces with a hypothetical fifth force since gravitation is geometry, not force.

1.3 Tensor States

It was stated in [3] that MCM states specified with the ontological basis are tensor states. Proof that such states satisfy the tensor transformation law has not appeared previously. In this section, we will deviate from this book's theme of open problems to present a complete result: demonstration of tensor transformations for MCM states.

Wavefunctions satisfy the axioms of a vector space as follows.

- The vacuum state $|0\rangle$ is the zero vector $\vec{0}$.
- The sum (superposition) of two state vectors is another state vector.
- The (inner) product of two states is a non-state scalar.
- For a scalar c and a state $|\psi\rangle$, the product $c|\psi\rangle$ is still a state vector.

If there exist axioms of a tensor space, they are not known as well as the axioms of a vector space. To show that something is a tensor, one demonstrates the tensor transformation law which contains vector transformations as its simplest non-trivial case. However, it is not immediately intuitive that QM states satisfy the vector transformation law in the usual sense of coordinate transformations because the geometric

picture of coordinates in state space plays little to no role in the ordinary practice of QM. Therefore, the structural framework for such a demonstration may enhance one's understanding of the theory. In this section, we will illuminate a little remarked upon feature of state spaces: they are coordinate spaces exactly like \mathbb{R}^n . Then we will make proofs of vector and tensor transformations for QM and MCM states respectively.

1.3.1 The Coordinates of State Space

To the extent that \mathbb{R}^3 is spanned by $\{\hat{x}, \hat{y}, \hat{z}\}$, an N -dimensional quantum state space is \mathbb{R}^N spanned by $\{\hat{e}_1, \hat{e}_2, \dots, \hat{e}_N\} = \{|\psi_1\rangle, |\psi_2\rangle, \dots, |\psi_N\rangle\}$ where $\{|\psi_k\rangle\}$ is some orthonormal basis. The \mathbb{R}^N structure of state space requires us to treat the spanning basis vectors $|\psi_k\rangle$ as static objects though they are the main dynamical objects in QM. The vectors that span a Hilbert space are static because there is a unique Hilbert space associated with each time t . However, the \mathbb{R}^N picture of a static basis is useful for envisioning the time evolution of quantum states. Given

$$\hat{A}|a_k\rangle = a_k|a_k\rangle \quad , \quad \text{and} \quad |\psi, t\rangle = \sum_{k=1}^N c_k(t)|a_k\rangle \quad , \quad (1.3.1)$$

one understands that $|\psi, t\rangle$ is a vector sweeping through the \mathbb{R}^N spanned by $\{|a_k\rangle\}$. The $|a_k\rangle$ eigenbasis is the geometric spanning basis of the space of states written in that basis. Although a Hilbert space is technically the space of states at some constant time t , time evolution may be understood as a continuous evolution in a state space spanned by an eigenbasis of stationary states. Time evolution described by a sweeping vector $|\psi, t\rangle$ is simplified by the unitarity constraint: the tip of $|\psi, t\rangle$ always lies on the N -dimensional unit sphere such that

$$\langle\psi, t|\psi, t\rangle = \sum_k c_k^\dagger(t)c_k(t) = 1 \quad , \quad (1.3.2)$$

where $c_k(t)$ is as in (1.3.1). The components of a vector in the $\{|a_k\rangle\}$ basis are written as (c_1, c_2, \dots, c_N) , so (1.3.2) defines a point on the unit sphere whose equation is $\sum x_k^2 = 1$. The *coordinates of state space* are such that the $x_k(t)$ Cartesian coordinates are replaced with the $c_k(t)$ coefficients in the expansion of $|\psi, t\rangle$. State space has this structure for geometric interpretation, but quantum theory is not such that one refers to such things in practice. Here, we will use it to demonstrate compliance with vector and tensor transformation laws in a mathematically rigorous way. This will exceed the compliance usually demonstrated through the above bulleted axioms of a vector space.

1.3.2 The Vector Transformation Law

Vector notation is such that

$$\mathbf{x} = \sum_k a^k \hat{e}_k \quad \Longrightarrow \quad x^\mu = a^\mu \quad . \quad (1.3.3)$$

At first glance, we can tell that ordinary states and MCM states are vectors and tensors respectively from

$$|\psi\rangle = \sum_k a^k |a_k\rangle \quad \Longrightarrow \quad \psi^\mu = a^\mu \quad , \quad (1.3.4)$$

and its generalization as an MCM state

$$|\psi; \hat{e}_\mu\rangle = \sum_k a_k |a_k\rangle \hat{e}_\mu \quad \Longrightarrow \quad \psi_{\mu\nu} = a_\mu \hat{e}_\nu \quad . \quad (1.3.5)$$

A one index tensor is a vector, and a vector with an extra index is a tensor. However, this is not a formal demonstration of the transformation law. A more formal statement of the law would be the following.

For a unit vector \hat{n} and an angle ϕ , let $\hat{R}(\hat{n}, \phi)$ be a rotation operator. Suppose $|\psi\rangle = |a\rangle + |b\rangle$. If \hat{R} preserves the “angle” between $|a\rangle$ and $|b\rangle$, meaning that $\hat{R}|\psi\rangle = \hat{R}|a\rangle + \hat{R}|b\rangle$ is such that $\hat{R}|a\rangle$ and $\hat{R}|b\rangle$ are still orthogonal if $|a\rangle$ and $|b\rangle$ were orthogonal, then $|\psi\rangle$ transforms as a vector.

If two orthogonal objects belong to a vector space, then they will remain orthogonal under coordinate transformations. If ψ is not written in the position space representation, then the details become modestly more complicated because the rotation operator, which is only one example of a coordinate transformation, must pertain to the coordinates of state space. As it is usually understood, \hat{n} indicates some spatial rotation axis in an \mathbb{R}^3 lab frame. It does not make sense to rotate a state around such an axis when the state is not written in the position basis. Instead, we must generalize to the case where \hat{n} points in an abstract direction defined according to the $\{|a_k\rangle\}$ spanning states instead of the $\{\hat{x}, \hat{y}, \hat{z}\}$ basis that spans \mathbb{R}^3 . Indeed, we must generalize to the case of arbitrary coordinate changes in state space. Consideration of rotations alone will not suffice for a rigorous demonstration.

As a thinking device, one might consider the 2D space of electron spin states

$$\hat{x} \equiv \hat{e}_1 = |\uparrow\rangle \quad , \quad \text{and} \quad \hat{y} \equiv \hat{e}_2 = |\downarrow\rangle \quad . \quad (1.3.6)$$

These states transform as spinors under rotations of the lab frame (physical space), but they transform as vectors under rotations of state space. The state space spanned by these eigenstates is \mathbb{R}^2 . The well-known time evolution of these states is visualized as the tip of a vector moving on the unit circle.

To formally demonstrate the vector transformation law for a vector in \mathbb{R}^N , let x be a coordinate system in \mathbb{R}^N , and let there be a coordinate transformation

$$x' = f(x) \quad , \quad \text{such that} \quad x'^{\mu} = T_{\nu}^{\mu} x^{\nu} \quad . \quad (1.3.7)$$

Let $\mathbf{v} = v^{\mu}$ be a vector in \mathbb{R}^N written in the x coordinates. It follows that

$$\mathbf{v} = \sum_k^n x^k \hat{e}_k \quad \Longrightarrow \quad \begin{cases} \mathbf{v} = x^{\mu} \hat{e}_{\mu} \\ v^{\mu} = x^{\mu} \end{cases} \quad . \quad (1.3.8)$$

\mathbf{v} is anchored at the origin of the x coordinate system, and its tip is at the point x . In conventional notation, the most general statement of the vector transformation law for vectors in \mathbb{R}^N is

$$v'^{\mu} = v^{\nu} \frac{\partial x'^{\mu}}{\partial x^{\nu}} \quad , \quad (1.3.9)$$

where $\mathbf{v}' = v'^{\mu}$ is \mathbf{v} written in the transformed x' coordinates. Following the form of (1.3.8), we may write

$$\mathbf{v}' = \sum_k^n x'^k \hat{e}'_k \quad \Longrightarrow \quad \begin{cases} \mathbf{v}' = x'^{\mu} \hat{e}'_{\mu} \\ v'^{\mu} = x'^{\mu} \end{cases} \quad . \quad (1.3.10)$$

Taking the derivative of (1.3.7) with respect to x^{ν} gives

$$\frac{\partial x'^{\mu}}{\partial x^{\nu}} = T_{\nu}^{\mu} \quad . \quad (1.3.11)$$

Substitution into (1.3.9) gives

$$v'^{\mu} = v^{\nu} T_{\nu}^{\mu} \quad . \quad (1.3.12)$$

Substituting $v^{\nu} = x^{\nu}$, we obtain

$$v'^{\mu} = x^{\nu} T_{\nu}^{\mu} = x'^{\mu} \quad , \quad (1.3.13)$$

where the second equality follows from (1.3.7). The result agrees with (1.3.10). Therefore, the vector transformation law is satisfied by vectors in \mathbb{R}^n under arbitrary coordinate transformations, as is obvious since our objects were taken as vectors a priori.

1.3.3 Vector Transformations for Ordinary States

To demonstrate the above transformation with state vectors in Hilbert space, we write the vector transformation law as

$$\psi'^{\mu} = \psi^{\nu} \frac{\partial x'^{\mu}}{\partial x^{\nu}} . \quad (1.3.14)$$

In this case, it may not be obvious what are x and x' , or what is meant by ψ and ψ' . Noting that a general state vector is written as

$$|\psi\rangle = \sum_k^N \alpha_k |a_k\rangle \implies \psi^{\mu} = \alpha_{\mu} ,^1 \quad (1.3.15)$$

we see that $\mathbf{v} = \sum_k v_k \hat{e}_k$ implies $v_k \rightarrow \alpha_k$ and $\hat{e}_k \rightarrow |a_k\rangle$. What we have demonstrated as a coordinate transformation in the previous section will now be phrased as the familiar change of basis operation. The coordinate systems x and x' will be two different operator eigenbases. In (1.3.15), we have implicitly used $\hat{A}|a_k\rangle = a_k|a_k\rangle$ to expand ψ in the eigenbasis of \hat{A} . ψ' will be the expansion in another eigenbasis. To rewrite $|\psi\rangle$ in terms of the eigenstates of some other operator \hat{B} such that $\hat{B}|b_k\rangle = b_k|b_k\rangle$, we insert the completeness relation

$$\mathbb{1} = \sum_j^N |b_j\rangle\langle b_j| , \quad (1.3.16)$$

into (1.3.15). This yields

$$|\psi\rangle = \sum_k^N \alpha_k \mathbb{1} |a_k\rangle = \sum_k^N \sum_j^N \alpha_k |b_j\rangle\langle b_j|a_k\rangle . \quad (1.3.17)$$

Now we obtain the coordinate transformation analogue

$$\beta_j = \sum_k^N \alpha_k \langle b_j|a_k\rangle , \quad (1.3.18)$$

with which to write

$$|\psi\rangle = \sum_j^N \beta_j |b_j\rangle .^2 \quad (1.3.19)$$

¹Here we have intermingled tensor and matrix index notation, as is usual in physics. If desired, one might write α^{μ} so that the indices balance as $\psi^{\mu} = \alpha^{\mu}$. In any case, (1.3.15) follows a standard physical convention in which expansion coefficients are labeled with lower indices.

This is the expression for what we have called \mathbf{v}' in the previous section. It is the same state vector written in another eigenbasis, which is like another coordinate system in the geometric picture of state space. This is the ψ' appearing in (1.3.14). Switching from summation notation to matrix multiplication notation, (1.3.18) becomes

$$\beta_j = \alpha_k T_{jk} \quad , \quad (1.3.20)$$

for the transformation matrix whose elements are $T_{jk} = \langle b_j | a_k \rangle$. Notice that (1.3.20) is in the form of (1.3.7) with $x'^\mu \rightarrow \beta_j$ and $x^\nu \rightarrow \alpha_k$. Now that we have very clearly spelled out all of the details, we may write the vector transformation law for quantum state vectors, (1.3.14), as

$$\psi'^j = \psi^k \frac{\partial \beta_j}{\partial \alpha_k} \quad . \quad (1.3.21)$$

The derivative follows from (1.3.20) as

$$\psi'^j = \psi^k \frac{\partial}{\partial \alpha_k} (\alpha_k T_{jk}) = \psi^k T_{jk} \quad . \quad (1.3.22)$$

Substituting the j^{th} coefficient from (1.3.19) on the left, and the k^{th} coefficient from (1.3.15), we obtain

$$\beta_j = \alpha_k T_{jk} \quad . \quad (1.3.23)$$

This is true by (1.3.20). Now we have proven that vectors in state space transform exactly like vectors in coordinate space. Such functioning is not highly useful for QM as practiced, but the result is valid.

1.3.4 Tensor Transformation of MCM States

For a two-index tensor, the tensor transformation law is

$$\psi'^{\mu\nu} = \psi^{\kappa\lambda} \frac{\partial x'^\mu}{\partial x^\kappa} \frac{\partial x'^\nu}{\partial x^\lambda} \quad . \quad (1.3.24)$$

Using the definition $\psi_{\mu\nu} = |\psi; \hat{e}_\nu\rangle = \psi_\mu \hat{e}_\nu$, we have already shown that the μ index transforms correctly. The coordinates relevant to transformations of the other index are those specified by

$$\begin{aligned} \psi \in \mathcal{A} & \iff |\psi\rangle = |\psi; \hat{2}\rangle = \psi(x_-^i) \\ \psi \in \mathcal{H} & \iff |\psi\rangle = |\psi; \hat{\pi}\rangle = \psi(x^i) \end{aligned} \quad (1.3.25)$$

²The sum over k and j both go to N because change of basis operations should preserve the dimensionality of the Hilbert space.

$$\begin{aligned} \psi \in \Omega &\iff |\psi\rangle = |\psi; \hat{2}\rangle = \psi(x_+^i) \\ \psi \in \emptyset &\iff |\psi\rangle = |\psi; \hat{i}\rangle = \psi(x_\emptyset^i) . \end{aligned}$$

Rather than general coordinate transformations, we will demonstrate coordinate transformations among the physical coordinates of \mathcal{A} , \mathcal{H} , and Ω (and possibly \emptyset .) Since the scope of transformations is limited, it will suffice to demonstrate a single case. We will use the transformation from the $\hat{\pi}$ coordinates to the $\hat{\Phi}$ coordinates so that x is the unprimed coordinate, and x_+ is the primed coordinate.

Using the transformation operator $\hat{\mathcal{O}}$ (Section 1.2.1) rather than the transformation matrix T , we have

$$\hat{\mathcal{O}}_{\mathcal{H} \rightarrow \Omega} x \hat{\pi} = x_+ \hat{\Phi} . \quad (1.3.26)$$

Following the example for $\hat{\mathcal{O}}$ given by (1.2.22), we obtain

$$\hat{\mathcal{O}}_{\mathcal{H} \rightarrow \Omega} x \hat{\pi} = \hat{\mathcal{O}}_{\mathcal{H} \rightarrow \Omega} \left(\frac{\Phi}{\hat{\Phi}} x \hat{\pi} \right) = \frac{\pi}{\hat{\Phi}} x \hat{\Phi} \implies x_+ = \frac{\pi}{\hat{\Phi}} x . \quad (1.3.27)$$

It follows that

$$\frac{\partial x_+^\nu}{\partial x^\lambda} = \frac{\pi}{\hat{\Phi}} \delta_\lambda^\nu , \quad \text{and} \quad \frac{\pi}{\hat{\Phi}} \delta_\lambda^\nu = T_\lambda^\nu , \quad (1.3.28)$$

where T_λ^ν is the transformation matrix between the physical coordinates in \mathcal{H} and those in Ω . One might write $\hat{\mathcal{O}}_{\mathcal{H} \rightarrow \Omega} = T_\lambda^\nu$. To verify tensor transformations for MCM states, it only remains to obtain the $\psi^{\mu\nu} = |\psi; \hat{\Phi}\rangle$ state for comparison with (1.3.24):

$$\hat{\mathcal{O}}_{\mathcal{H} \rightarrow \Omega} |\psi; \hat{\pi}\rangle = \hat{\mathcal{O}}_{\mathcal{H} \rightarrow \Omega} \left(\frac{\Phi}{\hat{\Phi}} |\psi\rangle \hat{\pi} \right) = \frac{\hat{\Phi}}{\hat{\Phi}} |\psi\rangle \pi = \frac{\pi}{\hat{\Phi}} |\psi; \hat{\Phi}\rangle . \quad (1.3.29)$$

This demonstration for the ν index suffices to verify the tensor transformation law for MCM states.

1.4 MCM Spin Spaces

The proposed structure for MCM spin state space configurations [6] is such that states in \mathcal{H}_0 reference local elements of the unit cell or those in higher and lower levels of aleph. It was suggested in Section 1.2.4 that χ_\pm^4 might be made complex in the direction out of the page but mutually orthogonal and still orthogonal to x^i , as in Figure 5. In this section, we will suggest the same for x^0 and x_\pm^0 : the chronological times in \mathcal{H} , \mathcal{A} , and Ω .

Spin-1/2 state space is canonically constructed as $L^2(\mathbb{R}^3) \otimes \mathbb{C}^2$ where $L^2(\mathbb{R}^3)$ is the spinless state space and \mathbb{C}^2 is a 2D complex vector space. In the MCM protocol, the

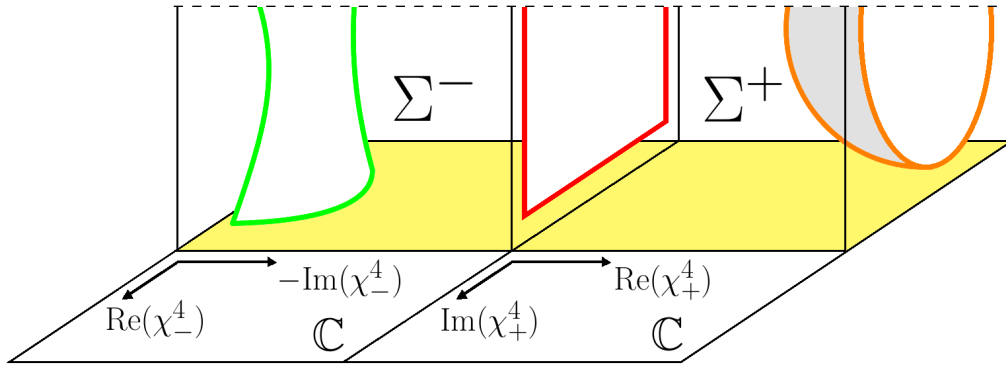

Figure 5: This figure demonstrates that we may take χ_{\pm}^4 as complex variables whose real and imaginary parts span Σ^{\pm} respectively.

spin-1/2 state space is constructed as

$$L^2(\mathbb{R}^3) \otimes \chi_{+\{0\}}^4 \otimes \chi_{-\{0\}}^4 \quad . \quad (1.4.1)$$

$\chi_{\pm\{0\}}^4$ are a pair of complex numbers whose respective real and imaginary parts are the $\chi_{\pm}^4 \in \Sigma^{\pm}$ on the zeroth level of aleph. Across the unit cell, χ_{+}^4 and χ_{-}^4 are uniquely real and imaginary, but they are both complex when we take their mutually orthogonal transverse continuations onto \mathbb{C} . The spin-1 state space is canonically constructed as $L^2(\mathbb{R}^3) \otimes \mathbb{C}^3$ where \mathbb{C}^3 is a 3D complex vector space. In the MCM, we use

$$L^2(\mathbb{R}^3) \otimes x_{+\{0\}}^0 \otimes x_{\{0\}}^0 \otimes x_{-\{0\}}^0 \quad , \quad (1.4.2)$$

where $\text{Im}(x_{\{k\}}^0)$ is the x^0 coordinate in \mathcal{H}_k generating the minus sign in the $\{-++\}$ signature of Minkowski space. $x_{\pm\{k\}}^0$ are also understood to be complex.

For fermionic spin- $\frac{2N-1}{2}$ with $N > 1$, usually $L^2(\mathbb{R}^3) \otimes \mathbb{C}^{2N}$, we take the tensor product of (1.4.1) with $\chi_{\pm\{k\}}^4$ on other levels of aleph: however many are needed to assemble the requisite spin degrees of freedom. This yields

$$L^2(\mathbb{R}^3) \bigotimes_{k=0}^{N-1} \chi_{\pm\{k\}}^4 \quad . \quad (1.4.3)$$

If allowing $\chi_{\pm\{k\}}^4$ to become complex is found to be too complicated or needlessly complicated, we might construct the spin- $\frac{2N-1}{2}$ state space as

$$L^2(\mathbb{R}^3) \bigotimes_{k=0}^{\frac{N-1}{2}} (\chi_{-\{k\}}^4 \oplus \chi_{+\{k-1\}}^4) \otimes (\chi_{+\{k\}}^4 \oplus \chi_{-\{k+1\}}^4) \quad , \quad (1.4.4)$$

where the χ^4 variants are strictly real or imaginary, and \mathbb{C}^N is formed from N such pairs. For $N=1$, this expression gives

$$L^2(\mathbb{R}^3) \otimes (\chi_{-\{0\}}^4 \oplus \chi_{+\{-1\}}^4) \otimes (\chi_{+\{0\}}^4 \oplus \chi_{-\{1\}}^4) \quad . \quad (1.4.5)$$

Each parenthetical pair of strictly real or imaginary χ_{\pm}^4 constitutes one instance of \mathbb{C} . (1.4.5) generates the correct $L^2(\mathbb{R}^3) \otimes \mathbb{C}^2$ spin-1/2 state space without requiring χ_{\pm}^4 to have simultaneous real and imaginary parts.

For bosonic spin- N , increasing N requires that we alternately add instances of $x_{\{k\}}^0$ and $x_{\pm\{k\}}^0$ for odd or even N , but a regular recursion formula is not simply obtained. For spin-2, we have

$$L^2(\mathbb{R}^3) \otimes x_{-\{1\}}^0 \otimes x_{+\{0\}}^0 \otimes x_{\{0\}}^0 \otimes x_{-\{0\}}^0 \otimes x_{+\{-1\}}^0 \quad . \quad (1.4.6)$$

For spin-3, we have

$$L^2(\mathbb{R}^3) \otimes x_{\{1\}}^0 \otimes x_{-\{1\}}^0 \otimes x_{+\{0\}}^0 \otimes x_{\{0\}}^0 \otimes x_{-\{0\}}^0 \otimes x_{+\{-1\}}^0 \otimes x_{\{-1\}}^0 \quad , \quad (1.4.7)$$

and so forth. It is not immediately obvious what construction might avoid allowing x^0 to become complex in the manner of (1.4.4).

In Section 13, we will show a nice application of this spin space construction toward supersymmetry between bosons and fermions.

1.5 Maximum Action

Quantum and classical probabilities differ in that unmeasured, intermediate steps of quantum motion between two measurements cannot be inferred from those measurements.¹ If a twice-measured classical ball rolls down a ramp, it has a definite position at each instant during the motion. The motion can be inferred from either measurement, even if one looks away while the ball is rolling. The path is the one that minimized the action. The ball's wavefunction does not diffuse. It is always collapsed. For a quantum particle moving on some analogous energy landscape, the position of the particle is not knowable while one is looking away. If a quantum ball is observed at a location with higher energy and then at one with lower energy, and in the absence of any intermediate measurements, it may not have followed the path which minimized the action. Indeed, the most common interpretation of QM is that a quantum particle does not follow *any* path between consecutive measurements. Between measurements, a position state is said to undergo *decoherence* [77] such that it

¹See Sections 2-4 in [68] or Section I.2 in [76] for a concise comparison of classical and quantum probabilities.

evolves into an increasingly diffuse superposition of eigenstates conglomerated about the classical trajectory. Decoherence is the heatlike diffusion of probability amplitude given by the Schrödinger equation: a complex heat equation. When one looks, the wavefunction collapses. Contrary to the classical case, the wavefunction diffuses while one looks away. The longer one looks away from a quantum state, the more likely it is to be found away from the path of classical motion.

The main insight in Feynman’s formulation of non-relativistic quantum mechanics [68] was to show that the probability amplitude for the particle having followed one path or another is a fuzzy distribution proportional to the action along each path. The classical trajectory minimizes the action, so the probability amplitude is greatest along that path. The more a path fails to extremize the action, the less probable it is that the particle might be observed along that path.

The usual formulation of QM is such that nothing other than diffusion happens between two consecutive measurements A and B . The main purpose in writing \hat{M}^3 as three separate operations is to hard-code into the motion stops on Ω and \mathcal{A} between successive \mathcal{H} so as to increase the richness of possible dynamics. Though measurements can only be made in \mathcal{H} (the universe), the MCM postulates by construction that there exists definite knowledge that the state was located on Ω and \mathcal{A} between t_0 and t_1 corresponding to measurements A and B . Using intuitive notation such that $t_0 < t_\Omega < t_{\mathcal{A}} < t_1$, we know that MCM states “collapse” to $|\psi, t_\Omega; \hat{\Phi}\rangle$ and $|\psi, t_{\mathcal{A}}; \hat{\Delta}\rangle$ between measurements A and B (corresponding to states $|\psi, t_0; \hat{\pi}^0\rangle$ and $|\psi, t_1; \hat{\pi}^1\rangle$.) Additional knowledge of the state at the intermediate times t_Ω and $t_{\mathcal{A}}$ is part of what is meant when it is said that \hat{M}^3 is purposed to make things more complicated than what is understood for ordinary operations in QM. At minimum, additional complexity is manifested by three separate time evolutions $\mathcal{H} \rightarrow \mathcal{A} \rightarrow \Omega \rightarrow \mathcal{H}$ where the sign convention for the arrow of time differs between Σ^+ and Σ^- . In Section 1.8.5, we will discuss an application in which Schrödinger evolution by negative time might implement a period of wavefunction collapse following a period of wavefunction diffusion in positive time.

It is a conjecture of the MCM that quantum and classical motions differ in the way that they satisfy the action principle. Classical motion minimizes action, and quantum motion maximizes it. It is taken for granted that motion along any path totally within \mathcal{H} must be associated with some finite action. Therefore, the path which leaves the universe (\mathcal{H}) to cross the unit cell is associated with infinite action. For the purposes of physics, what is usually called finite action may be defined as action less than some natural number of finite action increments: $n\hbar$ with $n \in \mathbb{N}$, for

example. In the language of fractional distance analysis (Section 1.6) [2], a natural number of units of action is called an action in the neighborhood of the origin. By default, **action in the neighborhood of infinity** remains to characterize motion across the unit cell. The neighborhood of infinity may be characterized as the set of numbers in the form $\widehat{\infty} \pm b$ with $0 < b < n$ for some $n \in \mathbb{N}$. Numbers in the form $\widehat{\infty} - b$ are finite numbers because they are less than infinity. (Notations for $\widehat{\infty}$ are developed in Section 1.6 and [2].) Thus, one is able to use such numbers to characterize motion across the unit cell without violating a physical convention prohibiting infinite or transfinite quantities of action. Action greater than infinity would allow superluminal motions, etc. Many properties of action in the neighborhood of infinity remain to be determined.

Any action in the neighborhood of infinity will be one which takes the state out of \mathcal{H} . Such an action makes an immediate appeal to the correspondence principle: when action is large compared to \hbar , motion should approach the classical motion. In other words, large action impedes the diffusion of the wavefunction. Thus, knowledge regarding states' definite location on the Ω - and \mathcal{A} -branes between sequential \mathcal{H} -branes is supported by the correspondence principle. Classical motion is characterized by definite knowledge of the path between A and B . In the example of the classical ball on a ramp, the action of the ball's motion is always large relative to \hbar due to the ball's macro-scale mass. In QM, one often considers *large action* as the limit in which $\hbar \rightarrow 0$, but here we will consider $\mathcal{S} \rightarrow \widehat{\infty}$. The arithmetic of numbers in the neighborhood of infinity [2] is well suited to the calculus of variations with variations in the form $\mathcal{S} = \widehat{\infty} \pm \delta\mathcal{S}$. To the contrary, $\mathcal{S} \rightarrow \infty$ is a prime example of the "infinities that blocked earlier theories" [70]. $\mathcal{S} = \infty$ is a mathematical non-starter for calculus, and the study of maximum action has been historically impossible for this reason. For instance, Hamilton's stationary action principle requires any action extremum, big or small, but Feynman's thesis was titled "The Principle of Least Action in Quantum Mechanics" because greatest action was a non-starter at that time. A principle of greatest action in QM is presented here as a thesis awaiting completion, i.e.: the equations of motion given by \hat{M}^3 should satisfy the greatest action principle.

In the $\hbar \rightarrow 0$ limit, or in the $\mathcal{S} \rightarrow \widehat{\infty}$ limit, one obtains a classical motion identically. Identical classical motion during transit of the unit cell is not consistent with the structure of the MCM because KKT requires that the 5D Ricci tensor R_{AB} must vanish in the bulk of Σ^\pm . If a particle with mass and energy follows a classical path across Σ^\pm , then $R_{AB}^\pm \neq 0$ and the structure of the MCM will seem to collapse in self-contradiction.¹ Thus, it is required that a quantum of matter-energy should not be

¹The full restrictions of KKT require in-depth analysis, as in Section 17. It is the preliminary understanding that

found with a definite position inside the bulk, and an appeal is made to finite action in the neighborhood of infinity. Unlike $\mathcal{S}=\widehat{\infty}$, finite action in the form $\widehat{\infty} - \delta\mathcal{S}$ with $\delta\mathcal{S} > 0$ may not require total wavefunction collapse within the bulk, so the utility of such an action toward preserving the structure of KKT must be examined. A pseudo-classical path of totally classical motion would be the one along which $\mathcal{S}=\widehat{\infty}$. This is an extremum of the action, and motion along this singular path cannot be quantum. However, since measurements are not made in the bulk, we may send a particle across the unit cell by *all paths* whose actions are $\mathcal{S}=\widehat{\infty} - \delta\mathcal{S}$. Quantum states may transit the unit cell without taking any one explicit path or forcing a non-vanishing Ricci tensor. In this case, it will remain to demonstrate that a non-zero probability amplitude in the bulk of Σ^\pm is still consistent with an $R_{AB}=0$ solution.

The existence of non-trivial $R_{AB}=0$ solutions such as gravitational radiation supports the idea that a probability density for motion near the infinite action path can be consistent with $R_{AB}=0$. One might even connect the principle of maximum action to states passing from one \mathcal{H} -brane to another as gravitational waves written as perturbations in the 5D KKT metric. Furthermore, definite location on the Ω - and \mathcal{A} -branes must also be reconciled with the vanishing Ricci tensor. If $|\psi, t_\Omega; \hat{\Phi}\rangle$ and $|\psi, t_{\mathcal{A}}; \hat{\Psi}\rangle$ are not position eigenstates, then we might appeal to the same indeterminacy of the path in the bulk to avoid a Ricci tensor violation. If they are position eigenstates, or if any other issue arises, one might preserve KKT in the bulk of Σ^\pm by separating Ω and \mathcal{A} as unincluded boundaries, as \mathcal{H} is an unincluded boundary. We will say more about that possibility in Section 4. Specifically, we will discuss the case for collocating Ω and \mathcal{A} at \emptyset .

1.6 Fractional Distance and Levels of Aleph

The labeled branes of the unit cell are separated by finite distance in the abstract coordinates: χ^A as opposed to x^μ . To avoid mutual interactions, and specifically to avoid gravitation between branes, early work in the MCM sought to place \mathcal{A} , \mathcal{H} , and Ω at infinite distances with respect to one another. Due to the infinite range of the gravitational force, finite physical distance between branes would suggest gravitational collapse of the overall lattice of all unit cells. On the other hand, infinite distance is said to be unphysical, so one exciting utility for fractional distance analysis [2] is that the gravitational interaction goes to zero across any *finite* distance in the neighborhood of infinity. Indeed, the MCM requirement for branes separated by analytically tractable distances across which gravitation goes to zero was the progeni-

position eigenstates for massive particles in the bulk of Σ^\pm are not allowed.

tor of the ideation which led to the discovery of fractional distance and an interesting corollary regarding the Riemann hypothesis [2, 47–49].

1.6.1 Infinity Hat

The main output of the inquiry into fractional distance was a new algebraic object $\widehat{\infty}$. It is called **algebraic infinity** to distinguish it from ∞ , called **geometric infinity**. Informally, $\widehat{\infty}$ was already in wide use in physics before it was formalized in [2]. In QFT for example, one often writes the integral over all of spacetime as

$$\int d^4x = \int d^3x \int dx^0 = VT \quad , \quad (1.6.1)$$

where V is the volume of space, and T is an infinite amount of time which can cancel with another T somewhere else via $T/T = 1$. This common physical method for dealing with infinity is replicated with $T = \widehat{\infty}$ and the arithmetic axioms for numbers in the neighborhood of infinity [2]. The main difference between $\widehat{\infty}$ and ∞ is that the latter has properties of additive and multiplicative absorption

$$x \in \mathbb{R} \quad \Longrightarrow \quad \begin{cases} x + \infty = \infty \\ x \times \infty = \infty \end{cases} \quad , \quad (1.6.2)$$

but $\widehat{\infty}$ does not have those properties. Its main algebraic properties are

$$\begin{aligned} \widehat{\infty} - \widehat{\infty} &= 0 \\ \frac{\widehat{\infty}}{\widehat{\infty}} &= \frac{\widehat{\infty}}{\infty} = 1 \\ 0 \times \widehat{\infty} &= 0 \\ |\widehat{\infty}| &= \infty \quad . \end{aligned} \quad (1.6.3)$$

More details regarding the properties and arithmetic of $\widehat{\infty}$ may be found in [2].

There is a theorem in [2] (Main Theorem 3.2.6) proving that some $x \in \mathbb{R}$ are greater than any $n \in \mathbb{N}$. Consequently, there exist some $x \in \mathbb{R}$ having greater than zero **fractional distance** with respect to infinity. The number $\aleph_{\mathcal{X}}$ defined by

$$\forall \mathcal{X} \in [0, 1) \quad \exists \aleph_{\mathcal{X}} \in \mathbb{R} \quad , \quad \text{such that} \quad \frac{\aleph_{\mathcal{X}}}{\infty} = \mathcal{X} \quad , \quad (1.6.4)$$

is said to have fractional distance \mathcal{X} (with respect to infinity) because $\aleph_{\mathcal{X}}/\infty = \mathcal{X}$.

The subset of \mathbb{R} containing numbers having fractional distance \mathcal{X} is labeled $\mathbb{R}^{\mathcal{X}}$, i.e.:

$$x \in \mathbb{R}^{\mathcal{X}} \quad \Longrightarrow \quad \frac{x}{\infty} = \mathcal{X} \quad . \quad (1.6.5)$$

Building on these definitions, we may write

$$\begin{aligned} \mathbb{R}^0 &= \{ x \mid -n < x < n, n \in \mathbb{N} \} \\ \mathbb{R}^{\mathcal{X}} &= \{ \aleph_{\mathcal{X}} + b \mid |b| \in \mathbb{R}^0 \} \\ \mathbb{R}^1 &= \{ \widehat{\infty} - b \mid b \in \mathbb{R}^0 \} \quad .^1 \end{aligned} \quad (1.6.6)$$

\mathbb{R}^0 is called the neighborhood of the origin. As the set of all real numbers less than some natural number (and greater than some negative natural number), every $x \in \mathbb{R}^0$ has zero fractional distance, and $\aleph_0 = 0$. When $\mathcal{X} \in (0, 1)$, $\mathbb{R}^{\mathcal{X}}$ is called an intermediate neighborhood of infinity. \mathbb{R}^1 is called the maximal neighborhood of infinity. There is more than one real number in each neighborhood because

$$\left. \begin{array}{l} \frac{\aleph_{\mathcal{X}}}{\infty} = \mathcal{X} \\ \frac{b}{\infty} = 0 \end{array} \right\} \quad \Longrightarrow \quad \frac{\aleph_{\mathcal{X}} + b}{\infty} = \frac{\aleph_{\mathcal{X}}}{\infty} + \frac{b}{\infty} = \mathcal{X} + 0 = \mathcal{X} \quad . \quad (1.6.7)$$

The positive-definite, *arithmetic* neighborhood of infinity is

$$\widehat{\mathbb{R}} = \bigcup_{\mathcal{X} \in (0, 1]} \mathbb{R}^{\mathcal{X}} \quad . \quad (1.6.8)$$

We will discuss additional numbers in the neighborhood of infinity called *non-arithmetic* numbers [2] in Section 1.6.6. The big and little parts of a real number are

$$\text{Big}(\aleph_{\mathcal{X}} + b) = \aleph_{\mathcal{X}} \quad , \quad \text{and} \quad \text{Lit}(\aleph_{\mathcal{X}} + b) = b \quad . \quad (1.6.9)$$

1.6.2 Levels of Aleph

Prior to the invention of $\widehat{\infty} = \aleph_1$, levels of aleph were introduced in [71]. The theoretical framework for levels of aleph is the area of the MCM in which the most technical progress has been made. Levels of aleph are now associated with successive neighborhoods of fractional distance.

Each unit cell is said to be on its own level of aleph. Recalling that we have placed \mathcal{A} at $\chi_-^4 = -\varphi$, \mathcal{H} at $\lim \chi_{\pm}^4 \rightarrow 0$, and Ω at $\chi_+^4 = \Phi$, a first approximation to a

¹Notation in [2] was such that \mathbb{R}^0 did not include negative numbers.

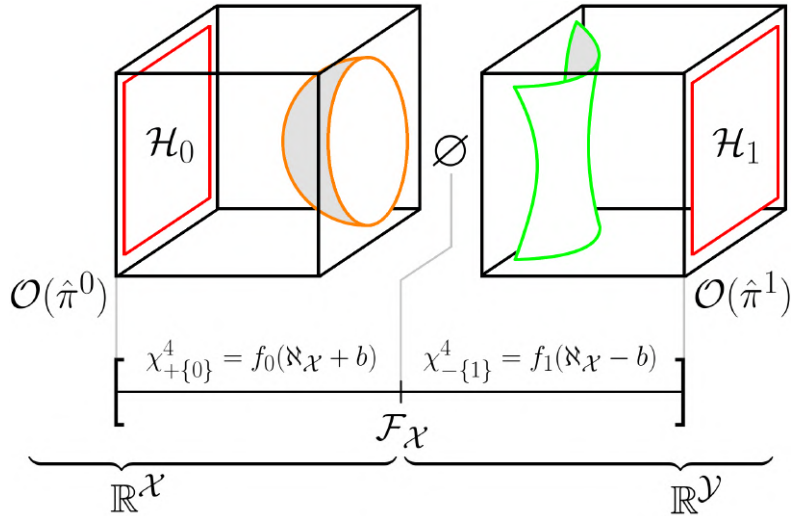

Figure 6: Relative to some absolute origin of \mathbb{R} (not pictured), the origin of coordinates $\mathcal{O}(\hat{\pi}^n)$ on the n^{th} level of aleph is placed at $\aleph_{\mathcal{X}}$, which is the midpoint of the interval representation of $\mathbb{R}^{\mathcal{X}}$. After operation with \hat{M}^3 , the observer resides on a higher level of aleph whose origin of coordinates is placed at $\aleph_{\mathcal{Y}}$. $\mathcal{F}_{\mathcal{X}}$ is an *immeasurable number* (non-arithmetic), as in Section 1.6.6.

formal definition for each unit cell being on its own level of aleph is that there exists a bijection between some $\mathbb{R}^{\mathcal{X}} \setminus \aleph_{\mathcal{X}}$ (physical coordinates) and the chirological interval $(-\varphi, 0) \cup (0, \Phi)$ (abstract coordinates) around a corresponding instance of \mathcal{H} . Since $\chi_{\pm}^4 = 0$ is not defined, bijection requires that we remove one number from the $\mathbb{R}^{\mathcal{X}}$ codomain. By removing $\aleph_{\mathcal{X}}$ and choosing $b > 0$, one obtains two separate bijections: one between $\aleph_{\mathcal{X}} - b$ and χ_{-}^4 , and one between $\aleph_{\mathcal{X}} + b$ and χ_{+}^4 , as in Figure 6. When successive \mathcal{H} -branes are on successive levels of aleph, any two instances of \mathcal{H} are automatically separated by a physical distance greater than any natural number of meters.¹ This follows because any $n \in \mathbb{N}$ and $(\aleph_{\mathcal{X}} + b) \in \mathbb{R}^{\mathcal{X}}$ are such that $(\aleph_{\mathcal{X}} + b + n)$ is still in $\mathbb{R}^{\mathcal{X}}$. Therefore, the forward \mathcal{H} -brane must be advanced in the χ^4 direction by greater than a natural number of physical distance units.

In the pure mathematical analysis of fractional distance appearing in [2], the metric along \mathbb{R} is taken as the Euclidean metric. However, the application in the MCM for successive levels of aleph to exist on different scales requires a metric such that $\text{len}(\mathbb{R}^{\mathcal{X}}) \neq \text{len}(\mathbb{R}^{\mathcal{Y}})$ when $\mathcal{X} \neq \mathcal{Y}$. Aside from the irrational, non-unit magnitude scale factor $2\pi\Phi$ inherent to $\hat{M}^3|\psi; \hat{\pi}^0\rangle = 2\pi\Phi|\psi; \hat{\pi}^1\rangle$, we might use the $\widehat{\infty}$ notation to implement a change of scale such that the length of one neighborhood is infinitely

¹There does not exist a clear requirement for an x_{\pm}^4 physical coordinate, but we will discuss the case.

great or small with respect to another. This additional scale would be implicit in the exponent on $\hat{\pi}^k$ that enumerates levels of aleph.

1.6.3 Gravitational Potential Energy

One way to avoid gravitation between branes is to suppose that there does not exist any physical counterpart to the abstract χ^4 coordinate on the fifth dimension. If the gravitational potential energy $U \neq U(\chi^4)$, then there is no Newtonian gravitation across Σ^\pm . However, it may be desirable to define a physical distance between branes in addition to the abstract distance. In that case, consider branes \mathcal{H}_1 and \mathcal{H}_2 as masses m_1 and m_2 separated by a real-valued distance \mathbf{r} such that $|\mathbf{r}| \notin \mathbb{R}^0$. Let $\mathbf{r} = \aleph_{\mathcal{X}} \hat{r}$ with $\mathcal{X} > 0$ so the gravitational potential energy is

$$U(r) = -\frac{Gm_1m_2}{\aleph_{\mathcal{X}}} = -\frac{1}{\mathcal{X}} \frac{Gm_1m_2}{\widehat{\infty}} = \frac{0}{\mathcal{X}} = 0 \quad . \quad (1.6.10)$$

It follows that \mathcal{H} -branes will not mutually gravitate if G , m_1 , and m_2 remain in the neighborhood of the origin.

We have not yet considered that a change of scale might refer to quantities other than the distances in the metric. If the scale of the level of aleph associated with \mathcal{H}_2 is such that $m_2 \notin \mathbb{R}^0$, then a non-zero gravitational energy will result, even across separations in the neighborhood of infinity. Given $m_2 = \aleph_{\mathcal{Y}}$, we have

$$U(r) = -\frac{Gm_1\aleph_{\mathcal{Y}}}{\aleph_{\mathcal{X}}} = -\frac{Gm_1\mathcal{Y}}{\mathcal{X}} \quad . \quad (1.6.11)$$

Mass in the neighborhood of infinity must be associated with curvature of spacetime in the neighborhood of infinity, indicating a likely singularity. If levels of aleph change the mass scale, one might conceive of an adjacent higher level of aleph as existing *within*, rather than beyond, a \emptyset singularity separating unit cells.

If non-zero gravitational energy is present between branes, we might consider the spin-1/2 matter particle interpretation of MCM universes to make an appeal to Pauli exclusion degeneracy pressure. This pressure will offset gravitational collapse, and it may be important in the lattice whose branes are the standard model fermions. A simpler explanation for avoiding gravitational collapse notes that the Newtonian force still vanishes for m_2 in the neighborhood of infinity if one assumes an intuitive arithmetic:

$$\mathbf{F} = \frac{Gm_1m_2}{r^2} \hat{r} = \frac{Gm_1\aleph_{\mathcal{Y}}}{\aleph_{\mathcal{X}}^2} \hat{r} \quad \propto \quad \frac{1}{\widehat{\infty}} \quad . \quad (1.6.12)$$

To avoid a vanishing Newtonian force, one would have to scale Newton's constant G

to the higher level of aleph as well. In that case, m_1 is the only remaining quantity (aside from \hat{r}) on the lower level of aleph, and \mathbf{F} mimics the force on an infinitesimal mass. In effect, we have rescaled the big and little parts of a real number as a little part and an infinitesimal part. While infinitesimal masses are not used in Newtonian gravitation, *only* infinitesimal test masses follow the geodesics usually derived in GR. All other masses' backreaction will push them away from stationary geodesics.

1.6.4 Arithmetic in the Neighborhood of Infinity

The well-known rules of arithmetic for numbers in the neighborhood of the origin are such that multiplication and division are mutually associative, e.g.:

$$x, y, z \in \mathbb{R}^0 \quad \implies \quad x \times \left(\frac{y}{z}\right) = \left(\frac{x}{z}\right) \times y \quad . \quad (1.6.13)$$

Arithmetic for $\widehat{\infty}$ and other numbers with non-vanishing fractional distance requires that division and multiplication are not mutually associative in all cases [2], e.g.:

$$x, y, z \in \mathbb{R} \quad \not\Rightarrow \quad x \times \left(\frac{y}{z}\right) = \left(\frac{x}{z}\right) \times y \quad . \quad (1.6.14)$$

Consequently, division is not identically multiplication by an inverse. Rather, division is a separate operation. Under the usual rules for associative arithmetic in the neighborhood of the origin, we might write for some $b \neq 0$

$$\aleph_{\mathcal{X}} + b = \mathcal{X} \widehat{\infty} + b \frac{\widehat{\infty}}{\infty} = \left(\mathcal{X} + \frac{b}{\infty}\right) \widehat{\infty} = (\mathcal{X} + 0) \widehat{\infty} = \aleph_{\mathcal{X}} \quad . \quad (1.6.15)$$

This implies $b=0$, a contradiction. When associativity is not taken for granted, the manipulation in (1.6.15) stalls at the second step. It is not possible to pull out a factor of $\widehat{\infty}$ to form the parenthetical expression

$$\mathcal{X} \widehat{\infty} + b \frac{\widehat{\infty}}{\infty} \quad \longrightarrow \quad \left(\mathcal{X} + \frac{b}{\infty}\right) \widehat{\infty} \quad , \quad (1.6.16)$$

because that makes an appeal to associativity, i.e.:

$$\frac{\widehat{\infty}}{\infty} \times 1 = \frac{1}{\infty} \times \widehat{\infty} \quad . \quad (1.6.17)$$

The contradiction in (1.6.15) is avoided because (1.6.14) says that (1.6.17) is not implied. If associativity were allowed, we might manipulate (1.6.17) as

$$1 = \frac{\widehat{\infty}}{\infty} = \widehat{\infty} \times \frac{1}{\infty} = \widehat{\infty} \times 0 = 0 \quad . \quad (1.6.18)$$

Assuming such associativity has produced another contradiction.

In the neighborhood of the origin, arithmetic operations are as they are usually understood. In (1.6.10), we were able to pull Gm_1m_2/\mathcal{X} out of the fraction with $\widehat{\infty}$ because $G, m_1, m_2, \mathcal{X} \in \mathbb{R}^0$. Since \hat{M}^3 moves states across levels of aleph, a formal equation for \hat{M}^3 may exceed that which can be stated using arithmetic only in the neighborhood of the origin. Acknowledging that Dirac kets are only a concise notation for states' more complicated analytical representations, the requirement that \hat{M}^3 changes the level of aleph may require that the analytical expression for $\hat{M}^3|\psi; \hat{\pi}^0\rangle = c|\psi; \hat{\pi}^1\rangle$ diverges in the neighborhood of the origin. This would follow from infinite relative scale between successive unit cells.

1.6.5 Reference Frames on Levels of Aleph

The \hat{M}^3 operator sends ψ to the next higher level of aleph. Although that operator is non-unitary, the probability interpretation is restored by a translation of the observer's frame of reference onto the corresponding level of aleph, or into the corresponding unit cell with a given scale. Having better defined what a level of aleph is, now we may better clarify the what is meant by translation onto a higher level of aleph.

The constants $2, \pi,$ and Φ that we have used in $\hat{M}^3|\psi; \hat{\pi}^0\rangle = 2\pi\Phi|\psi; \hat{\pi}^1\rangle$ all belong to \mathbb{R}^0 . Assuming $|\psi; \hat{\pi}^0\rangle$ is valued in the neighborhood of the origin (this follows from $\langle\psi|\psi\rangle = 1$ when we make accommodations for \mathbb{C}), multiplication by another number in the neighborhood of the origin such as $2\pi\Phi$ cannot yield a number in the neighborhood of infinity. The product of any two natural numbers is still less than another natural number, so the non-unit scalar constant $2\pi\Phi$ is not sufficient to alter the fractional distance of $|\psi; \hat{\pi}^0\rangle$. Instead, the exponent on $\hat{\pi}$ should denote the scale of a given level of aleph relative to that in \mathcal{H}_0 labeled with $\hat{\pi}^0$.

If the unit cell of measurement A is in the $\mathbb{R}^{\mathcal{X}}$ neighborhood, then the unit cell of measurement B belongs to the sequentially greater $\mathbb{R}^{\mathcal{Y}}$ neighborhood. Since \mathcal{X} and \mathcal{Y} belong to a continuum $[0, 1) \subset \mathbb{R}^0$, there is some nuance which must be resolved before we may label sequential neighborhoods as integer-valued levels of aleph. The countable enumeration of an uncountable set is not possible, in general.¹ The resolution to this problem comes through a physical treatment of the observer's reference frame. In general, the observer only knows about \mathcal{H} and has no way to measure χ^4 relative to some absolute origin $\mathcal{O} \notin \mathcal{H}$. In the absence of any information that might be used to calculate an absolute distance fraction \mathcal{X} , we introduce a convention such

¹Treatment of paradoxical issues pertaining to the countable enumeration of an uncountable set may be found in Section 7 of [2].

that the observer's current level of aleph is always $\hat{\pi}^0$. The normalization of all other quantities against this convention is what is meant by translation of the observer's frame of reference onto a new level of aleph. When the observer is on a given level of aleph corresponding to some $\mathbb{R}^{\mathcal{X}}$ neighborhood, the observer's origin of coordinates is placed at $\aleph_{\mathcal{X}}$. The level of aleph corresponding to the local $\mathbb{R}^{\mathcal{X}}$ neighborhood is the neighborhood of the origin in the observer's coordinates (Figure 6). After operation with \hat{M}^3 , the observer at measurement B must redefine his coordinate system so that measurement A was taken on the $\hat{\pi}^{-1}$ level of aleph in a lower neighborhood of fractional distance. When \hat{M}^3 sends a state to the next higher level, there is no requirement to determine a \mathcal{Y} that is the least real number greater than \mathcal{X} .¹ Thus, we avoid any problem pertaining to the paradoxical enumeration of uncountable objects by countable integers because distance fractions such as \mathcal{X} and \mathcal{Y} are not observable.

While an observer has no way to calculate \mathcal{X} or \mathcal{Y} relative to an absolute origin (which physics suggests should not exist), he does have information about the number of measurements he has taken. Such measurements are easily and properly labeled with integers. When we introduce a convention such that the level of aleph is regularized by defining the observer's origin of lab coordinates at the $\aleph_{\mathcal{X}}$ specified by $\hat{\pi}^n$ (Figure 6), the scale of those coordinates must also be regularized so that the probability interpretation of the wavefunction is restored after non-unitary evolution. Redefinition of the observer's coordinate system on the higher level of aleph is not only a translation, it is also a change of scale. These mechanisms and their details require further clarifications.²

1.6.6 Immeasurable Numbers

Another discovery in fractional distance analysis was the set \mathbb{F} containing all **immeasurable real numbers**, also called **non-arithmetic real numbers**. Given

$$\mathcal{X} \neq \mathcal{Y} \implies \mathbb{R}^{\mathcal{X}} \cap \mathbb{R}^{\mathcal{Y}} = \emptyset \quad , \quad (1.6.19)$$

meaning different neighborhoods of fractional distance do not intersect, the interval $\mathbb{R} = (-\infty, \infty)$ can be simply connected only if there exist real numbers not in any neighborhood of fractional distance. These are the non-arithmetic, immeasurable numbers $\mathcal{F}_{\mathcal{X}} \in \mathbb{F}$ such that $\mathcal{F}_{\mathcal{X}}$ is the least upper bound of the open set $\mathbb{R}^{\mathcal{X}}$. Pre-

¹Although real analysis has suggested previously that there cannot exist a least real number greater than another real number (or a least positive real number), fractional distance analysis seems to suggest that such numbers may exist. These issues are treated in Section 7 of [2].

²Normalization of the observer's new frame in $\mathbb{R}^{\mathcal{X}}$ back to \mathbb{R}^0 is such that numbers are altered as $(\aleph_{\mathcal{X}} \pm b) \rightarrow \pm b$. The positive-definite property of $x \in \mathbb{R}^{\mathcal{X}}$ is lost. Therefore, we might associate a reversed time arrow along χ^4 with the property of negative numbers to increase in magnitude in the opposite direction to the increase of positive numbers.

viously in the history of analysis, irrational numbers were introduced to *complete* intervals of rationals, and the immeasurables are introduced for the same purpose. Immeasurables complete the disconnected neighborhoods of infinity in the way that irrationals complete the disconnected rationals [2].

If the various piecewise χ_{\pm}^4 and χ_{\emptyset}^4 are concatenated to make a smooth curve from \mathcal{H}_k to \mathcal{H}_{k+1} in one affine parameter, call it χ^4 , then the location of \emptyset along that curve is given by some $\chi^4 \in \mathbb{F}$, as in Figure 6 (Section 1.6.2). In other words, if the neighborhood of χ^4 around \mathcal{H}_k is parameterized as $\mathbb{R}^{\mathcal{X}}$, then the higher level of aleph on the far side of \emptyset is a neighborhood of greater fractional distance $\mathbb{R}^{\mathcal{Y}}$ such that $\mathcal{Y} > \mathcal{X}$. $\mathbb{R}^{\mathcal{X}}$ spans the interval of χ^4 on one level of aleph, and $\mathbb{R}^{\mathcal{Y}}$ spans it on the next level (Figure 6). In the χ^4 parameterization of the path between two \mathcal{H} -branes, \emptyset becomes a topological obstruction because $\chi^4 \in \mathbb{F}$ is a non-arithmetic number.¹ Arithmetic is not defined in the usual way for such numbers, and the value $\chi^4 = \mathcal{F}_{\mathcal{X}}$ is a hard-coded topological boundary condition. Waves that time evolve in χ^4 cannot be simply transmitted through $\chi^4 = \mathcal{F}_{\mathcal{X}}$. In this way, \emptyset is similar to the topological obstruction at \mathcal{H} . \mathcal{H} and \emptyset must function as topological obstructions to separate the KK theories in Σ^{\pm} . Recall that the MCM introduces two disconnected 5D metrics, each containing an EM potential 4-vector and a dual 4-vector. The extra pair of potential vectors is meant to avoid a requirement of KKT that all solutions must be ones in which the EM field strength tensor vanishes. The MCM workaround requires the mutual topological isolation of Σ^{\pm} . This is achieved with \mathcal{H} placed at undefined $\chi_{\pm}^4 = 0$ and \emptyset placed at some $\mathcal{F}_{\mathcal{X}} \in \mathbb{F}$ for which normal arithmetic is not defined.

It has been supposed that the topological discrepancy between the Σ^{\pm} metric signatures might be assigned to a phase acquired in a process akin to specular optical reflection from a singularity at \emptyset [72]. Phase shifted optical reflection would be associated with gravitational transmission through a black hole/white hole pair in the \emptyset -brane.² Overall, the manner of forward connection from Σ^+ to Σ^- is prominent among the unresolved issues in the MCM, and in fractional distance analysis. To wit, it was not uniquely determined in [2] whether \mathbb{F} is a set of disconnected points or disconnected intervals. It was assumed for simplicity that the $\mathcal{F}_{\mathcal{X}}$ are single numbers, but they may be intervals of numbers. In an *exactly* congruent problem, the MCM has not yet determined whether \mathcal{A} and Ω are separated by an interval, a point, or if their union is the object that we have labeled \emptyset .³ Referring again to Figure 6, the thinking

¹Non-arithmetic numbers are motivated, defined, and discussed in Section 7.5 of [2].

²In the physical metric, \emptyset will be associated with the high curvature limits of de Sitter and anti-de Sitter space and must, therefore, be a topological singularity in the physical coordinates with infinite curvature or curvature in the neighborhood of infinity.

³In the convention where the union of \mathcal{A} and Ω is identified with \emptyset , these branes would become unincluded boundaries of Σ^{\pm} .

that branes should not mutually gravitate suggests that \mathcal{A} and Ω should lie at (or in) \mathcal{F}_λ relative to \mathcal{H} , but it is not determined if an interval should separate them. Such open questions regarding Ω , \emptyset , and \mathcal{A} are treated independently in Section 4.

Strong congruence between fractional distance analysis and the MCM is further evidence that the latter is physically robust. In pure mathematical analysis [2], a paradox was suggested such that there should exist a least positive real number, or a least real number greater than another real number [2]. In the arena of physics, there is no such paradox because the absence of an absolute origin makes it impossible for an observer to compute physically meaningful *absolute* distance fractions. The absence of any absolute reference frame has been known at least since the time of Galileo. (Coordinate transformations between arbitrary origins of coordinates are called *Galilean* transformations.) The lack of any absolute reference frame is integral to Einstein's theory of relativistic Lorentz transformations as well. Even questions about Mach's principle that escape description in GR refer to the same lack of an absolute reference frame [78]. Furthermore, the mathematical analysis of fractional distance in [2] left an open question regarding whether successive neighborhoods of fractional distance are separated by single numbers or intervals of numbers. This question is mirrored perfectly in the issue of the forward connection of Σ^+ to Σ^- on a higher level of aleph. The main qualitative issues raised in the physical analysis were the main quantitative issues discovered in the mathematical analysis. This identical overlap between physics and an only-tangentially related exercise in real analysis is good evidence that the MCM is a robust physical theory. The prior precedent of uncanny historical overlap between physics and analysis is good evidence that \hat{M}^3 can be formalized at the level suggested in this paper.

1.6.7 The Big Exponential Function

Quantum states are most often represented as sums of exponential functions. The following modification to the exponential function was posed as an analytical structure on which one might differentiate representations of $|\psi; \hat{\pi}^k\rangle$ and $|\psi; \hat{\pi}^j\rangle$ when $j \neq k$. There is no such ready structure in the usual expression for the exponential function. In [71], we posed

$$e^{ikx} = \sum_{n=0}^{\aleph} \frac{(ikx)^n}{n!} = \sum_0^{\aleph_0} \frac{(ikx)^n}{n!} + \sum_{\aleph_0}^{\aleph_\infty} \frac{(ikx)^n}{n!} + \sum_{\aleph_\infty}^{\aleph_{\infty\infty}} \frac{(ikx)^n}{n!} + \dots \quad , \quad (1.6.20)$$

where each sum over aleph pertains to a level of aleph. This early modification to e^x has been formalized subsequently as **the big exponential function** E^x [2], and,

in the current notation, e^x retains its usual meaning as a sum over $n \in \mathbb{N}$. Fractional distance is such that every natural number belongs to the neighborhood of the origin, so it was supposed that the infinite sum in the exponential function might be expanded as E^x to include more than a natural number of terms. Given $\mathbb{N}_0 \equiv \mathbb{N} \subset \mathbb{R}^0$, we define a new set \mathbb{N}_∞ consisting of the natural numbers and their analogues in every neighborhood of fractional distance. Using \mathbb{N}_∞ , the big exponential function is

$$E^{ikx} = \sum_{n \in \mathbb{N}_\infty} \frac{(ikx)^n}{n!} = \sum_{n \in \mathbb{N}_0} \frac{(ikx)^n}{n!} + \sum_{n \in \mathbb{N}_{\mathcal{X}_1}} \frac{(ikx)^n}{n!} + \sum_{n \in \mathbb{N}_{\mathcal{X}_2}} \frac{(ikx)^n}{n!} + \dots \quad (1.6.21)$$

By the property

$$\left. \begin{array}{l} x \in \mathbb{R}^0 \\ y \in \mathbb{R}^{\mathcal{Y}} \\ \mathcal{Y} > 0 \end{array} \right\} \implies \frac{x}{y} = 0 \quad , \quad (1.6.22)$$

given in [2], it follows that kx in the neighborhood of the origin implies that all but the first sum on the right side of (1.6.20) will vanish. In (1.6.21), the sums over $n \notin \mathbb{N}_0$ vanish for the same reason when $kx \in \mathbb{R}^0$. It is proven in [2] (Theorem 6.2.5) that $E^x = e^x$ when $x \in \mathbb{R}^0$, but the big exponential function is not identically equal to e^x when $kx \notin \mathbb{R}^0$. Along with the new rules for arithmetic in the neighborhood of infinity [2], this function provides a tool for new methods in physics.

Spacelike and timelike coordinate separations often appear in the argument of the exponential function. The expression $\exp\{i[\mathbf{k} \cdot (\mathbf{x}_2 - \mathbf{x}_1) - \omega(t_2 - t_1)]\}$ is common enough. Therefore, one utility for E^x should be for the specification of wavefunctions on different levels of aleph such that $\Delta \mathbf{x}$ and Δt , or their chirological analogues, should be quantities with non-vanishing fractional distance. Given a wavefunction $|\psi, \hat{\pi}^n\rangle$, the $\hat{\pi}^n$ object might act as a window function—a Kronecker δ analogue—selecting only the sum over the $\mathbb{N}_{\mathcal{X}}$ corresponding to the n^{th} level of aleph. In a normalized convention such that the observer always sees himself on $\hat{\pi}^0 = \hat{1}$, the big exponential function will always reduce to the regular exponential function if $\Delta \mathbf{x}, \Delta t \in \mathbb{R}^0$. This will always be the case for physics confined to \mathcal{H} . However, the MCM seeks to expand the realm of physics beyond \mathcal{H} , and beyond the local level of aleph. It is hoped that certain quantum effects may be attributed to tunneling or interference effects across levels of aleph. The big exponential function is purposed as a scaffold on which to develop analytical statements of such effects. Other use cases for levels of aleph via the big exponential function include the following.

- All methods for anharmonic potentials in QFT rely on series decompositions of

integrals of exponential functions. Decomposition by big rather than little exponential functions may be a useful tool for tackling problems which are currently perceived as intractable.

- The Feynman rules for constructing amplitudes from diagrams might be altered so that a diagram's elements pertain to levels of aleph. In some intuitive way, one would associate QED's enumerated loop corrections with levels of aleph leading to an enhanced understanding of the theory.
- Quantum theory's well-known perturbative powers series in the fine structure constant may be better interpreted as contributions from different levels of aleph. Each α^n term in a power series would come from the $\hat{\pi}^{\pm n}$ levels measured relative to the observer's location on $\hat{\pi}^0$.
- Levels of aleph were integral to solving the Riemann hypothesis. The architecture [49] of the later direct contradictions [2, 47, 48, 79] was totally reliant on *odd and even levels of aleph*. In the picture described by Figure 6, the even levels of aleph are the coordinate systems attached to \mathcal{H}_k . The odd levels refer to another coordinate systems whose origin is in \emptyset . The latter would be used to stitch together the even levels, as in Section 1.6.8.
- Though levels of aleph were not cited in computing the characteristic length scale 10^{-4}m (Section 15) [3], the general idea was that contributions from other levels of aleph would alter the expected $F_{\text{net}}\hat{z} = \vec{0}$ balance of Newtonian forces for a spinning disc in \mathcal{H}_0 .

1.6.8 A Practical Implementation of Transfinite Numbers

The lack of arithmetic for non-arithmetic numbers makes any parameterization of the unit cell including such numbers inherently cumbersome. Since the observer has no way to measure absolute fractional distance, and since coordinates should always be chosen to simplify physics as much as possible, one would seek a parameterization of the path between successive \mathcal{H} -branes which does not rely on $x \in \mathbb{F}$. Rather than parameterizing the total extent of χ^4 in one simply connected interval of \mathbb{R} (up to a complex phase), we may use the transfinite continuation of \mathbb{R} , call it \mathbb{T} , and a piecewise connected parameter. (The transfinitely continued real number line \mathbb{T} follows from the definitions of $\{\mathbb{R}^0, \mathbb{R}^{\mathcal{X}}, \mathbb{R}^1\}$ extended to the case of $\mathcal{X} > 1$.) In the suggested transfinite parameterization, \emptyset lies at $\widehat{\infty}$ relative to an origin in \mathcal{H}_k , and sequential \mathcal{H} -branes are separated by two levels of aleph. If we assume for simplicity that Ω and \mathcal{A} are colocated at \emptyset , \mathcal{H}_{k+2} lies at $2\widehat{\infty}$, etc. The scheme by which one

would execute the parameterization as $\chi^4 \in \mathbb{T}$ is outlined in Figures 7-9. The bulk of successive Σ^\pm will be doubly charted in coordinates whose origins are in the successive bounding branes. Following an example from real analysis in which the 2-sphere is covered by a double charting of coordinates whose origins are at its two opposite poles, coordinates anchored in \mathcal{H}_0 in the form $\chi_{+\{0\}}^4 = \widehat{0} + b$ stretch nearly to Ω .¹ (The subscript $\{k\}$ on $\chi_{\pm\{k\}}^4$ labels the level of aleph.) \mathcal{F}_0 is the least upper bound of $\mathbb{R}^0 = \{x \mid \widehat{0} + b \text{ for } |b| < n \in \mathbb{N}\}$, so we say the $\widehat{0} + b$ chart stretches *nearly* to Ω located at $\chi^4 = \mathcal{F}_0$ in the simply connected parameter. Similarly, coordinates measured relative to Ω in the form $\chi_{+\{1\}}^4 = \widehat{\infty} - b$ will stretch nearly back to \mathcal{H}_0 . If Ω and \mathcal{A} are colocated, then the coordinates anchored at $\mathcal{A} \cup \Omega \equiv \emptyset$ will also stretch almost to \mathcal{H}_2 as $\chi_{-\{1\}}^4 = \widehat{\infty} + b$. In terms of χ_\emptyset^4 coordinates, we would write

$$\chi_{+\{1\}}^4 \cup \chi_{-\{1\}}^4 = \chi_{\emptyset\{1\}}^4 \quad . \quad (1.6.23)$$

The $\chi_{-\{1\}}^4$ will overlap with $\chi_{-\{2\}}^4 = 2\widehat{\infty} - b$, and so on. The $\chi_{\emptyset\{k+1\}}^4$ on odd levels of aleph will double chart the Σ^\pm spanned by $\chi_{+\{k\}}^4$ and $\chi_{-\{k+2\}}^4$. This scheme for double charting between the neighborhood of the origin and the maximal neighborhood infinity makes it possible for us to avoid any reference to the \mathcal{F}_χ numbers for which normal arithmetic is not defined.

Contrary to the lack of arithmetic defined for $x \in \mathbb{F}$, we have already defined a complete system of transfinite arithmetic for $x = n\widehat{\infty}$ when $n \in \mathbb{N}$ [2]. The transfinite continuation should permit a representation of the translation of an observer's reference frame onto a higher level of aleph as nothing but a Galilean transformation (up to a change of scale.) After operating with \widehat{M}^3 to leave the $\chi_{\pm\{0\}}^4 = \widehat{0} \pm b$ coordinates and arrive in the $\chi_{\pm\{1\}}^4 = 2\widehat{\infty} \pm b$ coordinates, a coordinate system in the form $\chi_{\{1\}}^4 = \widehat{0} \pm b$ is easily recovered by subtracting $2\widehat{\infty}$.² Furthermore, this scheme for $\chi^4 \in \mathbb{T}$ restores the original notion of odd and even levels of aleph [1, 49]. To distinguish odd and even levels of aleph, namely, conventions would be amended such that \emptyset is one level higher than \mathcal{H}_0 and the forward \mathcal{H} -brane is two levels higher. This is intuitive when the coordinates on the $\hat{\pi}^n$ level of aleph are such that $\chi_{\{n\}}^4 = n\widehat{\infty} \pm b$. The oddness or evenness of the level of aleph is that of the iterator n .

¹The hat on $\widehat{0}$ is a convenient notation demonstrating that one may measure distance relative to any origin of coordinates. It is a convention to place zero at the origin, but one may measure relative to any other number, such as $\widehat{\infty}$.

²Using numbers in the neighborhood of infinity, this section necessarily describes *physical* parameterizations along χ^4 . The abstract coordinates are introduced so that we may describe distances along χ^4 with numbers in the neighborhood of the origin. So, to the extent that we have suggested that infinite relative scale between unit cells should be encoded on the k quantum number in $|\psi; \hat{\pi}^k\rangle$, the Galilean transformation subtracting $2\widehat{\infty}$ might be associated with subtracting 2π in the abstract coordinates. This might be further associated with the 2π in \widehat{M}^3 's returned value $2\pi\Phi$.

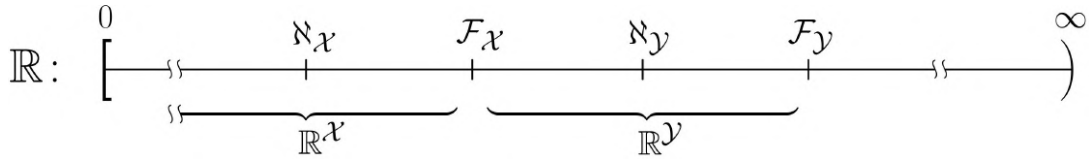

Figure 7: This figure shows the structure of \mathbb{R} as developed in [2]. (The negative branch of \mathbb{R} is omitted.) Due to the lack of standard arithmetic operations for $\mathcal{F}_x \in \mathbb{F}$, it is desirable that the path between successive \mathcal{H} -branes should be parameterized without reference to \mathcal{F}_x .

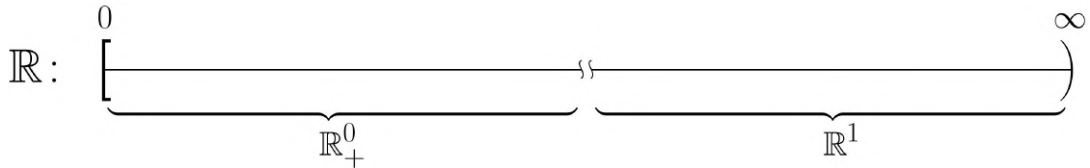

Figure 8: This figure shows the real number line separated between the neighborhood of the origin \mathbb{R}^0 and the maximal neighborhood of infinity \mathbb{R}^1 . Relating to the objects of Figure 7, the neighborhood of the origin \mathbb{R}^0 terminates at \mathcal{F}_0 . Since it is not possible to do arithmetic with non-arithmetic numbers such as \mathcal{F}_0 [2], we should introduce a coordinate chart that does not reference them. We propose to introduce a coordinate transformation such that, for instance, every $x = b \in \mathbb{R}^0$ is associated with some $x' = (\widehat{\infty} - b) \in \mathbb{R}^1$, as in Figure 9.

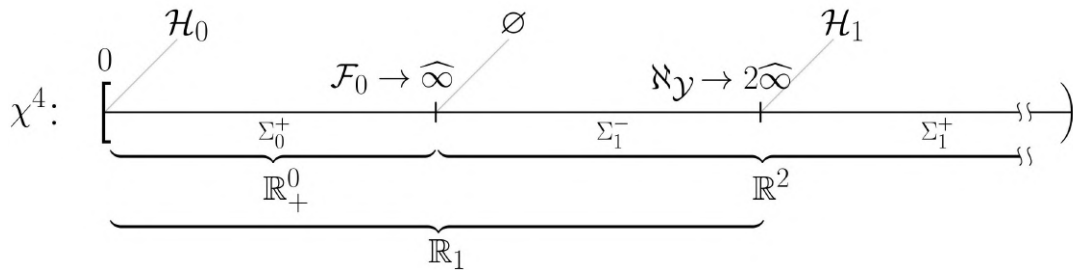

Figure 9: Even levels of aleph are sewn together with odd levels, and vice versa, as in [49]. The midpoint of the least intermediate neighborhood of fractional distance is labeled \aleph_y . In the scheme where Ω and \mathcal{A} are colocated with \emptyset , an intractable $\chi^4 = \mathcal{F}_0$ at the $\Sigma^+ \rightarrow \Sigma^-$ step of \hat{M}^3 is made tractable by a coordinate transformation in which $\mathcal{F}_0 \rightarrow \widehat{\infty}$. Arithmetic, and by extension calculus, is well defined for $\widehat{\infty}$. It is proposed that the 5D bulk of Σ_0^+ should be doubly charted in \mathbb{R}^0 and \mathbb{R}^1 so that no reference is made to any $x \in \mathbb{F}$ during $\mathcal{H} \rightarrow \mathcal{H}$ evolution under \hat{M}^3 . In this figure's parameterization such that $\chi^4 \in \mathbb{T}$, the non-arithmetic \mathcal{F}_x are replaced by odd integer multiples of $\widehat{\infty}$, and all \aleph_x are replaced by even integer multiples.

Going *beyond infinity* is not allowed in real analysis, but neither is going onto the complex plane, and that is standard in physics. Going beyond infinity into \mathbb{T} is only the longitudinal continuation of \mathbb{R} in the way that going onto \mathbb{C} is the transverse continuation. All the tools of complex analysis have the highest utility in physics, and we suggest that any tools developed in the transfinite analysis of fractional distance are likely to be equally useful for physics.

1.6.9 Further Considerations for Even and Odd Levels of Aleph

Consider the limit of \aleph_x as x goes to 0. For any $x > 0$, this number has non-vanishing fractional distance and must be greater than any $n \in \mathbb{N}$. From this we conclude

$$\lim_{x \rightarrow 0} \aleph_x \neq 0 \quad . \quad (1.6.24)$$

Since \mathcal{F}_0 is defined to be the least real number greater than every natural number, a reasonable supposition is

$$\lim_{x \rightarrow 0} \aleph_x = \mathcal{F}_0 \quad . \quad (1.6.25)$$

If we were to take $\aleph_0 = \mathcal{F}_0$ rather than the stated $\aleph_0 = 0$, then every other $\mathcal{F}_\mathcal{X}$ should also be some $\aleph_\mathcal{X}$. Thus, we might suppose that the piecewise double charting suggested in Figure 9 is naturally as in Figure 10. However, the double charting of intervals in two simultaneous neighborhoods of infinity $\mathbb{R}^\mathcal{X} \neq \mathbb{R}^\mathcal{Y}$ is such that

$$x \in \mathbb{R}^\mathcal{X}, \mathbb{R}^\mathcal{Y} \quad \implies \quad \frac{x}{\infty} = \mathcal{X} \quad , \quad \text{and} \quad \frac{x}{\infty} = \mathcal{Y} \quad . \quad (1.6.26)$$

To resolve this contradiction, we might assign $\mathbb{R}^\mathcal{Y}$ as an odd level of aleph and say that all *odd* $\{\aleph_\mathcal{Y}\}$ are the immeasurable $\mathcal{F}_\mathcal{X} \in \mathbb{F}$. In this convention, the neighborhoods of fractional distance associated with successive \mathcal{H} -branes are even levels. The non-arithmetic property would be associated to the separation of \mathcal{X} and \mathcal{Y} by a hypothetical least positive real number as

$$|\mathcal{Y} - \mathcal{X}| = \text{undefined} \quad . \quad (1.6.27)$$

However, the Cauchy sequences definition of \mathbb{R} [2] might suggest that $|\mathcal{Y} - \mathcal{X}| = 0$, so further analysis is required. The non-arithmetic, odd neighborhoods of fractional distance would be distinguished from the open, even neighborhoods by topological closure. We will not use this convention in the present book. It is mentioned mainly because $\aleph_0 = 0$ was given in the main paper on fractional distance analysis [2] while that equality may not be supported by the ε - δ formalism, and because $\aleph_0 = \mathcal{F}_0$ supports a desirable construction for even and odd levels of aleph.

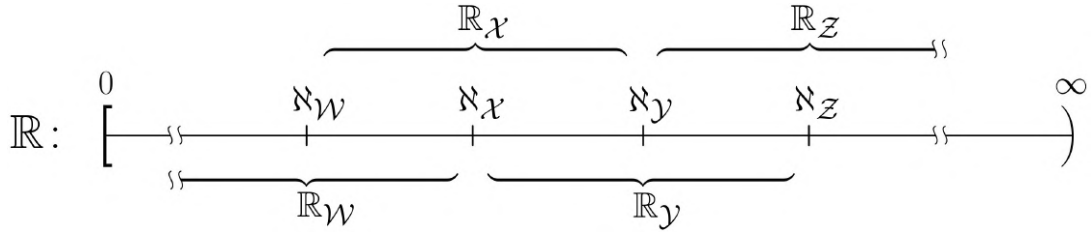

Figure 10: Compare this figure to Figures 7 and 9. In this scheme, odd levels of aleph are associated with immeasurable numbers. The connectedness of \mathbb{R} would require that odd neighborhoods are topologically closed because the even neighborhoods are open.

As a consequence of this scheme for odd and even levels of aleph, one might suppose that the non-definition of $\chi_{\pm}^4 = 0$ is better characterized by the location of the \mathcal{H} -brane at a non-arithmetic value of χ^4 in the reversed convention for choosing even and odd.

1.7 Operators, States, and the Schrödinger Equation

1.7.1 \hat{M}^3 as a Translation Operator

The usual quantum theory implements time evolution between measurements as diffusion (or oscillation) followed by collapse. The MCM supplements the usual theory of successive measurements in \mathcal{H} with intermediate steps at Ω and \mathcal{A} . Therefore, given $\hat{M}^3 = \prod_{\lambda} \hat{M}_{\lambda}$, one might take \hat{M}_{λ} as an ordinary translation operator $\hat{\mathcal{J}}_{\lambda}$ such that we would have the following for $\lambda \in \{+, -, \emptyset\}$:

$$\hat{M}_{\lambda} \equiv \hat{\mathcal{J}}_{\lambda}(\Delta\chi_{\lambda}^4) = c_{\lambda} \exp\left\{-\frac{i\hat{p}_{\lambda}\Delta\chi_{\lambda}^4}{\hbar}\right\}, \quad \text{with} \quad \hat{p}_{\lambda} = -i\hbar\partial_{\lambda}. \quad (1.7.1)$$

(See Appendix B for a review of the translation operator $\hat{\mathcal{J}}$.) In this way, \hat{M}^3 would send states across the unit cell as

$$\begin{aligned} \hat{M}^3|\psi, \hat{\pi}^0\rangle &= \hat{\mathcal{J}}_- \hat{\mathcal{J}}_{\emptyset} \hat{\mathcal{J}}_+ |\psi; \hat{\pi}^0\rangle \\ &= \pi \hat{\mathcal{J}}_- \hat{\mathcal{J}}_{\emptyset} |\psi; \hat{\Phi}^0\rangle \\ &= \Phi\pi \hat{\mathcal{J}}_- |\psi; \hat{2}^1\rangle \\ &= 2\pi\Phi |\psi; \hat{\pi}^1\rangle. \end{aligned} \quad (1.7.2)$$

There are a number of problems with this definition for \hat{M}^3 . These deficiencies provide guidance toward a better analytical representation.

- The unit cell is such that for \mathcal{H} located at $\lim \chi_{\pm}^4 \rightarrow 0$, we have \mathcal{A} at $\chi_-^4 = -\varphi$ and Ω at $\chi_+^4 = \Phi$. This allows us to define appropriate $\hat{\mathcal{J}}_{\lambda}$ with $\Delta\chi_+^4 = \Phi$ and $\Delta\chi_-^4 = \varphi$. (The latter is supplemented by an understanding that $\Delta\chi_-^4$ is defined according to the scale of the forward level of aleph, and that it must increase in the opposite direction to χ_+^4 .) However, the step $\Omega \rightarrow \mathcal{A}$ may be more like a time reversal or a reflection than a translation operation. If Ω is a black hole and \mathcal{A} is a white hole connected by a zero distance wormhole (the case in which Ω and \mathcal{A} are colocated at \emptyset rather than bounding a region containing it), a reversal of the time arrow may be all that is needed to execute $\Omega \rightarrow \mathcal{A}$. However, it is not yet determined whether \mathcal{A} and Ω bound the region containing \emptyset , or if they are colocated there. (These cases are discussed in Section 4.) So, it is not clear that the $\Omega \rightarrow \mathcal{A}$ step involves any translation at all. If it does, simple translation cannot tell the whole story because the metric signature changes between Σ^{\pm} . Waves (or heatlike solutions) cannot be simply transmitted through the obstruction in the topology induced by the changing metric signature.
- With subscripts running over $\{+, -, \emptyset\}$, one would assume $[\hat{p}_j, \hat{p}_k] = 0$ and, consequently, $[\hat{M}_j, \hat{M}_k] = 0$. If these operators commute, then we should be able to reorder them, but that is not consistent with the overall idea. For instance, the \hat{M}_2 operator executing $\Omega \rightarrow \mathcal{A}$ should only act on states in Ω . It may not make sense for it to act on other states.
- $\hat{\mathcal{J}}$ executes equal-time parallel transport. Since observation B necessarily takes place at some chronological time later than that associated with observation A , the translation operator alone is not sufficient to accomplish the evolution. The state $\hat{M}^3|\psi; \hat{\pi}^n\rangle = c|\psi; \hat{\pi}^{n+1}\rangle$ must show up in \mathcal{H}_{n+1} with a time that agrees with $\hat{\mathcal{U}}(t_{n+1}, t_n)|\psi, t_n\rangle = |\psi, t_{n+1}\rangle$. In other words, MCM time evolution must incorporate Schrödinger evolution as a simultaneous process during a transit of the unit cell. Static transport by $\hat{M} \propto \hat{\mathcal{J}}$ cannot agree with time-dependent experimental results.

1.7.2 \hat{M}^3 as a Ladder Operator

\hat{M}^3 is like a ladder operator for the level of aleph. It increases the k quantum number when it operates on $|\psi, \hat{\pi}^k\rangle$. To better understand \hat{M}^3 and its associated constant $2\pi\Phi$, we will look at the Dirac ladder operators

$$\hat{a}^\dagger = \sqrt{\frac{m\omega}{2\hbar}} \left(\hat{x} - \frac{i\hat{p}}{m\omega} \right) , \quad \text{and} \quad \hat{a} = \sqrt{\frac{m\omega}{2\hbar}} \left(\hat{x} + \frac{i\hat{p}}{m\omega} \right) . \quad (1.7.3)$$

They raise and lower the n quantum number for states in the simple harmonic oscillator (SHO) potential. Such states are denoted $|n\rangle$. Dirac notation is such that

$$\hat{a}^\dagger|n\rangle = \sqrt{n+1}|n+1\rangle \quad , \quad \text{and} \quad \hat{a}|n\rangle = \sqrt{n}|n-1\rangle \quad . \quad (1.7.4)$$

So far, however, we have treated \hat{M}^3 only in the Dirac notation

$$\hat{M}^3|\psi; \hat{\pi}^n\rangle = 2\pi\Phi|\psi; \hat{\pi}^{n+1}\rangle \quad , \quad (1.7.5)$$

without first writing down its analytical expression, as in (1.7.3). Namely, (1.7.4) is only a shorthand developed after Schrödinger's equation was solved for the SHO Hamiltonian

$$\hat{H} = \frac{\hat{p}^2}{2m} + \frac{m\omega^2\hat{x}^2}{2} \quad , \quad \text{with} \quad \omega = \sqrt{\frac{k}{m}} \quad . \quad (1.7.6)$$

The solution is

$$|n\rangle = \phi_n(x) = \frac{1}{\pi^{1/4}(2^n n!)^{1/2}} H_n(x) e^{-x^2/2} \quad , \quad (1.7.7)$$

where H_n is the n^{th} Hermite polynomial. This result shows that the real physics of (1.7.4) comes from (1.7.7) and (1.7.3). Operation with \hat{a} and \hat{a}^\dagger on $\phi_n(x)$ *provably* yields $\hat{a}^\dagger|n\rangle = \sqrt{n+1}|n+1\rangle$ and $\hat{a}|n\rangle = \sqrt{n}|n-1\rangle$. For \hat{M}^3 , we have jumped into the end result of the operator algebra $\hat{M}^3|\psi; \hat{\pi}^n\rangle = 2\pi\Phi|\psi; \hat{\pi}^{n+1}\rangle$ without first finding the analytical representation of \hat{M}^3 . On top of that, we have suggested that a more complicated equation than Schrödinger's equation is needed for \hat{M}^3 without writing that equation down and solving for its states. For example, SHO states are such that

$$|n\rangle = \frac{1}{\sqrt{n!}} (\hat{a}^\dagger)^n |0\rangle \quad , \quad (1.7.8)$$

but we have not yet found an analytical form for \hat{M}^3 with which to *provably* write

$$|\psi; \hat{\pi}^n\rangle = c_n (\hat{M}^3)^n |\psi; \hat{\pi}^0\rangle \quad . \quad (1.7.9)$$

Even if we did have the analytical form of \hat{M}^3 , all we know about $|\psi; \hat{\pi}^0\rangle$ is that it must reduce to the corresponding quantum mechanical $|\psi\rangle$ in the limit of $\chi_\pm^4 \rightarrow 0$. That may or may not be a trivial constraint. As SHO states are uniquely determined from the SHO Hamiltonian and Schrödinger's equation *jointly*, MCM analogues of these important fundamentals are required.

Regarding the discovery of the Schrödinger equation, Schrödinger deduced it (or guessed it) following a process of trial and error [80, 81]. He was well directed in his

search by an understanding that the equation for the wavefunction should be first order in its time derivative, but the MCM has two kinds of time, and the expected equation for \hat{M}^3 should be third order in at least one of them. Thus, a potential iterative development process searching for the MCM equation may be far more cumbersome than Schrödinger's search for his eponymous complex heat equation. Luckily, we will observe in Section 1.11 that certain results suggest a narrowing of the field of all possible equations for \hat{M}^3 .

1.7.3 MCM Plane Wave States

Kaluza–Klein theory requires that there should not exist any 5D matter-energy in the bulk of Σ^\pm . This suggests that we should treat the bulk as free space devoid of any potential energy landscape. The Hamiltonian operator for free space in one dimension is

$$\hat{H}_0 = -\frac{\hbar^2}{2m}\partial_x^2 \quad , \quad (1.7.10)$$

and the solutions to the according Schrödinger's equation are plane waves:

$$\phi(x, t) = \exp\{i[kx - \omega(k)t]\} \quad , \quad \text{with} \quad \omega(k) = \frac{\hbar k^2}{2m} \quad . \quad (1.7.11)$$

In the position representation, infinite plane waves are momentum eigenstates. Free momentum eigenstates cannot be observed, so, referring to the rigged Hilbert space $\{\mathcal{H}', \mathcal{A}', \Omega'\}$, infinite plane waves cannot live in \mathcal{A}' , which is ordinary Hilbert space. On the other hand, plane waves in a finite region V are constrained by $\phi'(\partial V) = 0$, where ∂V is the boundary of V . Subject to this boundary condition, ϕ' is normalizable and can belong to \mathcal{A}' .

The main utility of infinite plane waves is for the construction of wavepackets which are normalizable and observable, even in unbounded regions:

$$u(x, t) = \frac{1}{\sqrt{2\pi}} \int_{-\infty}^{\infty} dk A(k) \underbrace{\exp\{i[kx - \omega(k)t]\}}_{\phi(x, t)} \quad \implies \quad u \in \mathcal{A}' \quad . \quad (1.7.12)$$

The infinite plane waves in the integrand are Fourier transforms of Dirac δ functions. Such functions and their Fourier transforms, two representations of the same state, only live in Ω' . So, since plane waves (i) satisfy the Schrödinger equation, (ii) are the analytical basis for all-important wavepackets, and (iii) they appeal to the small sliver of extra freedom afforded by the Ω' part of the MCM's rigged Hilbert space, ϕ is an appropriate state for the presumed energy landscape between two instances of \mathcal{H} . The search for \hat{M}^3 's equation should begin with \hat{M}^3 acting on plane waves.

The new equation should contain non-vanishing derivatives with respect to χ^4 , so the ansatz for an MCM plane wave will be

$$\psi(x, t, \chi_{\pm}^4) = \exp\{i(kx - \omega t \pm \chi_{\pm}^4)\} \quad ,^1 \quad (1.7.13)$$

where χ_{\pm}^4 includes an implicit χ_{\emptyset}^4 case, if needed. Appealing to χ^4 as a non-physical, abstract coordinate, we will assume it is dimensionless and does not require an analogue of k or ω .² $\psi(x, t, \chi_{\pm}^4)$ reduces to the QM wavefunction $\phi(x, t)$ in the $\chi_{\pm}^4 \rightarrow 0$ limit corresponding to \mathcal{H} . This limiting behavior is a hard constraint on the theory since QM is known to agree with experiment. As per usual in physics, one starts with a boundary condition and then develops solutions accordingly. The present boundary condition is that an MCM plane wave in the bulk must reduce to an ordinary plane wave in \mathcal{H} .

Landau's treatment of plane waves is demonstrative [82].

“A plane wave is a mathematical abstraction, a solution to the wave equation which has constant phase along a 2D infinite plane. Although these may not be physically realizable, they are a convenient substitute for a wave packet of definite momentum and are the conventional basis for expanding the wave function of an interacting particle. The wave functions of quantum mechanics form a Hilbert space, that is, a linear vector space of infinite dimension. Whereas the dynamical coordinates \mathbf{r} and \mathbf{p} of wave functions are continuous, the eigenvalues or parameters of these functions, such as the bound-state energies $E = -\kappa_i^2/2\mu$ are discrete. Any Hermitian Hamiltonian can be used to generate a complete, orthogonal set of wave functions. The free-particle Hamiltonian,

$$H_0 = \frac{\mathbf{p}^2}{2\mu} = -\frac{\nabla^2}{2\mu} \quad , \quad (1.7.14)$$

is particularly convenient because it generates the plane waves:

$$\begin{aligned} \tilde{\mathbf{p}}\phi_{\mathbf{k}}(\mathbf{r}) &= \mathbf{k}\phi_{\mathbf{k}}(\mathbf{r}) \quad , & k &= |\mathbf{k}| \\ H_0\phi_{\mathbf{k}} &= E_k\phi_{\mathbf{k}}(\mathbf{r}) \quad , & E_k &= k^2/2\mu \\ \phi_{\mathbf{k}}(\mathbf{r}) &= Ne^{i\mathbf{k}\cdot\mathbf{r}} \quad , & N &= \begin{cases} (2\pi)^{-3/2} & \text{infinite domain} \quad , \\ V^{-1/2} & \text{finite domain} \quad . \end{cases} \end{aligned} \quad (1.7.15)$$

¹For simplicity, we intermingle physical and abstract coordinates in (1.7.13).

²As MCM plane waves are developed, we will choose to include a coefficient as a scale factor for χ^4 . The coefficient will be sufficient to accommodate its dimensionless and dimensionful cases.

For simplicity in developing the formalism (and a patina of mathematical rigor), it is useful to consider the plane waves as occupying a finite volume (a box). The box and the periodic boundary conditions we impose on the wave functions are just for convenience (scattered waves are certainly not periodic); eventually we will go to the limit of an infinite domain.

“Little Boxes

“To determine the allowed eigenenergies, we place the plane waves $[\phi_{\mathbf{k}}(\mathbf{r})]$ in a box of volume V with sides (L_x, L_y, L_z) , and demand that they satisfy the periodic boundary conditions

$$\begin{aligned} \phi_{\mathbf{k}}(x + L_x, y + L_y, z + L_z) &= \phi_{\mathbf{k}}(x, y, z) \quad , & (1.7.16) \\ \implies (k_x L_x, k_y L_y, k_z L_z) &= 2\pi(i_x, i_y, i_z) \quad . \end{aligned}$$

Here $(i_x, i_y, i_z) \equiv i$ is a set of three positive or negative integers which determine the allowed, discrete wave vectors and thus energies:

$$\mathbf{k}_i = 2\pi \left(\frac{i_x}{L_x}, \frac{i_y}{L_y}, \frac{i_z}{L_z} \right) \quad , \quad E_i = \frac{k_i^2}{2\mu} \quad . \quad (1.7.17)$$

With these boundary conditions, the plane waves for different values of i and j are *orthogonal*. By choosing the normalization constant N we make the plane waves *orthonormal*:

$$\begin{aligned} \phi_{\mathbf{k}_i}(\mathbf{r}) \equiv \phi_i(\mathbf{r}) &= \frac{e^{i\mathbf{k}_i \cdot \mathbf{r}}}{\sqrt{V}} \quad , & (1.7.18) \\ \implies \int d^3r \phi_i^*(\mathbf{r}) \phi_j(\mathbf{r}) &= \delta_{ij} \quad , & (\text{orthonormality}) \quad . \end{aligned}$$

Note that in the confined volume of the box, the variable \mathbf{k} is discrete but the variable \mathbf{r} is continuous (but limited.) The discreteness of \mathbf{k}_i leads to the *Kronecker delta function* in [(1.7.18)]. Since the free Hamiltonian is Hermitian, plane waves form a *complete set* in which any solution $\psi(\mathbf{r})$ of Schrödinger’s equation can be expanded:

$$\psi(\mathbf{r}) = \sum_i^{\infty} c_i \phi_i(\mathbf{r}) \quad . \quad (1.7.19)$$

Orthonormality determines the c_i ’s (multiply [(1.7.19)] by ϕ^* and integrate

over \mathbf{r}):

$$c_i = \int d^3r' \phi_i^*(\mathbf{r}') \psi(\mathbf{r}') \quad . \quad (1.7.20)$$

If we substitute this back into [(1.7.19)] and interchange the order of integration and summation, we obtain

$$\psi(\mathbf{r}) = \int d^3r' \left[\sum_i^{\infty} \phi_i^*(\mathbf{r}') \phi_i(\mathbf{r}) \right] \psi(\mathbf{r}') \quad . \quad (1.7.21)$$

Yet because [(1.7.21)] must be an identity, we identify the term in the brackets as some kind of unit operator. This yields the *closure or completeness relation* for discrete states:

$$\sum_i^{\infty} \phi_i^*(\mathbf{r}') \phi_i(\mathbf{r}) = \delta(\mathbf{r}' - \mathbf{r}) \quad , \quad (\text{closure}) \quad . \quad (1.7.22)$$

“The Big Box

“To obtain plane waves in an infinite domain, we let the box size approach infinity. In this limit of very large L and very large i , the index i is still an integer so $\Delta i \equiv 1$.¹ The momenta \mathbf{k}_i in [(1.7.17)] remain finite but become continuous:

$$\begin{aligned} \frac{2\pi}{L_i} \Delta i &\rightarrow d\mathbf{k}_i \quad , \quad \Delta i_x \rightarrow \frac{L_x}{2\pi} d\mathbf{k}_i & (1.7.23) \\ \sum \Delta i &\rightarrow V \int \frac{d^3\mathbf{k}}{(2\pi)^3} \quad . \end{aligned}$$

“[...] To generalize the closure relation [(1.7.22)] to a big box, we insert a $\Delta i = 1$ into the sum in [(1.7.22)], and take the $L \rightarrow \infty$ limit:

$$\begin{aligned} \sum_i^{\infty} \Delta i \phi_i^*(\mathbf{r}') \phi_i(\mathbf{r}) &= \delta(\mathbf{r}' - \mathbf{r}) \quad , & (1.7.24) \\ \implies V \int \frac{d^3k}{(2\pi)^3} \frac{e^{-i\mathbf{k}\cdot\mathbf{r}'}}{\sqrt{V}} \frac{e^{i\mathbf{k}\cdot\mathbf{r}}}{\sqrt{V}} &= \delta(\mathbf{r}' - \mathbf{r}) \quad , \quad (\text{closure}) \quad .^2 \end{aligned}$$

¹This notation means that the discrete version of the differential element of i , Δi , is equal to one because that is the smallest increment of change for an integer-valued quantity.

This gives the form for plane waves in an infinite domain:

$$\phi_i(\mathbf{r}) = \frac{e^{i\mathbf{k}_i \cdot \mathbf{r}}}{\sqrt{V}} \implies \phi_{\mathbf{k}}(\mathbf{r}) = \frac{e^{i\mathbf{k} \cdot \mathbf{r}}}{(2\pi)^{3/2}} . \quad (1.7.25)$$

The orthogonality relation [(1.7.18)] for an infinite domain is now just the closure relation with a change of variable,

$$\delta_{ij} \rightarrow \int \frac{d^3r}{(2\pi)^3} e^{-i\mathbf{k}' \cdot \mathbf{r}} e^{i\mathbf{k} \cdot \mathbf{r}} = \delta(\mathbf{k}' - \mathbf{k}) \quad (\text{orthogonality}) .'' \quad (1.7.26)$$

For disambiguation with the imaginary number i , we will replace Landau's integer i with j in the following. The factor of $(2\pi)^{-3/2}$ in (1.7.25) reflects the fact that time-independent plane waves in an infinite domain are non-physical and cannot be normalized in \mathbb{R} . Instead, these states are normalized to the 3D Dirac δ function, as in (1.7.26). Since it is desired that the physical distance between branes exceeds any number in the neighborhood of the origin, the continuous \mathbf{k} , unbounded, big box case proportional to $(2\pi)^{-3/2}$ should be associated with the physical coordinates. The big box case also describes unbounded plane waves in \mathcal{H} when we take the $e^{i(kx - \omega t \pm \chi_{\pm}^4)}$ ansatz with $\chi^4 = 0$. The discrete \mathbf{k} , small box case proportional to $V^{-1/2}$ should pertain to the abstract coordinates. The convention in which \mathcal{A} and Ω are surfaces of constant $\chi_{-}^4 = -\varphi$, and $\chi_{+}^4 = \Phi$ is such that Σ^{\pm} are small boxes in the fifth direction.

Consider the orthonormalism of discrete momentum states, as in (1.7.18). The orthogonality of ϕ_{j_1} and ϕ_{j_2} when $j_1 \neq j_2$ is well suited to the orthogonality of wave-functions on different levels of aleph. It was suggested in Section 1.2.5 that the ontological basis might act as lattice vectors for a cosmological lattice in which each lattice site has its own level of aleph specified by some tuple of integers. In that picture, small box plane waves are such that states at different lattice sites are orthogonal. Lattice sites specified by integer combinations of lattice vectors $\{\hat{2}, \hat{\pi}, \hat{\Phi}, \hat{i}\}$ are enumerated with $j \equiv (j_2, j_{\pi}, j_{\Phi}, j_i)$ analogous to Landau's $i \equiv (i_x, i_y, i_z)$. One caveat, however, is that the unit cell only requires the small box condition for the χ_{\pm}^4 directions. It is not yet determined whether Σ^{\pm} should be bounded in the abstract χ_{\pm}^{μ} coordinates. One is advised that the big or small box convention will depend on the choice of coordinates, and that we have still not determined if Σ^{\pm} are bounded in the χ_{\pm}^{μ} directions (or if x_{\pm}^4 coordinates should exist at all.)

$\{\phi_j\}$ are a complete orthonormal set, but the non-unitarity of the \hat{M}^3 and/or $\hat{O}_{\hat{e}_{\mu} \rightarrow \hat{e}_{\nu}}$ operators suggest that the MCM plane wave basis $\{\psi_j\}$ ought to be orthogonal

²The Dirac δ function has inverse units to its argument: $\delta(\mathbf{r})$ has units of $[\text{m}^{-3}]$.

and *not* orthonormal. The lack of normalism follows from the relative scale between levels of aleph. If the relative scale between the \mathbb{R}^x and \mathbb{R}^y levels of aleph is \mathcal{C} , then $\text{len}(\mathbb{R}^x)/\text{len}(\mathbb{R}^y)=\mathcal{C}$. In the rescaling $\mathbf{r}\rightarrow\mathcal{C}\mathbf{r}$, the 3D wave vector and energy rescale as

$$\mathbf{k}'_j = 2\pi \left(\frac{j_x}{\mathcal{C}L_x}, \frac{j_y}{\mathcal{C}L_y}, \frac{j_z}{\mathcal{C}L_z} \right) \quad , \quad \text{and} \quad E'_j = \frac{\hbar^2 \mathbf{k}'_j{}^2}{2m} = \frac{\hbar^2 \mathbf{k}_j^2}{2m\mathcal{C}^2} = \frac{E_j}{\mathcal{C}^2} \quad .^1 \quad (1.7.27)$$

Thus, the energy changes from one lattice site to another. Noting that \hbar has units of $[kg][m^2][s^{-1}]$, the normalization of the observer's reference frame onto the level of aleph where the relative scale is \mathcal{C} may require that meters are redefined to absorb the two factors of \mathcal{C} appearing in the energy's denominator. Presuming $\mathcal{C} \geq 1$, as is the case for $\mathcal{C}=2\pi\Phi$, the energy decreases with increasing j . This is a positive result because the physical arrow of time never points towards increasing energy (in the absence of work.) This energy variation may have further applications to the MCM mechanism for dark energy discussed in Section 7. Namely, cosmological redshift is such that photons lose energy with time.

In the preceding, we have considered only some generalized χ^4 without appealing to opposite sign and/or imaginary phase between χ_{\pm}^4 . The behavior of quantum states with real and imaginary wavenumbers is known from

$$k = \frac{\sqrt{2m(E-V)}}{\hbar} \quad .^2 \quad (1.7.28)$$

The wavenumber k is real when $E > V$. It is imaginary when $E < V$. Coupled with the i in e^{ikx} , we have wave propagation in the classically allowed region where $E > V$ and exponential damping in the classically forbidden region where $E < V$. It was suggested earlier that allowing χ_{\pm}^4 to be complex will allow us to avoid the metric signature discrepancy at the $\Omega \rightarrow \mathcal{A}$ step of \hat{M}^3 , and now we will suggest an implementation by adding a wavenumber or frequency multiplier to the ansatz as

$$\psi(x, t, \chi^4) = \exp\{i(kx - \omega t + \kappa\chi^4)\} \quad , \quad \text{where} \quad \kappa = \frac{\sqrt{2m(E-V)}}{\hbar} \quad . \quad (1.7.29)$$

By choosing an appropriate energy scale on the forward level of aleph, namely $V \in \Sigma_{\{1\}}^-$ higher than $E \in \Sigma_{\{0\}}^+$, we might make the region of metric discrepancy a classically forbidden region so that κ becomes imaginary. Then we will obtain exponential

¹Compare to (1.7.17).

²This formula for the wavenumber k is standard in elementary QM problems. See Section 2.6 in [83] or Section 2.4 in [84], for example.

damping of the wavefunction in the region of metric discrepancy:

$$\psi(x, t, \chi^4) = \exp\{i(kx - \omega t + i|\kappa|\chi^4)\} = \exp\{i(kx - \omega t)\}e^{-|\kappa|\chi^4} . \quad (1.7.30)$$

Through our consideration of plane wave states, now we have come to a likely, natural resolution for the metric discrepancy between Σ^\pm . Since we would want damping to increase with penetration into Σ^- , χ^4 as in (1.7.30) has its origin in \mathcal{A} (or in \emptyset if \mathcal{A} is colocated with Ω .) The energy landscape will steer propagating waves from Σ^+ onto $i\chi^4$ spanning another instance of Σ^- where the convention for real and imaginary χ^4_\pm is reversed with the freedom to write the metric signature as either of $\{\mp \pm \pm \pm\}$. This will reduce the topological discontinuities from appearing at \mathcal{H} and \emptyset to one in \mathcal{H} alone.¹ Everything is reset at \mathcal{H} , so there is not so pressing a question of how solutions might be transmitted through it. The act of observation associated with \mathcal{H} gives us more options for dealing with discontinuity there.

Another issue is that the we have associated the region of metric discrepancy with the classically forbidden region of an elementary QM barrier problem, but the forbidden region always has the same metric as the allowed region in such problems. Investigation is required to determine whether the usual mechanics of real and imaginary wavenumbers are permitted simultaneously with a changing metric signature. If the unit cell is constructible so as to avoid a discrepancy at \emptyset , then what appears as damping in a 1D QM scattering problem will be manifested in the unit cell as oscillating propagation in the direction perpendicular to the page. In this way, the energy landscape guides undamped propagation in the lattice. If the branch of χ^4 beyond a metric discrepancy is classically forbidden, then states will want to avoid that branch without any need to introduce supplemental mechanisms. The energy landscape will automatically favor continuation onto the classically allowed branch.² Such conditions are the heart of physics. In the previous sections, we have mostly proposed abstract mathematical mechanisms for what \hat{M}^3 is or does, but now we have taken a step toward the physical nitty gritty.

To finish this section, we will mention that a topological mismatch between Σ^\pm forbids perfect transmission from one box into another though this is the boundary condition supposed in (1.7.16) if the box is the full unit cell. Barring the obvious case where Σ^\pm are two different boxes, one resolution is that we might consider the unit

¹In Section 0.2, we introduced a convention in which the 4D metrics in Σ^\pm were oppositely signed as $\{\mp \pm \pm \pm\}$. Here, we use the same sign convention $\{- + + +\}$ for both sides of the unit cell and add the sign conjugated convention in the spaces crossed by $i\chi^4_\pm$.

²If a right-moving wave avoids a forbidden region by diverting onto the directions into *and* out of the page, one might expect attenuation in the lattice. The non-unitary property of \hat{M}^3 should counteract this potential for attenuation.

cell as a small but non-trivial box with symplectic geometry between its piecewise Σ^\pm parts. Symplectic geometry equips a manifold with a 2-form whose property $dx \wedge dy = -dy \wedge dx$ at least approximates what is intended for the conjugation algebra of \mathbb{C}^* with $(\hat{\varphi}^*)^* \neq \hat{\varphi}$.

1.7.4 The Schrödinger Equation and its Potential Modifications

The Schrödinger equation

$$i\hbar\partial_0 |\psi, t\rangle = \hat{H} |\psi, t\rangle = \left(-\frac{\hbar^2}{2m}\nabla^2 + \hat{V} \right) |\psi, t\rangle \quad , \quad (1.7.31)$$

provides an excellent template for what a physical equation looks like. The appearance of both time and space derivatives remedies the problem of equal-time parallel transport cited for \hat{M}^3 as a translation operator in Section 1.7.1. With such an equation for \hat{M}^3 , we would obtain its analytical form as we have obtained the ladder operators in Section 1.7.2.

While Schrödinger's equation incorporates the requisite elements of physics lacking in the current description of \hat{M}^3 , it may or may not be sufficient for MCM evolution on its own. If it is, \hat{M}^3 will show up as a new energy in \hat{H} :

$$\hat{M}^3 |\psi; \hat{\pi}^0\rangle = 2\pi\Phi |\psi; \hat{\pi}^1\rangle \quad \longleftrightarrow \quad \hat{H}_{\text{MCM}} |\psi_E\rangle = E_{\text{MCM}} |\psi_E\rangle \quad . \quad (1.7.32)$$

To evaluate this form for \hat{M}^3 , we must first examine whether or not $|\psi, \hat{\pi}^0\rangle$ is an eigenstate of \hat{M}^3 . Since $[\hat{\mathcal{U}}, \hat{H}] = 0$, an energy eigenstate $|\psi_E; t_0\rangle$ is an eigenstate of $\hat{\mathcal{U}}$ despite the values in the ket changing:

$$\hat{\mathcal{U}} |\psi, t_0\rangle = |\psi; t\rangle \quad . \quad (1.7.33)$$

The time dependence boils down to a phase, and the state remains the same. Since we have not found the analytical form of \hat{M}^3 needed to test whether it commutes with \hat{H} , we cannot say if ψ_E is an eigenstate of \hat{M}^3 . Non-unitarity and changing scale across levels of aleph suggest it may not be. However, the mathematical expression for being sent to a higher level of aleph may be as simple as an accrued $\hat{\pi}$ so that $\hat{\pi}^k \rightarrow \hat{\pi}^{k+1}$ in the way that energy eigenstates acquire a phase under operation with $\hat{\mathcal{U}}$: $e^0 \rightarrow e^{iEt/\hbar}$. If ψ_E is not an eigenstate of \hat{M}^3 and $[\hat{M}^3, \hat{H}] \neq 0$, a likely resolution is that \hat{M}^3 should satisfy a modified Schrödinger equation. In that case, \hat{M}^3 will show up in the time derivative part of an equation which reduces to Schrödinger's equation in the limit of vanishing χ^4 and vanishing derivatives with respect to χ^4 . For example,

one would consider equations roughly in the form

$$(\hat{M}^3 + i\hbar\partial_0)|\psi, t; \hat{\pi}^0\rangle = \hat{H}_{\text{MCM}}|\psi', t'; \hat{\pi}^1\rangle . \quad (1.7.34)$$

where \hat{M}^3 contains a new time derivative on the left, and \hat{H}_{MCM} contains a new energy on the right.

The unitary time evolution operator \hat{U} satisfies Schrödinger's equation on its own. We may factor out the $|\psi, t_0\rangle$ time-independent part of $|\psi, t\rangle = \hat{U}(t, t_0)|\psi, t_0\rangle$ to write an equation for \hat{U} rather than ψ . In that way, \hat{M}^3 may satisfy a time evolution equation without ψ in it at all. This was more or less the original idea in supposing $\hat{Y} = \hat{U} + \hat{M}^3$ [3, 30]. Given

$$i\hbar\partial_t\hat{U} = \hat{H}\hat{U} , \quad (1.7.35)$$

we would write

$$i\hbar\partial_t\hat{Y} = \hat{H}_{\text{MCM}}\hat{Y} , \quad (1.7.36)$$

or we would seek new equations. We will treat \hat{Y} in Section 1.11 where its cases for use in an MCM total evolution equation are discussed beyond the modifications presented here.

The remainder of this section catalogs avenues along which Schrödinger's existing equation might be modified without starting over from scratch. This should be useful and/or demonstrative because any new MCM equation should contain Schrödinger's equation as a limit. Possible modifications are listed and then described.

- Schrödinger evolution in χ^4 :

$$\partial_0 \rightarrow \partial_4 \quad (1.7.37)$$

- A time gradient:

$$\partial_0 \rightarrow \tilde{\nabla} = \partial_0\mathbb{1} + \partial_4\hat{\Phi} , \quad \text{where} \quad (\mathbb{1}, \hat{\Phi}) = (\hat{\pi}^0, \hat{\Phi}^1) \quad (1.7.38)$$

- Momentum in the χ^4 direction:

$$\nabla_i^2 \rightarrow \hat{\nabla}^2 = \nabla_i^2 + \nabla_4^2 \quad (1.7.39)$$

- A separable potential energy:

$$\hat{H} \rightarrow \hat{H} = \hat{H}_0 + \hat{V}(x, t) + \hat{V}_{\text{MCM}}(\chi^4, t) \quad (1.7.40)$$

- A non-separable potential energy:

$$\hat{H} \rightarrow \hat{H} = \hat{H}_0 + \hat{V}_{\text{MCM}}(x, \chi^4, t) \quad (1.7.41)$$

- Classical transport of a quantum system:

$$\dot{\psi} \rightarrow x \quad \Longrightarrow \quad F_{\text{net}} = m\ddot{x} \rightarrow m\ddot{\psi} \quad (1.7.42)$$

Schrödinger Evolution in χ^4 An elementary modification $\partial_0 \rightarrow \partial_4$ on the left side of Schrödinger's equation is such that

$$i\hbar\partial_4|\psi, \chi^4\rangle = \hat{H}|\psi, \chi^4\rangle \quad (1.7.43)$$

This equation is well suited to a further resolution of χ^4 into its piecewise parts: χ_+^4 , χ_\emptyset^4 , and χ_-^4 . It was suggested in [85] that the steps of $\mathcal{H} \rightarrow \Omega \rightarrow \mathcal{A} \rightarrow \mathcal{H}$ might be motions derived from three integrated Schrödinger equations using ∂_+ , ∂_\emptyset , and ∂_- in place of ∂_t on the LHS. Such a description by concatenated integration paths necessarily relies on the sum of three operations rather than the product $\prod \hat{M}_i$ which has been supposed. This might be resolved by moving the \hat{M}_i into an exponential function such that

$$\hat{M}^3 = \prod_{k=1}^3 e^{\hat{M}_k} \quad (1.7.44)$$

This form is familiar from the $\hat{\mathcal{U}} = e^{-i\hat{H}t/\hbar}$ chronological time evolution operator which \hat{M}^3 complements as the chirological evolution operator. Exponential structure in $\hat{\mathcal{U}}$ underpins the path integral as

$$\begin{aligned} \langle x_1 | e^{-i\hat{H}t/\hbar} | x_F \rangle &= \langle x_0 | e^{-i\hat{H}\delta t/\hbar} e^{-i\hat{H}\delta t/\hbar} \dots e^{-i\hat{H}\delta t/\hbar} | x_N \rangle \\ &= \left(\prod_{k=1}^{N-1} \int dx_n \right) \langle x_0 | e^{-i\hat{H}\delta t/\hbar} | x_1 \rangle \langle x_1 | e^{-i\hat{H}\delta t/\hbar} | x_2 \rangle \langle x_2 | \dots | x_N \rangle, \end{aligned} \quad (1.7.45)$$

so (1.7.44) is well suited to piecewise evolutions along MCM cosmological lattice vectors. Taking χ_\emptyset^4 to have no linear extent, meaning the case in which Ω and \mathcal{A} are colocated at \emptyset , one might substitute the requisite chronological evolution $|\psi, t_0\rangle \rightarrow |\psi, t_1\rangle$ for the ∂_\emptyset step of \hat{M}^3 . There is a likeness between \mathcal{H} and \emptyset as obstructions between Σ^\pm , but the mechanism by which we might associate $t \in \mathcal{H}$ and $\chi_\emptyset^4 \in \emptyset$ remains to be investigated. Furthermore, the dimensions of (1.7.43) are contrary to the previous convention in which χ^4 is dimensionless.

A Time Gradient The time gradient $\tilde{\nabla}$ follows from $\partial_0 \rightarrow \partial_4$. Rather than replacing ∂_0 with ∂_4 , we supplement the Schrödinger equation's chronological time derivative with an added chirological part:

$$i\hbar\tilde{\nabla}|\psi\rangle = i\hbar(\partial_0\hat{\pi} + \partial_4\hat{\Phi})|\psi\rangle = \hat{H}|\psi'\rangle . \quad (1.7.46)$$

A deficiency is that the gradient ought to include components for the other ontological basis vectors as

$$\tilde{\nabla} = \partial_0\hat{\pi} + \partial_+\hat{\Phi} + \partial_{\varnothing}\hat{i} + \partial_-\hat{2} . \quad (1.7.47)$$

This does not appear to respect the ordering of the $\mathcal{H} \rightarrow \Omega \rightarrow \mathcal{A} \rightarrow \mathcal{H}$ steps, but that might be remedied if the disordered derivatives vanish as needed during piecewise motions across the unit cell. Perhaps $\hat{2}$ and \hat{i} should be removed from the time gradient on the grounds that they indicate physical and abstract space contrary to the $\hat{\pi}$ and $\hat{\Phi}$ that we have used to indicate physical and abstract time.

As written in (1.7.46), integrated motion along χ^4 would raise the level of aleph with $\hat{\Phi}$ acting on the χ^4 part of $|\psi, t, \chi^4\rangle$, but the x^0 part does not raise it with $\hat{\pi}^0 = \mathbb{1}$. Operation with the time gradient yields wavefunctions on two levels of aleph. Following the plane wave prescription in the previous section, wavefunctions on different levels of aleph are orthogonal. Hence, \hat{H} operating on ψ would have to result in the sum of two orthogonal states. This is not the behavior usually associated with the \hat{H} operator.

Momentum in the χ^4 Direction Canonical quantization in the position representation is such that

$$p_i \rightarrow -i\hbar\partial_i . \quad (1.7.48)$$

One would assume that momentum in the χ^4 direction quantizes as

$$p_4 \rightarrow -i\hbar\partial_4 . \quad (1.7.49)$$

The kinetic part of the Hamiltonian would be altered as

$$\hat{H}_0 = -\frac{\hbar^2}{2m}\hat{\nabla}^2 = -\frac{\hbar^2}{2m}\sum_{k=1}^4\partial_k^2 . \quad (1.7.50)$$

Within ∂_4 , the $\{\chi_+^4, \chi_{\varnothing}^4, \chi_-^4\}$ structure is such that each variant should be given its own derivative. In the picture of ontological basis vectors as cosmological lattice vectors, one would assume the possibility for arbitrary momenta in the form $\mathbf{p}_4 =$

$(a\hat{\chi}_+^4, b\hat{\chi}_\emptyset^4, c\hat{\chi}_-^4)$. In that case, one might omit the spatial momentum of physical 3-space to write

$$\hat{H}'_0|\psi\rangle = -\frac{\hbar^2}{2m}(\partial_+^2 + \partial_\emptyset^2 + \partial_-^2)|\psi\rangle \quad . \quad (1.7.51)$$

However, (1.7.51) assigns physical dimension to the abstract coordinates which probably ought to be dimensionless. In that case, one would drop the \hbar^2/m from (1.7.51) with an intention to write a Schrödinger equation completely in the abstract coordinates. Furthermore, (1.7.49) may not be the correct quantization prescription at all. The three-fold structure on χ^4 is such that its prescription for quantization might be exotic.

A New Separable or Non-Separable Potential Energy Function While the KKT requirement for a vanishing 5D Ricci tensor is an obstacle to the direct introduction of a new polynomial energy function of χ^4 , the physical concept of a unit cell invokes a regular, periodic potential energy function. Such a function is the foundation of lattice physics. An upside down Dirac comb forbidding the bulk of Σ^\pm while allowing the labeled branes seems like an energy that would motivate $\mathcal{H} \rightarrow \Omega \rightarrow \mathcal{A} \rightarrow \mathcal{H}$ as a generalized Euler–Lagrange process. What a new periodic term in \hat{H} might be when KKT requires no 5D matter-energy deserves further study.

Another issue is that we have no units for χ^4 (yet), but any new energy function must be quantifiable in Joules if it is of the separable variety. Non-constant energy functions always depend on the units of the coordinates to achieve the dimensionality of energy. An example of a non-separable, new energy function not requiring dimensionful χ^4 is one where a dimensionless piece associated with the unit cell multiplies part of an existing Hamiltonian, or all of it. This would represent, for example, the scale factor for changing energies across changing levels of aleph (Section 1.7.3). For dimensionful χ^4 , the MCM plane wave ansatz must be revised as

$$\psi(\mathbf{x}, t, \chi_\pm^4) = \exp\{i(\mathbf{k} \cdot \mathbf{x} - \omega t + \beta_\pm \chi_\pm^4)\} \quad , \quad (1.7.52)$$

where β_\pm is a frequency or wavenumber analogue. If we are to keep the Schrödinger equation's time derivative part as it is, the only possibility for new physics is a new energy term. While this strongly suggests that a fundamental modification to the time derivative part of Schrödinger's equation is required, we will briefly examine the case in which a third derivative associated with \hat{M}^3 appears as a new energy term.

Operating on ψ with ∂_4^3 will bring down three powers of the scalar β . As written, (1.7.52) allows plane waves to propagate only along cosmological lattice vectors. To

add propagation in the direction of arbitrary superpositions of lattice vectors, which is to allow waves with arbitrary $\mathbf{p}_4 = (p_+, p_\emptyset, p_-)$, the ansatz must be revised as

$$\psi(\mathbf{x}, t, \boldsymbol{\chi}^4) = \exp\{i(\mathbf{k} \cdot \mathbf{x} - \omega t + \boldsymbol{\beta} \cdot \boldsymbol{\chi}^4)\} \quad , \quad \text{with} \quad \boldsymbol{\chi}^4 = (\chi_+^4, \chi_\emptyset^4, \chi_-^4) \quad . \quad (1.7.53)$$

In this case, the third derivative will bring down a vector $|\boldsymbol{\beta}|^2 \boldsymbol{\beta}$ resulting in an eccentric analytical expression:

$$i\hbar \partial_0 \psi = (\hat{H}_0 + i\partial_4^3) \psi = \left(\frac{|\mathbf{p}|^2}{2m} + |\boldsymbol{\beta}|^2 \boldsymbol{\beta} \right) \psi \quad . \quad (1.7.54)$$

What would be the meaning of the sum of a scalar and a vector? The main venue for such a sum in physics is the quaternions. The sum of a vector and a scalar cannot be written off immediately as nonsensical because the MCM Hamiltonian for time arrow spinors (Section 12) is quaternion-valued [85]. Furthermore, the behavior of even derivatives to return scalars and odd derivatives to return vectors may be useful in a scheme for separating odd and even levels of aleph.

Classical Transport of a Quantum System Since the introduction of a third derivative into the formalism is desired, we might combine the first order Schrödinger equation with Newton's second order force law such that

$$i\hbar \dot{\psi} = \hat{H} \psi \quad , \quad \text{and} \quad m \ddot{\psi} = F_{\text{MCM}} \quad . \quad (1.7.55)$$

The time derivative of ψ replaces the classical position x . This supplementation of Schrödinger's equation as a classical trajectory for $\dot{\psi}$ across the unit cell may be useful for avoiding KKT Ricci tensor violations in the bulk because the quantity $\dot{\psi}$ is not directly associated with matter-energy distributions. It is only the rate of change of a complex-valued probability amplitude.

As an off-the-cuff example of what is meant by classical transport of a quantum system, consider that lattice physics is an extended application of Hooke's law. Restricted to positive displacements, Hooke's law is

$$m\ddot{x} = kx \quad \implies \quad \ddot{x} = \frac{k}{m} x \quad . \quad (1.7.56)$$

One might attempt to associate the oscillation of masses connected by springs (lattice sites) with the oscillation of the wavefunctions attached to each lattice site. Since the Hamiltonian is constructed from the Lagrangian as $H = \sum p\dot{q} - L(q, \dot{q})$, (1.7.56) offers an easy way to introduce a third derivative term into the energy function.

Substituting the oscillation of position with the oscillation of the wavefunction allows us to put the third derivative directly into the $L(q, \dot{q})$ function with $\ddot{x} \propto \dot{x}$.

1.8 Wavefunction Collapse

1.8.1 A Possibility for Retrocausality

A good and modern overview of issues related to retrocausality in wavefunction collapse is found in [86]. To paraphrase briefly, Ellerman's thesis is that Schrödinger's cat is in an entangled superposition of life and death eigenstates while the box is closed, and that opening the box does not retrocausally affect the life or death of the cat during that time. Rather, opening the box forces the collapse of the life/death superposition into one eigenstate or the other by placing a detector outside of the box. Detectors are modeled in QM as operators which project quantum systems onto their eigenstates. If the box is opened at time t , then the wavefunction is collapsed only for times later than t . Ellerman contends, rightly, that the language of QM is not such that we may determine the life or death of the cat prior to the measurement. This writer's minor criticism, however, is the lack of a caveat: Ellerman assumes that QM is the correct description of nature. He discounts the possibility that QM is merely a hack allowing us to predict experiments' results. He does not contextualize the possibility that such effects as retrocausality may be objectively *real* even while QM does not predict them. What is real or not is a matter of semantics, *or not*, but it remains true that there may exist a better description of reality than QM. The interpretation of that other description might suggest retrocausality.

Even while this writer agrees with Ellerman regarding the interpretation of QM, it is not known what is inside the closed box. Not knowing what is inside is different than knowing that there is a superposition. If QM's usual interpretation is correct, which we have fair reason to suspect, then we would know that the cat exists as a superposition until a detector projects it into one of its life eigenstates. Even then, the reader is encouraged to understand that opening the box may, in fact, retrocausally affect the life or death of the cat because ignorance of the cat's state is not exactly knowledge that the state is a superposition. That implication depends on an assumption that QM is more than just a hack for telling the results of experiments. Obviously, this writer's opinion on QM is exactly that. There probably does exist a better theory than QM. Whether or not a better description would preclude retrocausality is unknown. The context for retrocausality in the MCM is that the EM potential A^μ in \mathcal{H} is a superposition of contributions from A^μ_\pm in Σ^\pm (Section 16), so it follows that physics in the present is at least retrocausal from the abstract future

$\chi_+^4 > 0$. How that may or may not relate to objective, chronological retrocausality from the Minkowskian future light cone remains to be determined.

1.8.2 A Thought Experiment for Retrocausality

Consider a Schrödinger's cat experiment in the presence of a time machine. A cat is placed inside a box with a radioactive isotope. A detector will release a poison if the isotope decays. There exists a clock stationary in the box' lab frame which measures lab time. The isotope is removed after a duration of time such that there is a 50% chance of the cat being poisoned. The isotope is removed automatically from the box at lab time t_0 . Then the box is opened at $t_2 > t_0$, and the cat is observed to be alive or dead. After that, the observer uses the time machine to travel back in time. In the past, he opens the box at lab time t_1 such that $t_0 < t_1 < t_2$. The isotope was already removed from the box at t_0 , so the poison was either released or not before t_1 . If wavefunction collapse does not have retrocausal effects, there should be a 50% chance of finding the cat either alive or dead at t_1 despite the cat being found in one state or the other at t_2 . The theory of quantum mechanics predicts that the collapse of the cat's wavefunction to the alive or dead eigenstate at t_2 should not effect the probability for observing one state or the other in the past at t_1 , but theory alone is not sufficient to determine the outcome of an experiment. It is possible that real time machine experiments would show that if the cat is observed to be alive or dead at t_2 , then opening the box at t_1 will always yield a like result. The interpretation would be that life or death was decided before t_0 when the isotope was removed. In that case, quantum theory would have to concede the retrocausal effects disputed in [86]. Without doing the experiment, there is no way to know what the result would be. Even if the result of the experiment showed that the cat's state at t_1 does not universally agree with the state at t_2 , the many worlds interpretation of QM would still make it impossible to conclude that the cat was in a superposition prior to the respective measurements.

1.8.3 The Collapse Problem

The issue of collapse is mysterious independently from any questions about causality. How *exactly* does a detector put a superposition quantum state into an eigenstate? Neither quantum theory nor its interpretations offer a good answer to this question.

It is intrinsic to QM that observables are represented by Hermitian operators. Once that is established, mathematical collapse by projection follows directly. However, the axiom that a physical detector should be represented by a non-physical instantaneous

collapse operator is unsatisfying. If an operator acts on a non-eigenstate at time t_0 , and an eigenstate is instantaneously output, one could ask about the state at t_0 and get two good answers, or two bad ones. Although we might make an appeal to uncertainty in the experimental resolution of time, QM is a theory of states in Hilbert space *at a definite time*. Is the state at t_0 collapsed or diffuse? Is it semi-diffuse? State reduction is a discontinuous mathematical operation, but an appeal to the $\Theta(t - t_0) = \frac{1}{2}$ property of the Heaviside function cannot tell us anything about the physics at t_0 because the theory of linear operators does not permit halfway collapse in progress. So, it is disappointing that QM provides no equations of motion such that diffuse, unmeasured superposition states might evolve smoothly into sharp, measured eigenstates. Due to Schrödinger's equation being a heat equation, Schrödinger evolution can only broaden probability distributions. It can never narrow them. This flies in the face of what is observed: wavefunctions diffuse, and then they collapse. Something more than $\mathcal{H} \rightarrow \mathcal{H}$ Schrödinger evolution *must* take place between consecutive measurements. The intermediate steps of $\mathcal{H} \rightarrow \Omega \rightarrow \mathcal{A} \rightarrow \mathcal{H}$ are introduced to accommodate a theoretical structure for that additional process. Two extra steps will allow us to add one step of new physics and a second step to ensure that the new physics arrives at the known result, albeit with a better explanation than QM provides.

In general, the action of an observation on a quantum state is a projection into one of the corresponding operator's eigenstates. However, the action of that operator on a state is

$$\hat{A}|\psi\rangle = \hat{A} \sum c_n |a_n\rangle = \sum c_n a_n |a_n\rangle . \quad (1.8.1)$$

This has not executed the projection operation. Namely, a measurement of observable A should be

$$\hat{P}_k |\psi\rangle = |a_k\rangle , \quad (1.8.2)$$

so that if eigenvalue a_k is obtained from the first measurement, any number of rapidly repeated measurements will also yield a_k . In (1.8.2), \hat{P}_k has *projected* ψ into the 1D eigenspace spanned by $|a_k\rangle$. Unfortunately, there is no dynamical equation for this, and we must say, "This is where the magic happens." Only *after* finding eigenvalue a_k , collapse is implemented by operating with

$$\hat{P}_k = \frac{1}{c_k} |a_k\rangle \langle a_k| . \quad (1.8.3)$$

This extra step at the end of a time evolution is unnatural and clunky, but it is the best QM has to offer for a mathematical description of wavefunction collapse.

Regarding two events a and b and their corresponding measurements A and B ,

it is known that the states observed at A and B cannot be δ functions. δ functions are not valid wavefunctions in the sense of the Born interpretation which says that a wavefunction's modulus squared is a real number. δ functions are also non-compliant with Heisenberg uncertainty. However, it is an open question of ontology and/or epistemology whether or not δ functions are part of the process. QM says nothing about whether a physical detector forces a quantum state into a mathematically singular δ function at a or b , or only into the width of an experimental resolution. To wit, there exist two position operators: \hat{x} and $\hat{X}_{x_1}^{x_2}$. The first asks where the particle is, and the second asks if the particle is between x_1 and x_2 . Projection onto an eigenstate of \hat{x} kicks the state out of Hilbert space as

$$\hat{P}_{\hat{x}} : \underbrace{\left\{ \int dk A(k) e^{i(kx-\omega t)} \right\}}_{\text{wavepackets}} \rightarrow \underbrace{\left\{ \delta(x - x_0) \right\}}_{\text{eigenstates of } \hat{x}} . \quad (1.8.4)$$

This means that projection onto an eigenstate of \hat{x} at a or b cannot possibly return the narrowly peaked wavepacket observed at A or B . In terms of the RHS $\{\mathcal{H}', \mathcal{A}', \Omega'\}$, (1.8.4) reads as $\hat{P}_{\hat{x}} : \mathcal{H}' \rightarrow \Omega'$. On the other hand, $\hat{X}_{x_1}^{x_2}$ is such that

$$\hat{P}_{\hat{X}} : \underbrace{\left\{ \int dk A(k) e^{i(kx-\omega t)} \right\}}_{\text{wavepackets}} \rightarrow \underbrace{\left\{ \int dk A(k) e^{i(kx-\omega t)} \right\}}_{\text{eigenstates } \hat{X}_{x_1}^{x_2}} . \quad (1.8.5)$$

Since a physical measurement can never give us more information than whether or not a particle is found in some region, $\hat{X}_{x_1}^{x_2}$ represents a physical measurement while \hat{x} does not. So, there exists an important, open question about what is really going on at a and b .

In the psychological picture of the MCM, the observer learning that the particle is or is not in a given region is the measurement A or B , not the event a or b . δ -valued states are not observable, and the question of the unobserved state at a or b remains open: does the wavefunction collapse to a δ function between A and B , or does it not? Although the eigenstates of \hat{x} are not observable, do they correspond to the results of the state interacting with a detector at the events a and b ? The inability of QM to answer this question is referenced when it is asked if QM might be “a hack.” We would like the theory to tell us about a and b , but it only tells us about A and B . QM works around the deeper issue regarding fundamental interactions while answering the practical question about what is visible. A quantum mechanic from Copenhagen might argue that asking about the ontological realism of a state away

from A or B is a blunder because that knowledge does not exist, but the truth is only that such knowledge does not exist within QM. It might exist, and another theory might describe it. The three-fold process of \hat{M}^3 is formulated to add resolution to this gray area. Under \hat{M}^3 , an event happens at a , the results of which are observed at A . Then one predicts what will happen at b , waits for b to happen, and then observes the results of b at B .

We want to know how probability distributions can become narrower when the Schrödinger equation only broadens them, and we want to know if they become singularly narrow as δ functions at some point during the transit of the unit cell. If there is a layer of quantum theory where δ functions are obtained, that layer would be uniquely well suited to connections with the theory of test masses moving along geodesics in relativistic spacetime because GR is a theory of points, or position eigenstates. Thus, the MCM's three-fold structure is purposed toward to answering such questions about the separateness of the a, b event layer and the A, B observation layer. Suggesting the relevance of the time lag between the two, the MCM prediction that observables should be correlated with the delay between an event and its measurement was confirmed in BaBar's observation of time reversal symmetry violation (Section 0.1) [32]. Such delay effects are consistent with a state collapsing to a δ function at an event, and then returning to the Hilbert space as a wavepacket when the observer is eventually notified of the event.

Due to Weyl's criterion, the eigenstates of an operator with a continuous spectrum can be approximated to arbitrary precision by the states in the operator's domain of self-adjointness.¹ Referring to (1.8.4), Weyl's criterion says that a δ function may be well approximated by wavepackets from the Hilbert space. If one substitutes the approximate eigenvectors for the real eigenvectors, the $\hat{P}_{\hat{x}}$ projection operator can output the state which is observed at A or B . In this approximation, $\hat{P}_{\hat{x}} : \mathcal{H}' \rightarrow \mathcal{H}'$ does not kick states out Hilbert space, and there is no inherent appeal to rigged Hilbert space. However, the method of approximate eigenvectors identifies a, b with A, B when the real time lag between them leaves room for additional physics. QM has little or nothing to say about this lag, and the Weyl convention for approximate eigenvectors presumes its non-existence.

It is acutely important for the MCM whether or not the state actually collapses to a δ function, so we must not preclude the possibility for δ functions to appear in the chirological time evolution of a state from \mathcal{H}_k to \mathcal{H}_{k+1} . For instance, if there are no

¹Unbounded operators such as \hat{x} and \hat{p} are typically not self-adjoint on all of Hilbert space. The subspace of Hilbert space on which an operator is self-adjoint (Hermitian) is the main limitation selecting the \mathcal{H}' subspace of Hilbert space \mathcal{A}' as the space of physical states in RHS. Since physical observables are represented in QM by self-adjoint operators, physical states must reside within an operator's domain of self-adjointness.

δ -valued states during a transit of the unit cell, then there is no place in the theory for states unique to the Ω' part of rigged Hilbert space. In turn, this will affect the MCM scheme of fundamental particles because the three generations of matter particles are (presently) associated with the three RHS state spaces. A distinct and potentially useful property of the Ω' states is that a wavepacket $u(x, t) \in \mathcal{H}'$ will thermalize, or diffuse, such that

$$|\psi, t_0\rangle = c_0(t_0)u_0(x) \quad \longrightarrow \quad |\psi, t_1\rangle = \sum_j c_j(t_1)u_j(x) \quad . \quad (1.8.6)$$

However, if that same state is moved into Ω' as

$$\psi \in \mathcal{H}' \subset \Omega' \quad \implies \quad \psi \in \Omega' \quad , \quad (1.8.7)$$

then we should expect distinct thermalization behavior on the expanded basis:

$$|\psi, t_0\rangle = c_0(t)u_0(x) \quad \longrightarrow \quad |\psi, t_1\rangle = \sum_j c_j(t_1)u_j(x) + \sum_k d_k(t_1)\delta(x - x_k) \quad .^1 \quad (1.8.8)$$

Such behaviors might be observably correlated with correlation amplitudes.

δ functions are also desirable for applications toward quantum gravity. The layer of quantum collapse to a δ function at a, b is well suited to communication with GR because GR is a theory of points in spacetime. Points are exact time and space eigenstates, not approximate ones. Although it is required to describe measurements with $\hat{X}_{x_1}^{x_2}$, an association of events with \hat{x} introduces a layer where the objects of quantum theory are mathematically compatible with the objects in the theory of gravitation. For this reason and others, the MCM mechanism for wavefunction collapse should aim to produce mathematically singular δ functions.

1.8.4 The Double Slit Experiment

The double slit experiment is depicted in Figure 11. In Section 1.8.5, we will examine the problem of the wavefunction collapsing to a point of scintillation at t_s . In this section, we will examine only the destruction of the interference pattern on the screen when the path through the slits is measured.

With two slits labeled R and L , the MCM proposal to explain the observed wave-

¹For convenience, we use discrete notation for continuous states.

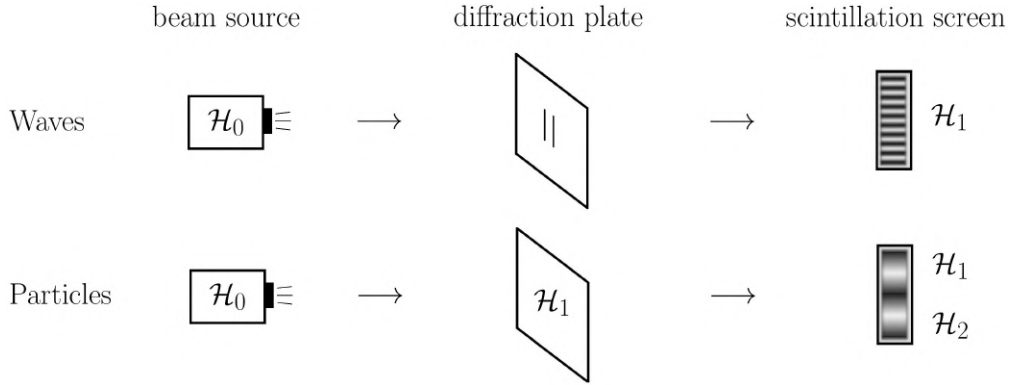

Figure 11: Above, measurements at the source and screen are taken in \mathcal{H}_0 and \mathcal{H}_1 . No measurement is made to determine which slit the particle passed through. After many repetitions, wave interference is observed on the screen because the monochromatic wavefronts emanating from each slit are on the same level of aleph. Below, three measurements are made. In addition to looking at the source and screen, the observer determines which slit the particle passes through. After many repetitions, wave interference is not observed because the intermediate measurement increased the level of aleph for the wavefront coming through one slit or the other. Waves on different levels of aleph cannot form interference patterns because they are orthogonal.

particle duality [71] is

$$\text{Waves} \longrightarrow \begin{cases} |\psi_R, t_0; \hat{\pi}^0\rangle \rightarrow |\psi_R, t_p; \hat{\pi}^0\rangle \rightarrow |\psi_R, t_s; \hat{\pi}^1\rangle \\ |\psi_L, t_0; \hat{\pi}^0\rangle \rightarrow |\psi_L, t_p; \hat{\pi}^0\rangle \rightarrow |\psi_L, t_s; \hat{\pi}^1\rangle \end{cases} \quad (1.8.9)$$

$$\text{Particles} \longrightarrow \begin{cases} |\psi_R, t_0; \hat{\pi}^0\rangle \rightarrow |\psi_R, t_p; \hat{\pi}^1\rangle \rightarrow |\psi_R, t_s; \hat{\pi}^2\rangle \\ |\psi_L, t_0; \hat{\pi}^0\rangle \rightarrow |\psi_L, t_p; \hat{\pi}^0\rangle \rightarrow |\psi_L, t_s; \hat{\pi}^1\rangle \end{cases} . \quad (1.8.10)$$

A first measurement regards the preparation of a monochromatic particle beam at t_0 . This measurement takes place in \mathcal{H}_0 , so the state of a particle at the source is

$$|\psi, t_0; \hat{\pi}^0\rangle = \frac{1}{\sqrt{2}}|\psi_R, t_0; \hat{\pi}^0\rangle + \frac{1}{\sqrt{2}}|\psi_L, t_0; \hat{\pi}^0\rangle . \quad (1.8.11)$$

The total probability amplitude is the sum of the amplitudes for going through the upper and lower slits. At t_p , the beam hits the diffraction plate. Then it continues as ψ_R and ψ_L waves having slits R and L as their respective sources. If no measurement is made at the slits, each will emit a wavefront of probability amplitude on the $\hat{\pi}^0$

level of aleph. (Recall that $\hat{\pi}^k$ levels of aleph enumerate successive measurements.) Since ψ_R and ψ_L are monochromatic and on the same level of aleph, they are not orthogonal. The waves will interfere, and a subsequent measurement at t_s will never show a particle arriving on the screen at the minima between interference fringes. Many repetitions will show that the probability distribution on the screen is consistent with interference between wavefronts sourced from R and L , as in (1.8.9).

Early attempts to explain wave-particle duality in the double slit experiment resulted in the uncontrollable disturbance hypothesis. It was supposed that the act of measurement cannot be *ideal*, and that, therefore, the measurement interaction between two quantum systems adds an unobservable phase to the observed state: ψ_R or ψ_L . In turn, that phase destroys the interference pattern. The uncontrollable disturbance explanation has not panned out, and increasingly complicated workarounds were formulated so as to avoid the conclusion that the particle knows about what will happen at t_p . However, the double slit experiment is very strange, and no one understands it. It is hard to avoid the conclusion that the particle somehow *knows* whether or not an observer will determine the path through the diffraction plate. If a position measurement is made at t_p , it is *usually* said that the particle knows to go through one slit or the other. As a result, the interference pattern is destroyed due to the lack of any wave emittance from the other slit. This explanation is unsatisfying because the particle should not know anything other than to obey the action principle.

A superior MCM explanation for the observed phenomenon is that the particle *always* goes through both slits [71]. Rather than knowing what the observer will do at t_p , a measurement at the diffraction plate separates ψ_R and ψ_L onto different levels of aleph. The interference pattern is destroyed because orthogonal plane waves cannot interfere, as in (1.8.10). (Orthogonal plane waves were developed in Section 1.7.3.) The problem that remains is to formulate a mechanism by which the collapse associated with an intermediate measurement at t_p will separate ψ_R and ψ_L onto two different levels of aleph. An alternative mechanism might invoke the action associated with a transit of the unit cell so that the particle choosing one slit or another in the presence of an intermediate measurement *does* reflect the action principle. Crossing an extra unit cell would have greater action favored by the maximum action principle. In the remainder of this section, however, we will consider the former process from [71]: the particle always goes through both slits.

The MCM plane wave ansatz is

$$\psi(\mathbf{x}, t, \chi^4) = e^{i(\mathbf{k}\cdot\mathbf{x} - \omega t + \beta\chi^4)} \quad . \quad (1.8.12)$$

The double slit application requires β whether or not χ^4 is dimensionless. To use the rules for orthogonal plane waves (Section 1.7.3), we must encode the level of aleph onto the χ^4 part of the argument with β . Following the usual notation for

$$\phi(\mathbf{x}, t) = A_0 e^{ik_\mu x^\mu} = A_0 e^{i(\mathbf{k}\cdot\mathbf{x} - \omega t)} \equiv |k_\mu\rangle \quad , \quad (1.8.13)$$

we will write the ansatz as

$$\psi(\mathbf{x}, t) = A_0 e^{ik_A x^A} \equiv |k_A\rangle \quad . \quad (1.8.14)$$

The minus sign on ωt in (1.8.13) follows from the $\{- + + +\}$ metric signature in \mathcal{H} . The sign on χ^4 in (1.8.14) will depend on the $\{- + + + \pm\}$ metric signature in Σ^\pm . Intermingling for simplicity the abstract and physical coordinates, and ignoring the constant A_0 , the orthogonality of MCM plane waves follows as

$$\langle k'_A | k_A \rangle = \underbrace{\int_{-\infty}^{\infty} dt e^{-i(\omega - \omega')t}}_{\delta(\omega' - \omega)} \underbrace{\iiint d^3x e^{i(\mathbf{k} - \mathbf{k}')\cdot\mathbf{k}}}_{\delta^{(3)}(\mathbf{k} - \mathbf{k}')} \int_{-\infty}^{\infty} d\chi^4 e^{i(\beta - \beta')\chi^4} \quad . \quad (1.8.15)$$

If the χ^4 part is like a small box plane wave (Section 1.7.3), β should be discrete, and the integral over χ^4 becomes the Kronecker δ . If β is continuous, it becomes the Dirac δ . The case of discrete β_n lends itself directly to the identification of lattice sites or levels of aleph. Since each piecewise χ_\pm^4 or χ_\emptyset^4 has its origin in a given brane with a corresponding scale, β_n would be a scale factor used to preserve the notion of disparate relative scale between levels of aleph. This scale must be considered when taking the inner product of states on different levels of aleph. For instance, the inner product of states in the μ - and ν -branes on the m and n levels of aleph would be

$$\langle k'_A | k_A \rangle = \langle \psi'; \hat{e}_\nu^n | \psi; \hat{e}_\mu^m \rangle = \underbrace{\int d^4x e^{i(k_\lambda - k'_\lambda)x^\lambda}}_{\langle \psi' | \psi \rangle} \underbrace{\int_{-\infty}^{\infty} d\chi^4 e^{i(|\hat{e}_\mu|^m - |\hat{e}_\nu|^n)\chi^4}}_{\delta_{\mu\nu} \delta_{mn}} \quad . \quad (1.8.16)$$

We have previously obtained the relative scale $2\pi\Phi$ between two \mathcal{H} -branes as the increase of scale at each labeled brane by an amount proportional to the magnitude of its ontological specifier, as in Figure 12. The β in (1.8.16) imposes that relative scale on χ^4 in the plane wave state: the scale is the absolute value of \hat{e}_μ^m . Considering the big box case of unbounded plane waves, however, β is continuous rather than discrete. This continuum of scale factor is also seen in Figure 12. Using notation in which the continuous χ^4 parameter associated with the primed level of aleph is

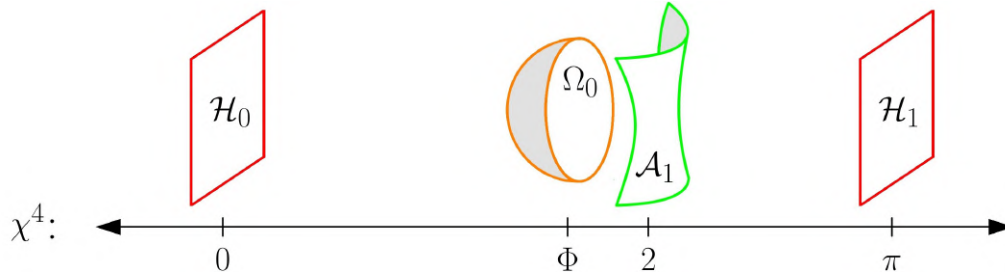

Figure 12: The monotonic increase of $|\hat{e}_\mu|$ across the unit cell's labeled branes suggests a continuum of scale factor β .

$\chi' = \beta' \chi^4 + c'$, we would write

$$\langle \psi'; \hat{e}_\nu | \psi; \hat{e}_\mu \rangle = \langle \psi' | \psi \rangle \underbrace{\int_{-\infty}^{\infty} d\chi^4 e^{i(\chi' - \chi'')}}_{\delta(\beta' - \beta'')} . \quad (1.8.17)$$

Either of (1.8.16) or (1.8.17) is sufficient to motivate the wave-particle duality observed in the double slit experiment. All that is required for (1.8.9) and (1.8.10) is that β identifies the level of aleph, and that waves on different levels of aleph are orthogonal. With this condition written plainly, future work must devise a mechanism by which a measurement at t_p will separate ψ_R and ψ_L onto different levels of aleph.

1.8.5 An Application for the Theory of Negative Time

As state reduction (wavefunction collapse) is understood in the present theory, a measurement at time t_0 is essentially such that

$$\dot{\psi}(t_0) = \infty . \quad (1.8.18)$$

This is inherently problematic because ∞ is analytically intractable, and $\dot{\psi}$ obeys

$$i\hbar\dot{\psi} = \hat{H}\psi . \quad (1.8.19)$$

If $\dot{\psi} = \infty$, Schrödinger's equation is only satisfied with unphysical, infinite energy. Furthermore, the time arrow is such that infinite $\dot{\psi}$ will cause total decoherence of the wavefunction rather than total collapse. In this section, we will sketch a theoretical mechanism for the apparent infinite rate of wavefunction collapse, and for a period of Schrödinger coalescence following the usual period of Schrödinger diffusion.

Even without a diffraction grating between a source and a scintillation screen, it

is not known how the wavefunction might undergo smooth diffusion in transit and then suddenly collapse to a point on the screen. Wavepackets evolving under the Schrödinger equation can only become broader, never narrower. It is also not known whether the wavefunction collapses to a δ function on the screen or only down into the region spanned by a finite spot of scintillation. The state's confinement to the spot may be better associated with the time that the scintillation photons reach the observer than it is with the interaction between the beam and the screen. The state at the time of that interaction, b as opposed to B , may be a δ function. So, despite the observer's knowledge being limited by the experimental resolution, we might ask what the wavefunction is *really* doing on the screen. Is it proper to consider a theory in which the observed interaction between the screen and the particle outputs a δ function? While the answers to such questions are not known, it is known that nothing more than one's preference supports the argument against asking what is *really* happening in QM.¹

QM is such that the wavefunction obeys Schrödinger's equation at all times except when measurements are made. There, singular, instantaneous collapse flies in the face of all other known physical processes. Fractional distance analysis offers new tools for recasting $\dot{\psi} = \infty$ as another expression not at odds with physics as usual. Any rate of collapse in the neighborhood of infinity must be observationally indistinguishable from an infinite rate of collapse, so we may replace $\dot{\psi} = \infty$ with

$$\dot{\psi} \in \widehat{\mathbb{R}} \quad \Longrightarrow \quad \dot{\psi}(t_0) = \aleph_{\mathcal{X}} + b \quad . \quad (1.8.20)$$

($\widehat{\mathbb{R}}$ is the positive branch of \mathbb{R} less the neighborhood of the origin and the non-arithmetics, as in Section 1.6.1.) With this rate of collapse, $i\hbar\dot{\psi}(t_0) = \hat{H}\psi(t_0)$ implies a finite Hamiltonian:

$$\left. \begin{array}{l} |\psi|^2 \leq \infty \\ \dot{\psi}(t_0) \in \widehat{\mathbb{R}} \end{array} \right\} \quad \Longrightarrow \quad |\hat{H}\psi| \in \widehat{\mathbb{R}} \quad . \quad (1.8.21)$$

Energy in the neighborhood of infinity is consistent with the principle of maximum action discussed in Section 1.5. Presuming free space between a beam source and a scintillation screen, energy in the neighborhood of infinity requires that we write

$$\hat{H} = \hat{H}_0 + \hat{H}_{\text{int}} \quad . \quad (1.8.22)$$

¹t Hooft's non-MCM cellular automata model of QM addresses similar questions about what really happens in QM with novel objects such as *ontological states*, *beables*, and *changeables*. The cellular automata model is parsed for future inquiry in Section 58.

Here, the interaction energy associated with $\dot{\psi} \in \widehat{\mathbb{R}}$ vanishes everywhere except for the time and place of a measurement. \hat{H}_{int} should not be a function of the chronological time because the observer may choose to make a measurement at arbitrary times. Such a function could not be defined until after t_0 was chosen. Referring back to the double slit experiment, \hat{H}_{int} cannot be a function of the spatial variables alone because collapse only happens at the spatial position of the slits when a measurement is made. Therefore, \hat{H}_{int} should be a function of the chirological time such that the arbitrary $t = t_0$ is associated with a regularized periodicity in χ^4 . For example, we have associated the preparation of a beam with measurement A in \mathcal{H}_0 , so the observation of a subsequent scintillation spot in the path of the beam should be associated with measurement B in \mathcal{H}_1 . Between A and B , event b must occur: the interaction of the beam and the scintillator. We will take that as the place where $\dot{\psi}$ suddenly becomes very large. This sudden change of scale in $\dot{\psi}$ is well associated with the change of the level of aleph at \emptyset which is located at a constant abstract distance between successive \mathcal{H} -branes. Perhaps we might associate event b with the \emptyset -brane and set a δ -like \hat{H}_{int} term at the location of that topological obstruction between Ω and \mathcal{A} . A δ function is a good candidate for an energy that vanishes everywhere except for the event of wavefunction collapse when it becomes infinite or enters the neighborhood of infinity.

Now we have suggested a method by which one might obtain the large $|\dot{\psi}|$ observed in experiments, but it remains to explain the sign on $\dot{\psi}$. For that, we will refer to the theory of negative time. A good application will be to implement dynamical collapse as a step of reversed time evolution in \hat{M}^3 through a region with a reversed time arrow such as Σ^- . (We may also introduce a reversed time arrow in the χ_{\emptyset}^4 coordinates between \emptyset and \mathcal{A} if needed.) Diffusion by Schrödinger evolution in positive time will become coalescence in negative time, as is required for wavefunction collapse.¹ Since this step occurs on the higher level of aleph associated with $\Sigma_{\{k+1\}}^-$, we may appeal to the scale of that level of aleph generating the appearance of discontinuous, non-dynamical collapse as observed from the lower level. The problem of $\dot{\psi} \notin \mathbb{R}^0$ might be further simplified through an appeal to infinite relative scale between two levels of aleph. Using $\dot{\psi}_{\{k\}}$ to refer to the rate of change given in the scale of \mathcal{H}_k , we may obtain

$$\dot{\psi}_{\{0\}} = \aleph_{\mathcal{X}} + b \quad \longrightarrow \quad \dot{\psi}_{\{1\}} = \frac{\dot{\psi}_{\{0\}}}{\aleph_{\mathcal{Y}}} = \frac{\mathcal{X}}{\mathcal{Y}} .^2 \quad (1.8.23)$$

¹Theorem 7.5.29 in [2] shows that two parameters on a curve, one on a higher level of aleph than the other, cannot share an origin, so reverse time coalescence should give δ 's at locations other than those associated with prior collapse.

²Arithmetic in the neighborhood of infinity [2] is such that $(\aleph_{\mathcal{X}} + b)/(\aleph_{\mathcal{Y}} + c) = \mathcal{X}/\mathcal{Y} \in \mathbb{R}^0$. The loss of information about b in (1.8.23) may have applications toward information loss in quantum processes which exceed the scope of the present section.

Here, we assume that normalization of the observer's reference frame onto the $k=1$ level of aleph requires division by $\aleph_{\mathbf{y}} = \mathcal{Y}\widehat{\infty}$. This choice of scale, or a similar one, makes it possible to resolve the apparent instantaneous rate of change observed on one level of aleph as a rate in the neighborhood of the origin on the other level of aleph.

For the present theoretical application, we must refer to the original picture of \hat{M}^3 executing $t_0 \rightarrow t_{\max} \rightarrow t_{\min} \rightarrow t_1$ where $t_1 = (t_0 + \Delta t)$ [30]. We will identify this process with the current one so that Ω is associated with t_{\max} , and \mathcal{A} is associated with t_{\min} . Essentially, we will require that \emptyset is a big bounce separating two cycles of cosmology, and that it can be reached in the x^0 direction or the χ^4 direction. This fits an interpretation of \emptyset as a black brane or a black hole/white hole pair.¹ Having established this identification of paths in principle, we will examine the evolution of a wavepacket across the unit cell parameterized with the chronological time. The steps of \hat{M}^3 will be taken as $t_0 \rightarrow \widehat{\infty}$, $\widehat{\infty} \rightarrow -\widehat{\infty}$, and $-\widehat{\infty} \rightarrow (t_0 + \Delta t)$.

Given a δ function initial condition at a $t=0$ in \mathcal{H}_0 , a particle subjected only to the free particle Hamiltonian \hat{H}_0 evolves as

$$\psi(x, t) = \begin{cases} \delta(x) & \text{for } t = 0 \\ \sqrt{\frac{m}{2\pi\hbar t}} \exp\left(\frac{-i\pi}{4}\right) \exp\left(\frac{imx^2}{2\hbar t}\right) & \text{for } t > 0 \end{cases} . \quad (1.8.24)$$

When the wavepacket gets to Ω or \emptyset associated with chronological timelike infinity, we have

$$\psi(x, \widehat{\infty}) = \sqrt{\frac{m}{2\pi\hbar\widehat{\infty}}} \exp\left(\frac{-i\pi}{4}\right) \exp\left(\frac{imx^2}{2\hbar\widehat{\infty}}\right) = 0 .^2 \quad (1.8.25)$$

This final state demonstrates an important difference between the wave equation and the heat equation: the wave equation can recover initial conditions by reversing time, but it is impossible to recover the initial conditions by reversing the heat equation. Starting with $\psi(x, -\widehat{\infty}) = 0$ as the initial condition for a final leg of \hat{M}^3 will not result in a recondensed δ function if $\dot{\psi}(x, -\widehat{\infty}) = 0$, which is the present case. To reconstitute a δ function by reverse time Schrödinger evolution from the $\psi=0$ initial condition, a non-vanishing $\dot{\psi}$ initial condition is required. As a matter of simulating this condition with numerical analysis, we should consider the backward difference

¹If the periodicity of x^0 associated with cosmological bouncing sets the x^0 axis as a great circle of a sphere, the periodicity on χ^4 is necessarily more complicated than a second great circle. Great circles of a sphere intersect twice, but we desire that chronos and chiros should intersect at the past and future bounces, and in the present. Scribing this triple intersection onto a sphere gives chiros a character of *chirality* or helicity relative to chronos.

² $\psi=0$ does not satisfy the $\langle\psi|\psi\rangle=1$ probability condition. We might avoid this problem by citing the zero volume of \emptyset in the physical coordinates. Even if ψ did not equal zero, the integral over a pointlike \emptyset singularity would not be equal to unity. However, we might appeal to the changing level of aleph to resolve the point as a volume.

formula approximation for the first derivative:

$$\dot{\psi}(x, t) = \frac{\psi(x, t) - \psi(x, t - \delta t)}{\delta t} . \quad (1.8.26)$$

By imposing the condition that $\psi(x, t - \delta t)$ was non-zero, meaning that the wavefunction did not become identically zero until the last step of a Gaussian integration to infinity, we will obtain a non-zero $\dot{\psi}$ initial condition for the \hat{M}^3 step of $-\widehat{\infty} \rightarrow t_0 + \Delta t$. We will use the \hat{M}^2 step of $\widehat{\infty} \rightarrow -\widehat{\infty}$ to reverse the sign on $\dot{\psi}$. A cursory examination of (1.8.24) shows that $\psi = 0$ for any $t \notin \mathbb{R}^0$, so the \hat{M}^1 step should evolve ψ only to the end of the neighborhood of the origin. Evidently, we are working in the coordinates where $\widehat{\infty}$ is identified with \mathcal{F}_0 , as in Section 1.6.8 (Figure 9). If we identify $\widehat{\infty}$ with the first time beyond time in the neighborhood of the origin, then $\psi(x, t - \delta t) \neq 0$, and the backward difference formula for the derivative will facilitate reconstitution of the δ function beyond infinity. That step will begin with a non-vanishing first derivative.

The method described above will move $\delta(x)$ in \mathcal{H}_0 to $\delta(x)$ in \mathcal{H}_1 . However, the chronological time in \mathcal{H}_1 is $t_0 + \Delta t$. Decoherence occurs in the time interval $(t_0, t_0 + \Delta t)$, so if a detector collapsed the state to $\delta(x)$ at event a , the detector should collapse it to $\delta(x \pm \Delta x)$ at event b . Uncertainty is such that repeated measurements of position should differ somewhat. As a proposal for obtaining the Δx spatial variation needed for agreement with experiments, we will refer to the irrational part of the relative scale between levels of aleph. This is the $2\pi\Phi$ appearing in $\hat{M}^3|\psi; \hat{\pi}^0\rangle = 2\pi\Phi|\psi; \hat{\pi}^1\rangle$ (wherein infinite relative scale may be implicit in $\hat{\pi}^k \rightarrow \hat{\pi}^{k+1}$.) When rescaling the observer's frame onto a new level of aleph as in (1.8.23), and when the scale is an irrational number, we may achieve wavefunction decoherence leading to $\delta(x \pm \Delta x)$ as a novel numerical effect.

Due to an inability to exactly represent irrational numbers as floats, it will not be possible to exactly reverse diffusion in Σ^+ with coalescence in Σ^- when x is altered by an irrational scale factor. For instance, we have shown that the coordinate transformations between the $\{x_+^\mu, x^\mu, x_-^\mu\}$ physical coordinates are all such that the entries in the transformation matrix are real numbers, but the relationship that sets $t = \widehat{\infty}$ as a conformal infinity at $\chi_+^4 = \Phi$ is likely to have a function in it, e.g.:

$$t(\chi_+^4) = \tan\left(\frac{\pi\chi_+^4}{2\Phi}\right) \implies t(\Phi) = \infty . \quad (1.8.27)$$

In turn, the transformation matrix between physical and abstract coordinates will have non-constant function entries whose chain rule properties under differentiation are much different than the static scale factors among the different branes' physi-

cal coordinates. Upon irrational rescaling, the appearance of Φ in the argument of functions periodic in 2π will inevitably require float-precision approximations. The associated rounding error might be useful for producing what QM assigns as stochastics to dynamics in the MCM. $\delta(x)$ in \mathcal{H}_0 will be reconstituted as $\delta(x \pm \Delta x)$ on \mathcal{H}_1 simply due to rounding error even if the Gaussian time steps are exactly reversed. Furthermore, when Φ appears in the periodic argument of functions such as e^x , the accumulation of rounding error across many levels of aleph will never lead to runaway, unphysical solutions because the error will be taken modulo the period. The rounding error pushed through the function's periodicity may lead to behaviors similar to single slit diffraction particles appearing randomly on a scintillation screen. One would attempt to write the correlation function describing the rate of decoherence of a wavefunction between t and $t + \Delta t$ in terms of the rounding error. The language of Lyapunov exponents may be appropriate for such a characterization because chaos is a byproduct of determinism.

1.9 The Fine Structure Constant

Dirac is quoted as saying the origin of the fine structure constant is, “the most important unsolved problem in physics,” and rightly so. The link between electromagnetism, special relativity, and quantum theory given by the inclusion of e , c , and \hbar in

$$\alpha_{\text{QED}} = \frac{e^2}{4\pi\epsilon_0\hbar c} \quad , \quad (1.9.1)$$

is a tantalizing hint of some fundamental unification which has escaped detection in prevailing theories. In that vein, Feynman wrote the following [87].

“It is a simple number that has been experimentally determined to be close to 0.08542455. (My physicist friends won't recognize this number, because they like to remember it as the inverse of its square: about 137.03597 with about an uncertainty of about 2 in the last decimal place. It has been a mystery ever since it was discovered more than fifty years ago, and all good theoretical physicists put this number up on their wall and worry about it.) Immediately you would like to know where this number for a coupling comes from: *is it related to pi* [*emphasis added*] or perhaps to the base of natural logarithms? Nobody knows. It's one of the greatest damn mysteries of physics: a magic number that comes to us with no understanding by man. You might say the ‘hand of God’ wrote that number, and ‘we don't know how He pushed his pencil.’ We know what kind of a dance to do

experimentally to measure this number very accurately, but we don't know what kind of dance to do on the computer to make this number come out, without putting it in secretly!"

The MCM value for the fine structure constant (FSC) is very much "related to pi":

$$\alpha_{\text{MCM}}^{-1} = 2\pi + (\Phi\pi)^3 \approx 137 \quad . \quad (1.9.2)$$

The original motivation for \hat{M}^3 in [30] was nothing more than a requirement to generate the $(\Phi\pi)^3$ term in α_{MCM}^{-1} . The other context for \hat{M}^3 and $\hat{\Upsilon} = \hat{\mathcal{U}} + \hat{M}^3$ was reverse engineered from that. (Appendix A reviews the original ideation for \hat{M}^3 .) Since the subsequent introduction of the chirological variables has called into question the $\partial_x + \partial_t^3$ structure of

$$\hat{\Upsilon}|\Psi_\alpha\rangle = (\partial_x + \partial_t^3)|\Psi_\alpha\rangle = \alpha_{\text{MCM}}^{-1}|\Psi_\alpha\rangle \quad , \quad (1.9.3)$$

in this section we will use $\hat{\alpha}$ such that

$$\hat{\alpha}|\Psi_\alpha\rangle = \alpha_{\text{MCM}}^{-1}|\Psi_\alpha\rangle \quad . \quad (1.9.4)$$

Then we will return to $\hat{\Upsilon}$ in Section 1.11 to discuss its simultaneous roles regarding α_{MCM} and total evolution combining the chronological and chirological evolution operators $\hat{\mathcal{U}}$ and \hat{M}^3 . A 0.4% discrepancy between α_{MCM} and α_{QED} is discussed in Section 1.9.4.

1.9.1 Fine Structure in the Unit Cell

The best way to find a place for $\hat{\alpha}$ and/or its eigenstate might begin with a survey of physics' existing roles for α_{QED} : the electron $g - 2$, the Josephson junction, Sommerfeld's work regarding the *fine structure* splitting of atomic energy levels, etc. For each given context, one would seek to amend existing relationships and interpretations with principles unique to the MCM.

The most elementary physical statement of the FSC is the ratio of two energies: the energy E_{ee} needed to close the distance d between two electrons and the energy E_γ of a photon with wavelength $\lambda = 2\pi d$:

$$\frac{E_{ee}}{E_\gamma} = \frac{\left(\frac{e^2}{4\pi\epsilon_0 d}\right)}{\left(\frac{hc}{2\pi d}\right)} = \frac{e^2}{4\pi\epsilon_0 \hbar c} = \alpha \quad . \quad (1.9.5)$$

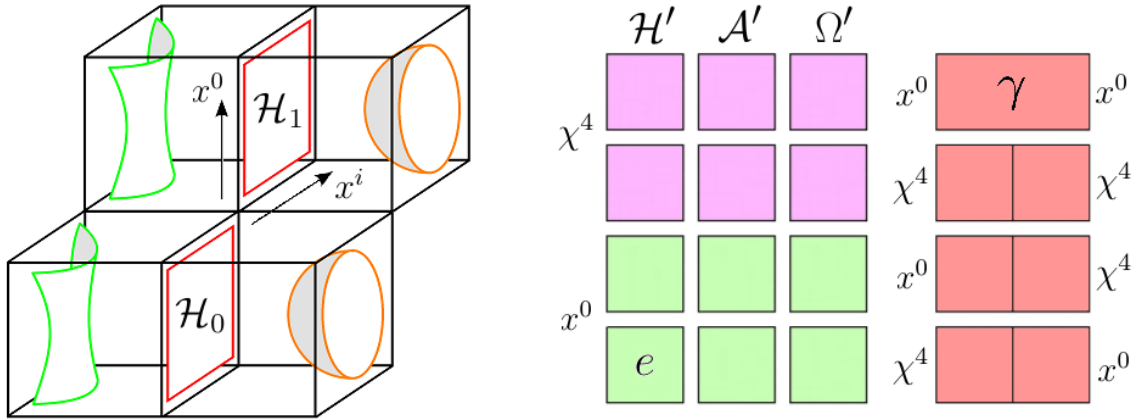

Figure 13: On the right, MCM fundamental matter particles are quanta of spacetime spanned by x^i (space) and either of x^0 or χ^4 (time). MCM fundamental bosons are constructed as connections of matter particles. On the left, the objects of the unit cell are easily parsed as two electrons and a photon. Each \mathcal{H} -brane is an $x^0 x^i$ quantum associated with the electron, and the photon is formed as the union of two $x^0 x^i$ quanta. The pictured arrangement of the unit cell emphasizes the chronological continuity of x^0 between \mathcal{H}_0 and \mathcal{H}_1 .

The MCM particle scheme in Figure 13 (also Section 0.3) is such that electrons are quanta of spacetime spanned by x^i and x^0 . Photons are constructed from pairs of such quanta. Therefore, the E_{ee}/E_γ definition of α suggests the ratio of the energy between two \mathcal{H} -branes to the energy of a complete unit cell. As in Section 1.4 regarding MCM spin spaces, the $\{\mathcal{A}, \mathcal{H}, \Omega\}$ structure is evocative of the three spin states afforded to photons. Even the $\{\Sigma^+, \emptyset, \Sigma^-\}$ structure suggests the massless photon's restriction to two polarization directions. Work is required to develop the MCM particle scheme to the point where more concrete statements can be made regarding the E_{ee}/E_γ ratio.

Furthermore, the hydrogen atom's electron and three nuclear quarks may be matched with an $x^0 x^i$ quantum and three $\{+, \emptyset, -\}$ variants of the $\chi^4 x^i$ spacetime quantum. Since the hydrogen atom is foremost among α 's physical settings, one would study the cases for the association of hydrogen's constructive elements with the structure of the unit cell. Particularly, we have associated the subscripting on χ^4 with QCD color charge, so the up-up-down quark construction of the proton does not precisely match the three variants of χ^4 . Instead, the particle scheme is such that the proton is constructed as two right-handed $\chi^4 x^i$ spacetimes, and one left-handed. The intuitive association in Figure 13 is that the Σ^\pm between two \mathcal{H} -branes combine with another instance of Σ^+ or Σ^- such that one has opposite helicity to the other two.

Such issues remain to be studied and developed. Particularly, the introduction of $\widehat{\infty}$ following the initial formulation of the MCM particle scheme in [6] is such that we might differentiate pairs of leptons or quarks as triads being anchored at the origin $\widehat{0}$ or at $\widehat{\infty}$ which functions as the origin of a neighborhood of infinity. In this way, the uud nucleon structure might be associated with \emptyset attached to $\widehat{0}$ and each of \mathcal{A}, Ω attached to $\pm\widehat{\infty}$. A polar model of the unit cell as a 5D sphere whose radial direction is χ^4 is also in order.

1.9.2 The Fine Structure Constant as an Eigenvalue

The FSC is observable, so it should be the real eigenvalue of a Hermitian operator $\hat{\alpha}$. An ansatz for $\hat{\alpha}$ is

$$\hat{\alpha} = (i\partial_0) + (i\partial_4)^3, \quad (1.9.6)$$

where

$$i\partial_0|\Psi_\alpha\rangle = 2\pi|\Psi_\alpha\rangle, \quad \text{and} \quad (i\partial_4)^3|\Psi_\alpha\rangle = (\Phi\pi)^3|\Psi_\alpha\rangle. \quad (1.9.7)$$

The $i\partial$ operator is a sign conjugated momentum operator in the position representation or a position operator in the momentum representation. Such operators are Hermitian, and the sum of two Hermitian operators is Hermitian.¹ It follows that $\hat{\alpha}$ is Hermitian. Its eigenvalue $2\pi + (\Phi\pi)^3$ is real, so $\hat{\alpha}$ meets QM's minimum requirements for the operator representation of an observable.

Given the proposed form of $\hat{\alpha}$, the eigenstate with eigenvalue α_{MCM}^{-1} is

$$\Psi_\alpha(x^0, \chi^4) = \exp\{-i(2\pi x^0 + \Phi\pi\chi^4)\}. \quad (1.9.8)$$

The particle-in-a-box wavefunction used for Ψ_α in [3, 30] was not an eigenstate of $\hat{\alpha}$, but a former trivial deficiency is remedied in (1.9.8). Still, it remains to find the meaning of this Ψ_α state. Since it is our desire to associate the FSC with the structure of the unit cell, we should consider the case in which Ψ_α is a plane wave whose wave vector \mathbf{k} or k_μ is an MCM reciprocal lattice vector in the MCM direct lattice. The case in which Ψ_α is the state of the lattice rather than a state subjected to the lattice's regularity structure must be considered. Association of Ψ_α with the lattice itself will motivate a context for the \hat{Y} total evolution operator to return a universal eigenvalue when it acts on Ψ_α . We will return to \hat{Y} in Section 1.11.²

¹Since the momentum operator is defined on an infinite-dimensional Hilbert space, the Hermiticity condition $\hat{O} = \hat{O}^\dagger$ is technically replaced with a broader condition of self-adjointness. This condition requires that operation to the right and operation to the left with the conjugate transpose produce the same result.

²A Schrödinger equation for the identity operator was an idea for the origin of α which was omitted from this book because it could not be quickly developed. However, one might attempt to write a Schrödinger equation for the identity operator to characterize changing scale from one brane to the next. This exercise would be guided by the intention to associate α_{MCM} with the changing level of aleph.

1.9.3 Plane Waves

The fine structure constant should be a characteristic value associated with the unit cell. Per Section 1.7.3, plane wave states bounded in a finite region are written as

$$\phi_j(\mathbf{r}) = \frac{e^{i\mathbf{k}_j \cdot \mathbf{r}}}{\sqrt{V}} \quad , \quad (1.9.9)$$

where \mathbf{k}_j is the j^{th} quantized wavenumber allowed by the finite boundary conditions. Although we expect $(\Phi\pi)^3$ to come from a third derivative, the V dependence in ϕ_j gives a hint of what is needed for α_{MCM} . $(\Phi\pi)^3$ is the volume of a 3D box whose sides have length $\Phi\pi$. The volume interpretation is interesting and deserving of further study because $\hat{\pi}$ and $\hat{\Phi}$ are associated with the \mathcal{H} and Ω bounding branes of Σ^+ while the \mathcal{A} and \mathcal{H} bounding branes of Σ^- are associated with $\hat{2}$ and $\hat{\pi}$. This association of 2 and π in Σ^- , and Φ and π in Σ^+ is oddly similar to the arrangement of numbers in $2\pi + (\Phi\pi)^3$. However, the association of V with α_{MCM} does not directly relate to an operator eigenvalue $\hat{\alpha}|\Psi_\alpha\rangle = \alpha^{-1}|\Psi_\alpha\rangle$, apparently. Instead, the volume would show up in the allowed quantized \mathbf{k}_j associated with ∂_x acting on ϕ_j . The discrete \mathbf{k}_j and ω_j are

$$\mathbf{k}_j = 2\pi \left(\frac{j_x}{L_x}, \frac{j_y}{L_y}, \frac{j_z}{L_z} \right) \quad , \quad \text{and} \quad \omega_j = \frac{k_j^2}{2\hbar\mu} \quad , \quad (1.9.10)$$

and we might expect some quantized spectrum for β in the MCM ansatz

$$\psi_j(\mathbf{x}, t, \chi^4) = \exp\{i(\mathbf{k}_j \cdot \mathbf{x} - \omega_j t + \beta_j \chi^4)\} \quad , \quad (1.9.11)$$

where j becomes a tuple of five integers. Quantization in β would follow from the unit cell's boundary conditions along the χ^4 direction.

Considering (1.9.11), spatial derivatives hitting \mathbf{x} will produce a sum of three analytical terms not compatible with α_{MCM} . The original use case for ∂_x in [30] relied on a reduction to one spatial dimension (Appendix A), but the gradient acting on a 3D spatial wavefunction will return three summed factors of 2π , two of which do not appear in α_{MCM}^{-1} . This suggests that $\hat{\alpha}$ should be a combination of ∂_0 and ∂_4 , or a combination of $\{\partial_+, \partial_\emptyset, \partial_-\}$ derivatives. Allowable forms for $\hat{\alpha}|\Psi_\alpha\rangle$ include

$$\hat{\alpha}|\Psi_\alpha\rangle = i(\partial_0 + \partial_4)e^{i(\mathbf{k}_j \cdot \mathbf{x} - 2\pi t - \Phi\pi\chi^4)} = 2\pi + (\Phi\pi)^3 \quad , \quad (1.9.12)$$

and

$$\hat{\alpha}|\Psi_\alpha\rangle = i(\partial_- - \partial_+^3)e^{i(\mathbf{k}_j \cdot \mathbf{x} - \omega_j t - 2\pi\chi_-^4 + \Phi\pi\chi_+^4)} = 2\pi + (\Phi\pi)^3 \quad . \quad (1.9.13)$$

Following the program of the particle in a box developed in [3, 30], one would deter-

mine which geometries are consistent with a given quantization for ω and β . However, a problem which remains will be an unbounded quantization spectrum leading to an infinite tier of eigenvalues for α . Experiment does not suggest that the FSC is only one dimensionless number from a large catalog of such numbers. At best, $\alpha_{\text{MCM}} \approx \alpha_{\text{QED}}$ is one of three or four dimensionless coupling constants, the others being α_{Weak} , α_{Strong} , and possibly the numerically disparate α_{Grav} .

1.9.4 Disagreement Between α_{MCM} and α_{QED}

The L3 Collaboration writes the following [88].

“At zero momentum transfer, the QED fine structure constant $\alpha(0)$ is very accurately known from the measurement of the anomalous magnetic moment of the electron and from solid-state physics measurements:

$$\alpha^{-1}(0) = 137.03599976(50) . \quad (1.9.14)$$

In QED, vacuum polarization corrections to processes involving the exchange of virtual photons result in a Q^2 dependence, or running, of the *effective* fine-structure constant, $\alpha(Q^2)$.”

Figure 14 shows that α_{QED}^{-1} tends to decrease with increasing energy, so it is notable that

$$\alpha_{\text{MCM}}^{-1} = 2\pi + (\Phi\pi)^3 \approx 137.62788 , \quad (1.9.15)$$

is higher even than what the L3 Collaboration have called $\alpha^{-1}(0)$:

$$\alpha^{-1}(0) - \alpha_{\text{MCM}}^{-1} \approx -0.59 . \quad (1.9.16)$$

Therefore, it must be noted that the energy of scale of a process is not absolute. It depends on the renormalization scheme as well as the manner of association between Q^2 and the Mandelstam variables, as in Figure 15. It is a common convention to set the energy scale of α_{QED} to the rest energy of the electron $E_e = 511\text{keV}$ so that

$$\alpha_{\text{QED}} \equiv \alpha(0) \quad \longrightarrow \quad \alpha_{\text{QED}} \equiv \alpha(E_e^2) = \frac{e^2}{4\pi\epsilon_0\hbar c} . \quad (1.9.17)$$

This allows us to suppose that $\alpha_{\text{MCM}}^{-1} > \alpha_{\text{QED}}^{-1}$ might be the true $\alpha^{-1}(0)$. Though the small scale of keV relative to the GeV scale in Figure 14 suggest that α_{MCM} probably does not lie on the linear trend of the standard model, the kinks at low energy the end of the supersymmetric standard model suggest that the uncharted low energy

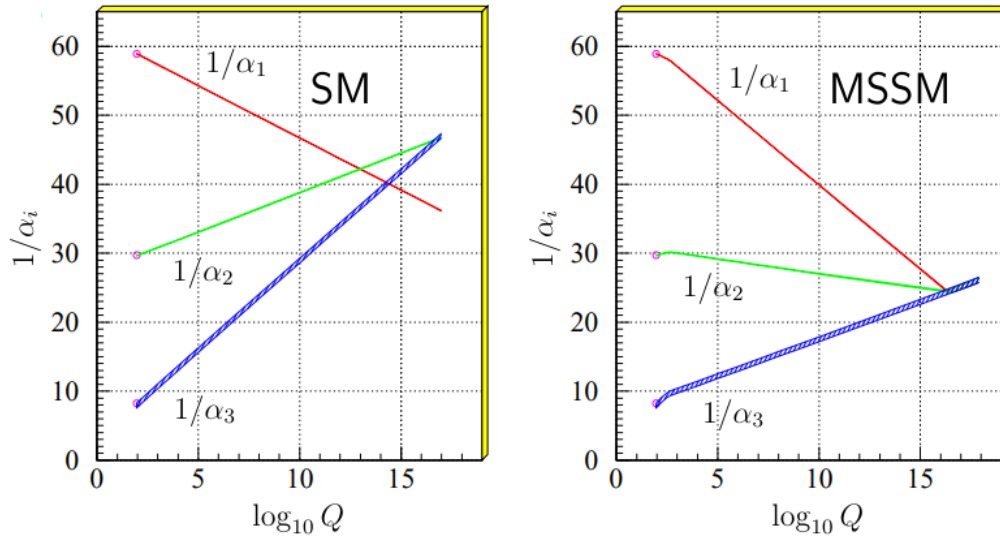

Figure 14: This figure shows an updated plot of Amaldi, de Boer, and Fürstenau [89]. In units natural to high energy physics, the α_i plotted here are the electromagnetic, weak, and strong coupling constants respectively. The standard model (left) nearly unifies the coupling constants of the forces, but the (minimal) supersymmetric standard model (right) exactly unifies them at a given energy scale. These famous plots refute any detractors' claims about indisputable precision in the currently accepted value of α_{QED} ruling out a physical basis for α_{MCM} .

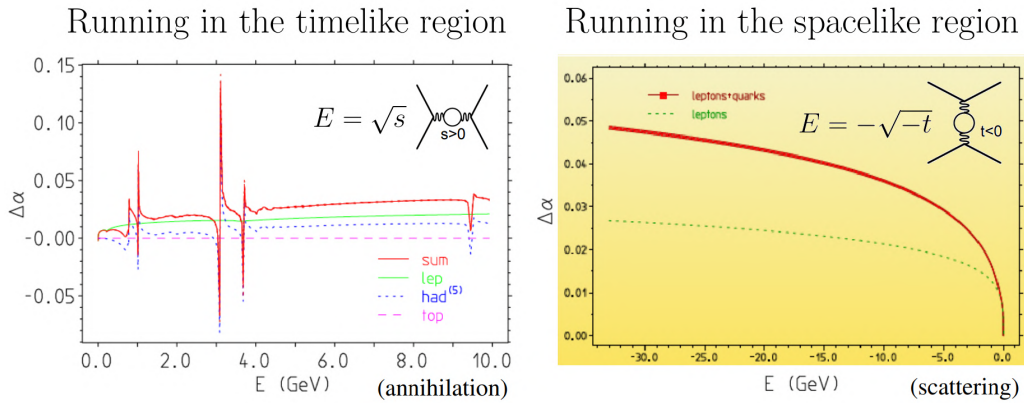

Figure 15: Plots of $\Delta\alpha$ vs E are taken from a seminar of Venanzoni [90] regarding results from the KLOE collaboration [91]. The s and t variables are the usual Mandelstam variables for particle scattering. With time increasing to the right in the inset particle diagrams, one observes that the exchanged photon moves through the timelike and spacelike regions in the respective interactions.

region might accommodate α_{MCM} as a value not on the trend line. Since the units of Figure 14 are not ones in which $\alpha_{\text{QED}}^{-1} \approx 137$, a calculation is required to determine whether even the accepted constant lies on the trend line.

Several measurements of the running of α suggest that α_{MCM} is a reasonable number. The main results of the L3 collaboration reported in [88] were

$$\begin{aligned} \alpha^{-1}(-2.1) - \alpha^{-1}(-6.25) &= 0.78 \pm 0.26 & (\Delta Q^2 = 4.15) & \quad (1.9.18) \\ \alpha^{-1}(-12.25) - \alpha^{-1}(-3435) &= 3.80 \pm 1.29 & (\Delta Q^2 = 3422) & \quad , \end{aligned}$$

where Q^2 is in units of GeV^2 . Referring to (1.9.16), one notes that

$$0.59 < 0.78 < 3.80 \quad . \quad (1.9.19)$$

This suggests the Q^2 difference between α_{MCM} and α_{QED} is less than 4GeV^2 . This agrees with the supposition for $\alpha_{\text{MCM}} \equiv \alpha(0)$ and $\alpha_{\text{QED}} \equiv \alpha(E_e^2)$, if it isn't a bit larger than would be expected. The result reported by the OPAL collaboration in [92] was

$$\Delta\alpha(-6.07) - \Delta\alpha(-1.81) \approx 0.0044 \quad (\Delta Q^2 = 4.26) \quad . \quad (1.9.20)$$

Using

$$\alpha(Q^2) = \frac{\alpha(0)}{1 - \Delta\alpha(Q^2)} \quad , \quad (1.9.21)$$

(given in [88]) to compute

$$\Delta\alpha_{\text{QED}} = 1 - \frac{\alpha_{\text{MCM}}}{\alpha_{\text{QED}}} \approx 0.0043 \quad , \quad \text{and} \quad \Delta\alpha_{\text{MCM}} = 0 \quad , \quad (1.9.22)$$

we find

$$\Delta\alpha_{\text{QED}}^{-1} - \Delta\alpha_{\text{MCM}}^{-1} \approx 0.0043 \quad . \quad (1.9.23)$$

OPAL's result also fits the present picture of α_{MCM} . In [91], the KLOE collaboration reports a measurement in the low energy region omitted from Figure 14. They find

$$\left| \frac{\alpha(Q_{\text{avg}}^2)}{\alpha(0)} \right|^2 \approx 1.029 \quad , \quad \text{for} \quad 0.605\text{GeV} \leq Q \leq 0.975\text{GeV} \quad .^1 \quad (1.9.24)$$

Comparing to the present model, we find

$$\left| \frac{\alpha_{\text{QED}}}{\alpha_{\text{MCM}}} \right|^2 \equiv \left| \frac{\alpha(E_e^2)}{\alpha(0)} \right|^2 \approx \left| \frac{137.03600^{-1}}{137.62788^{-1}} \right|^2 = 1.009 \quad . \quad (1.9.25)$$

¹This value is averaged from Table 2 in [91].

So, while the discrepancy between α_{MCM} and α_{QED} might have seemed high, KLOE reports much greater running in the low energy region than might be intuited from the results of the L3 and OPAL collaborations [88, 92], or from Figure 14 [89]. In addition to the mild kinks at the low energy range of the supersymmetric model and the wide running observed by KLOE, the sharp resonance structure observed for α running in the timelike region (Figure 15) might easily accommodate the present supposition for α_{MCM} .

The MCM value for the fine structure constant is well within the experimental bounds. The fact that $\alpha_{\text{MCM}}^{-1} > \alpha_{\text{QED}}^{-1}$ is well fitting to the theme of the MCM. Since the running of the fine structure constant is associated with an *effective* charge on the electron due to screening by vacuum polarization, a hypothetical $\alpha_{\text{MCM}}^{-1} < \alpha_{\text{QED}}^{-1}$ would force us to associate α_{MCM} with some effective $\alpha(Q^2)$ not well suited to the desired absoluteness of a fundamentally *ontological* picture. As it is, however, $\alpha_{\text{MCM}}^{-1} > \alpha_{\text{QED}}^{-1}$ allows to choose $\alpha_{\text{MCM}} = \alpha(0)$ as the perfect, non-effective value that one might associate with an underlying geometric structure of reality.

Overall, the main purpose of this section has been to refute detractors' claims that high precision in the currently accepted value of α_{QED} categorically rules out a physical basis for α_{MCM} . To that end, the following relevant excerpts appear in a publication of NIST [93] and a publication of Fritzsche [94].

“Indeed, due to e^+e^- and other vacuum polarization processes, at an energy corresponding to the mass of the W boson (approximately 81 GeV, equivalent to a distance of approximately 2×10^{-17} m), $\alpha(m_W)$ is approximately 1/128 compared with its zero-energy value of approximately 1/137. Thus the famous number 1/137 is not unique or especially fundamental.”

“[A]t energies which were reached by the LEP–Accelerator,¹ of the order of 200 GeV, the associated value of the finestructure constant is more than 10% higher than at low energy. In any case this signifies that one should not attach a specific fundamental meaning to the numerical value of the finestructure constant.”

These sources state what all subject matter experts already knew: detractors' citations to the 0.4% FSC discrepancy as conclusive evidence of terminal wrongness are nothing but the libelous vomit of those who would prey on the non-expertise of certain third parties.²

¹These results are found in [88].

²An example of such third parties would be the ones for whom Ellis and You concocted their lie about “reasonable doubt” in [28].

1.9.5 Grand Unification

The variation of the fundamental coupling constants is the matter at the heart of the grand unification of fundamental forces which the MCM hopes to achieve, as in Figure 14. In addition to seeking unification of the coupling constants at a given energy scale, now we might explore cases for all three $\alpha_i(0)$ to fall out of the ontological numbers combined with the geometry of the unit cell. Even the fourth coupling constant for gravity which is omitted from grand unification due to its vastly disparate scale (the hierarchy problem) might now be studied as a characterization of the changing scale from one level of aleph to another.

1.10 Quantum Gravity

1.10.1 Einstein's Equation

There are a few equations which can be used to initiate the MCM route to Einstein's equation. The original route in [3] was as follows. Suppose that the third chronological time derivative of the ansatz

$$\psi(x, t, \chi^4) = \exp\{i(kx - \omega t + \beta\chi^4)\} \quad , \quad (1.10.1)$$

is equal to the translation operator definition of \hat{M}^3 (Section 1.7.1):

$$\begin{aligned} \hat{M}^3|\psi; \hat{\pi}\rangle &= \hat{M}^3|\psi; \hat{\pi}\rangle \\ \partial_0^3|\psi; \hat{\pi}\rangle &= \hat{\mathcal{J}}_- \hat{\mathcal{J}}_\emptyset \hat{\mathcal{J}}_+ |\psi; \hat{\pi}\rangle \\ (-i\omega)^3|\psi; \hat{\pi}\rangle &= 2\pi\Phi|\psi; \hat{\pi}\rangle \\ 8i\pi^3\nu^3|\psi; \hat{\pi}\rangle &= 2\pi|\psi; \hat{\pi}\rangle + 2\pi\varphi|\psi; \hat{\pi}\rangle \quad .^1 \end{aligned} \quad (1.10.2)$$

The final line follows from $\Phi = 1 + \varphi$. In Section 1.10.3, we will give a new, better motivation for operating differently with \hat{M}^3 on the left and right sides of (1.10.2). The purpose here, however, is to present the mechanism as it appeared previously.

In earlier sections, we discussed two different cases of orthogonality for MCM states. First, wavefunctions in each unit cell might be orthogonal from those in other unit cells. Separating the scale factor to maintain $\langle\psi|\psi\rangle = 1$, this condition is written

$$\langle\psi; \hat{e}_\mu^m|\psi; \hat{e}_\nu^n\rangle = \delta_{mn} \|\hat{e}_\mu^m\| \|\hat{e}_\nu^n\| \quad , \quad (1.10.3)$$

¹In [3], the convention was such that $\hat{M}^3|\psi; \hat{\pi}^1\rangle = i\pi\Phi^2|\psi; \hat{\pi}^2\rangle$ rather than the current convention for $\hat{M}^3|\psi; \hat{\pi}^0\rangle = 2\pi\Phi|\psi; \hat{\pi}^1\rangle$.

where m, n refer to the level of aleph. The other picture of orthogonality sets wave-functions in each brane orthogonal from those in every other brane:

$$\langle \psi; \hat{e}_\mu^m | \psi; \hat{e}_\nu^n \rangle = \delta_{\mu\nu} \delta_{mn} \|\hat{e}_\mu^m\| \|\hat{e}_\nu^n\| \quad . \quad (1.10.4)$$

If we are to proceed as in [3], it is required that we adopt the former convention of (1.10.3). The variants of ψ located in the \mathcal{A} -, \mathcal{H} -, or Ω -branes of any one unit cell cannot be linearly independent from each other. Linear dependence allows us to proceed from (1.10.2) by inserting the identity and rearranging the hats:¹

$$\begin{aligned} 8i\pi^3 \nu^3 |\psi; \hat{\pi}\rangle &= 2\pi \frac{\|\hat{\Phi}\|}{\|\hat{\Phi}\|} |\psi; \hat{\pi}\rangle + 2\pi\varphi \frac{\|\hat{2}\|}{\|\hat{2}\|} |\psi; \hat{\pi}\rangle \\ 8i\pi^3 \nu^3 |\psi; \hat{\pi}\rangle &= \frac{2\pi\|\hat{\pi}\|}{\Phi} |\psi; \hat{\Phi}\rangle + \frac{2\pi\varphi\|\hat{\pi}\|}{2} |\psi; \hat{2}\rangle \\ 8\pi i \Phi \nu^3 |\psi; \hat{\pi}\rangle &= 2|\psi; \hat{\Phi}\rangle + |\psi; \hat{2}\rangle \quad . \end{aligned} \quad (1.10.5)$$

Due to the constant 8π appearing at the end of (1.10.5), and due to that alone, the resultant expression was recognized to be in the form of Einstein's equation

$$8\pi T_{\mu\nu} = G_{\mu\nu} + g_{\mu\nu} \Lambda \quad . \quad (1.10.6)$$

(The overall research program leading to the final line of (1.10.5) is summarized in Section 1.10.7.) Recasting (1.10.5) as Einstein's equation requires the introduction of new variables:

$$\begin{aligned} i\Phi \nu^3 |\psi; \hat{\pi}\rangle &\rightarrow T_{\mu\nu} \\ 2|\psi; \hat{\Phi}\rangle &\rightarrow G_{\mu\nu} \\ |\psi; \hat{2}\rangle &\rightarrow g_{\mu\nu} \Lambda \quad . \end{aligned} \quad (1.10.7)$$

Substitution of these variables back into the final line of (1.10.5) yields (1.10.6).

The interpretation of this result is that general relativity describes a condition in which the present is the sum of the past and the future. Intuitively, we have the stress-energy tensor $T_{\mu\nu}$ associated with the \mathcal{H} -brane. Less intuitively, the Einstein tensor $G_{\mu\nu}$ is associated with Ω , and the cosmological constant is attached to \mathcal{A} . The meaning of $T_{\mu\nu} \in \mathcal{H}$ is clear enough, but the meanings of the other assignments are

¹This procedure for rearranging hats follows (1.2.22) in Section 1.2.1.

not obvious. Furthermore, we have arbitrarily chosen the entire Einstein tensor

$$G_{\mu\nu} \equiv R_{\mu\nu} - \frac{R}{2}g_{\mu\nu} \quad , \quad (1.10.8)$$

for association with Ω when we might have let $\Lambda \rightarrow 0$ and assigned the Ricci tensor and the Ricci scalar to Ω and \mathcal{A} through maps other than those in (1.10.7). We have also assumed that the new variables are in one-to-one correspondence with the states rather than with their linear combinations.

The desire to phrase general relativity as a statement of the present being equal to a sum a contributions from the past and future is confounded (or complicated) when we include an iterator for the level of aleph:

$$\hat{M}^3|\psi; \hat{\pi}\rangle = 2\pi\Phi|\psi; \hat{\pi}\rangle \quad \longrightarrow \quad \hat{M}^3|\psi; \hat{\pi}^k\rangle = 2\pi\Phi|\psi; \hat{\pi}^{k+1}\rangle \quad . \quad (1.10.9)$$

With the k iterators, Einstein's equation tells us that the present on one level of aleph is equal to a sum of contributions from the past and future relative to some time in the future. Unfortunately, this interpretation is much less clean than what can be said in the absence of the iterators. To make better sense of the place for Einstein's equation, we must first refer to the picture of MCM cosmology states which have gone untreated thus far.

1.10.2 MCM Cosmology States

Even before the MCM particle scheme was introduced to solve the fundamental problem of QFT (Section 0.3) [6], the universe was treated as a quantum particle to resolve another question about why matter dominates over anti-matter in the cosmos [31]. Upon introducing a reverse time universe in fulfillment of a requirement for conserved momentum at a big bang (or big bounce), an eigenbasis of **quantum cosmology states** was defined for a time arrow operator [40]:

$$\begin{aligned} \hat{T}|t_+\rangle &= |t_+\rangle \\ \hat{T}|\text{bounce}\rangle &= 0 \\ \hat{T}|t_-\rangle &= -|t_-\rangle \quad . \end{aligned} \quad (1.10.10)$$

$|t_+\rangle$ is the state of a universe U_+ whose time arrow is such that the energy of that universe is positive-definite. $|t_-\rangle$ is the state of U_- whose energy is negative-definite. $|\text{bounce}\rangle$ is the state of U_{\pm} simultaneously collapsed to a singularity.¹ An observer's

¹In the MCM's original big bounce treatment [31, 40], $|\text{bounce}\rangle$ referred to the apex of a "quantum geometric

inability to distinguish $|t_{\pm}\rangle$ led to the $|t_{\star}\rangle$ superposition as the observer’s present moment. In quantum theory, ignorance about eigenstates is represented with superpositions of eigenstates, as is the case for Schrödinger’s cat. The observer writes

$$|t_{\star}\rangle = |t_{+}\rangle + |t_{-}\rangle \quad , \quad (1.10.11)$$

when he is unable to determine if his present moment belongs to a positively or negatively increasing continuum of time. The $|t_{\star}\rangle = |t_{+}\rangle + |t_{-}\rangle$ relationship is important for MCM electrogravity (Section 18) and the connection of the unit cell to KKT (Section 17) [7]. A simple statement of what it means for the present to be defined as the sum of components from the past and future is found in the definition

$$A^{\mu} = \frac{1}{2}A_{\mu}^{+} + \frac{1}{2}A_{\mu}^{-} \quad . \quad (1.10.12)$$

This says that the EM potential 4-vector A_{μ} in \mathcal{H} is defined by A_{μ}^{\pm} in Σ^{\pm} (Section 16) [7]. The metric in \mathcal{H} defined as a superposition of g_{AB}^{\pm} as $\chi_{\pm}^4 \rightarrow 0$ is another example. The exact details of these dependencies remain to be worked out, but we have clarified what it means for the present to be defined as a sum of contributions from the past and future.

The MCM supposes that a cosmogenesis bounce event is equivalent to spontaneous pair creation in the quantum vacuum.¹ In [40], the $\widehat{\text{MCM}}$ operator was introduced to affect this pair creation as

$$\widehat{\text{MCM}}|\text{bounce}\rangle = |t_{+}\rangle + |t_{-}\rangle \quad .^2 \quad (1.10.13)$$

The fourth time state $|t_{\star}\rangle$ is like a state in a Hilbert space of states at time t_0 corresponding to the present. Due to certain likenesses between the singular present moment and the singular apex of a big bounce, the present was identified with the bounce as

$$|t_{\star}\rangle \equiv |\text{bounce}\rangle \quad \implies \quad \hat{T}|t_{\star}\rangle = 0 \quad . \quad (1.10.14)$$

Thus, the convergence of U_{\pm} on the bounce was associated with the convergence of the past and future on the present. Subsequent work now suggests that the $|t_{\star}\rangle$ and

bounce” rather than a true singularity. However, the language of quantum geometry has since been deprecated in the MCM. The original formulation made an appeal to Ashtekar’s “repulsive force of quantum geometry” [58] to avoid total topological collapse at the bounce, but it is likely that Ashtekar’s avoidance of total collapse was only an artifact of his numerical algorithms, in the opinion of this writer. Presently, we *do* associate \emptyset with a topological singularity of infinite curvature.

¹A pair of universes coming into existence spontaneously is like pair creation in the vacuum while the total bounce process for a crunch followed by a bang is like annihilation to a photon followed by $\gamma \rightarrow e + p$.

²The $\widehat{\text{MCM}}$ operator was called \widehat{LQC} in [40].

$|\text{bounce}\rangle$ cosmology states should be associated with the \mathcal{H} - and \emptyset -branes respectively, and the $|t_\star\rangle \neq |\text{bounce}\rangle$ structure is preferable for a number of reasons. For one, it avoids an implied identification between a spatially extended present moment and a non-extended big crunch singularity. Whether or not we identify the bounce with the present, we must reconcile

$$|t_\star\rangle = |t_+\rangle + |t_-\rangle \quad , \quad \text{and} \quad \widehat{\text{MCM}}|t_\star\rangle = |t_+\rangle + |t_-\rangle \quad (1.10.15)$$

where the latter mimics (1.10.13) to say that we must be able to obtain past and future states from a state in the present. The equations in (1.10.15) can only be consistent if $\widehat{\text{MCM}}$ is the identity operator, which is not *exactly* the intended meaning. In this section, we will show that $\widehat{\text{MCM}}$ is a new completeness relation. Such relations are inserted into expressions as the identity.

The $|t_\pm\rangle$ states were originally associated with the positive and negative x^0 modes needed to conserve momentum at the big bang, but subsequent work allows us to associate them with χ_\pm^4 . Moving in that direction, we will define a separate chirological time arrow operator

$$\begin{aligned} \hat{\mathcal{T}}|\chi_+^4\rangle &= |\chi_+^4\rangle \\ \hat{\mathcal{T}}|\chi_\emptyset^4\rangle &= 0 \\ \hat{\mathcal{T}}|\chi_-^4\rangle &= -|\chi_-^4\rangle \quad . \end{aligned} \quad (1.10.16)$$

with a complete set of eigenstates:

$$\mathbb{1} = \sum_k |\chi_k^4\rangle\langle\chi_k^4| \quad , \quad \text{where} \quad k \in \{+, \emptyset, -\} \quad . \quad (1.10.17)$$

When $\hat{\mathcal{T}}$ replaces \hat{T} as it appears in (1.10.10) and we identify $|\text{bounce}\rangle \equiv |\chi_\emptyset^4\rangle \neq |x^0\rangle$, we avoid a degeneracy of the 0 eigenvalue between $|t_\star\rangle$ and $|\text{bounce}\rangle$. Instead, they are eigenstates of different operators reflecting different physical conditions. The chronological time cannot exist at all in a singularity such as $|\text{bounce}\rangle$ because time and space are condensed to a point. On the other hand, we are well motivated to have χ_\emptyset^4 already defined at the singularity because it is an abstract coordinate. (Recall that the singularity is associated with the embedded physical metric, not the 5D metric.)

The \hat{T} time arrow states may be connected to the ontological states as

$$\left. \begin{array}{l} |t_+\rangle \equiv |x_+^0\rangle = |\psi; \hat{\Phi}\rangle = |\psi; \Omega\rangle \\ |t_\star\rangle \equiv |x^0\rangle = |\psi; \hat{\pi}\rangle = |\psi; \mathcal{H}\rangle \\ |t_-\rangle \equiv |x_-^0\rangle = |\psi; \hat{2}\rangle = |\psi; \mathcal{A}\rangle \end{array} \right\} \implies \begin{array}{l} \hat{T}|\psi; \hat{\Phi}\rangle = |\psi; \hat{\Phi}\rangle \\ \hat{T}|\psi; \hat{\pi}\rangle = 0 \\ \hat{T}|\psi; \hat{2}\rangle = -|\psi; \hat{2}\rangle \end{array} , \quad (1.10.18)$$

but it remains to be determined if t_\pm are the past and future of $x^0 \in \mathcal{H}$, if they are $x_+^0 \in \Omega$ and $x_-^0 \in \mathcal{A}$, or if these possibilities are the same. If we use the ontological basis conventions in (1.10.18), the chirological states must have some other identities:

$$\left. \begin{array}{l} |t_+\rangle \equiv |\chi_+^4\rangle = |\psi; \Sigma^+\rangle \\ |\text{bounce}\rangle \equiv |\chi_\emptyset^4\rangle = |\psi; \emptyset\rangle \\ |t_-\rangle \equiv |\chi_-^4\rangle = |\psi; \Sigma^-\rangle \end{array} \right\} \implies \begin{array}{l} \hat{\mathcal{T}}|\psi; \Sigma^+\rangle = |\psi; \Sigma^+\rangle \\ \hat{\mathcal{T}}|\psi; \emptyset\rangle = 0 \\ \hat{\mathcal{T}}|\psi; \Sigma^-\rangle = -|\psi; \Sigma^-\rangle \end{array} . \quad (1.10.19)$$

As a guess for how we might describe the new chirological states with the ontological basis, we will introduce notation such that

$$\begin{array}{ll} |\psi; \Omega\rangle = |\psi(x); \hat{\Phi}\rangle & |\psi; \Sigma^+\rangle = |\psi(\chi); \hat{\Phi}\rangle \\ |\psi; \mathcal{H}\rangle = |\psi(x); \hat{\pi}\rangle & |\psi; \emptyset\rangle = |\psi(\chi); \hat{i}\rangle \\ |\psi; \mathcal{A}\rangle = |\psi(x); \hat{2}\rangle & |\psi; \Sigma^-\rangle = |\psi(\chi); \hat{2}\rangle \end{array} . \quad (1.10.20)$$

This notation is made clearer when the $\psi(\chi)$ wavefunction is renamed with the letter ξ , i.e.:

$$|\xi; \Sigma^-\rangle = |\xi(\chi); \hat{2}\rangle , \quad \text{or} \quad |\xi; \Sigma^-\rangle = |\xi; \hat{2}\rangle . \quad (1.10.21)$$

We will use the ξ notation in following sections, but presently we will continue with the $|x^0\rangle$ and $|\chi^4\rangle$ notations.

The structure of quantum theory is such that there should exist a transformation matrix for expressing an arbitrary cosmology state in the chronological or chirological time arrow eigenbasis. If $\widehat{\text{MCM}}$ is the completeness relation, the $|t_\star\rangle = |x^0\rangle$ state is written in the chirological basis as

$$|x^0\rangle = \widehat{\text{MCM}}|x^0\rangle = \sum_k |\chi_k^4\rangle \langle \chi_k^4 | x^0 \rangle = \sum_k c_k |\chi_k^4\rangle , \quad (1.10.22)$$

where $k \in \{+, \emptyset, -\}$. Letting $\widehat{\text{MCM}}$ be the completeness relation for chronological

states and taking $k \in \{+, \star, -\}$, we obtain

$$|\chi_{\emptyset}^4\rangle = \widehat{\text{MCM}}|\chi_{\emptyset}^4\rangle = \sum_k |t_k\rangle \langle t_k | \chi_{\emptyset}^4\rangle = \sum_k c_k |t_k\rangle \quad , \quad (1.10.23)$$

By setting $c_{\star} = c_{\emptyset} = 0$, we will obtain equations roughly in the form of (1.10.13):

$$|x^0\rangle = |\chi_+^4\rangle + |\chi_-^4\rangle \quad , \quad \text{and} \quad |\chi_{\emptyset}^4\rangle = |t_+\rangle + |t_-\rangle \quad . \quad (1.10.24)$$

However, this does not necessarily reflect the argument that an observer's inability to distinguish t_{\pm} should lead to the superposition

$$|t_{\star}\rangle = |t_+\rangle + |t_-\rangle \quad . \quad (1.10.25)$$

As a guiding principle, one notes that the orthogonal eigenvectors of an operator can never be expressed as linear combinations of the other eigenvectors. This is contrary to what is presumed for the $|x^0\rangle = |x_+^0\rangle + |x_-^0\rangle$ relationship if $|x^0\rangle$ is an eigenvector of \hat{T} with eigenvalue 0. The similar $|x^0\rangle = |\chi_+^4\rangle + |\chi_-^4\rangle$ has no such problem, so $|x^0\rangle \neq |\text{bounce}\rangle$ is implied. We will revisit these issues in Section 12 when presenting time arrow spinor states that only have ± 1 eigenvalues. Presently, more thinking is required to understand what reason we might have to set $c_{\star} = c_{\emptyset} = 0$ in the expansions of $|t_{\star}\rangle$ and $|\text{bounce}\rangle$, or if we should work in a basis that does not have a zero eigenvalue.¹ For example, it was decided in [40] that we should write $\widehat{\text{MCM}}|\text{bounce}\rangle = |t_+\rangle + |t_-\rangle$, but not

$$\widehat{\text{MCM}}|\text{bounce}\rangle = |t_+\rangle + |t_-\rangle + |t_{\star}\rangle \quad , \quad (1.10.26)$$

because $|t_{\star}\rangle$ and $|\text{bounce}\rangle$ were identified. Subsequently, we have disassociated them as \mathcal{H} and \emptyset , so we must consider (1.10.26) as a valid case of (1.10.23) deserving further inquiry with $c_{\star} \neq 0$.

Now that we have introduced **time arrow eigenstates**, we have set the stage for a new approach to quantum gravity. Then we will return to MCM cosmology states in Section 12.

1.10.3 A New Approach to Quantum Gravity

The completeness relations for time arrow states allow us to more tidily phrase general relativity as a relationship between the stress-energy tensor in the present and a sum of

¹One might attempt to implement non-conservation of information in the information-conserving framework of quantum theory via transformations between 2D and 3D time arrow eigenstate bases for MCM quantum cosmology states.

contributions from the past and future. In the method of Section 1.10.1, we supposed that there should be two different ways for \hat{M}^3 to act on ψ , but this was not well motivated. To proceed with a better derivation of Einstein's equation, we will operate with \hat{M}^3 on a state written in the chronological and chirological eigenbases. Using the ξ notation as in (1.10.21), completeness yields

$$|\psi; \hat{\pi}\rangle = \sum_k |\xi; \hat{e}_k\rangle \langle \xi; \hat{e}_k | \psi; \hat{\pi}\rangle = c_+ |\xi; \hat{\Phi}\rangle + c_\emptyset |\xi; \hat{i}\rangle + c_- |\xi; \hat{2}\rangle \quad . \quad (1.10.27)$$

Acting with \hat{M}^3 on both sides yields

$$\hat{M}^3 |\psi; \hat{\pi}\rangle = \hat{M}^3 \left(c_+ |\xi; \hat{\Phi}\rangle + c_\emptyset |\xi; \hat{i}\rangle + c_- |\xi; \hat{2}\rangle \right) \quad . \quad (1.10.28)$$

Now we may say that \hat{M}^3 has different representations when it acts on states written in the different time arrow eigenbases. For example, the \hat{S}_z spin operator is only $\hbar/2$ times the σ_z Pauli matrix when it operates on states written in the S_z eigenbasis. It takes a different form when it operates on states written in the S_x or S_y eigenbases. One of the major deficiencies in the MCM has been the lack of a good reason for why \hat{M}^3 might act on a state in two different ways, as in (1.10.2), and now we have one: \hat{M}^3 acts on chronological states differently than chirological ones. The extent to which such a mechanism was a missing puzzle piece in the MCM cannot be overstated. (1.10.28) is probably the most significant new result reported in this book.

To proceed from (1.10.28) differently than the previous derivation starting at (1.10.2), we will work in the picture where states in different branes are linearly independent:

$$\langle \psi; \hat{e}_\mu^m | \psi; \hat{e}_\nu^n \rangle = \delta_{mn} \delta_{\mu\nu} \| \hat{e}_\mu^m \| \| \hat{e}_\nu^n \| \quad .^1 \quad (1.10.29)$$

Once again assuming that \hat{M}^3 operates on the chronological state as the third chronological time derivative, we have

$$8i\pi^3 \nu^3 |\psi; \hat{\pi}\rangle = \hat{M}^3 \left(c_+ |\xi; \hat{\Phi}\rangle + c_\emptyset |\xi; \hat{i}\rangle + c_- |\xi; \hat{2}\rangle \right) \quad . \quad (1.10.30)$$

Assuming $c_\emptyset = 0$, this reduces to Einstein's equation via

$$\begin{aligned} i\pi^2 \nu^3 |\psi; \hat{\pi}\rangle &\rightarrow T_{\mu\nu} \\ c_+ \hat{M}^3 |\xi; \hat{\Phi}\rangle &\rightarrow G_{\mu\nu} \\ c_- \hat{M}^3 |\xi; \hat{2}\rangle &\rightarrow g_{\mu\nu} \Lambda \quad , \end{aligned} \quad (1.10.31)$$

¹Compare to (1.10.3).

or similar. The cases for $c_\emptyset \neq 0$ would be accommodated by the parts of $G_{\mu\nu} = R_{\mu\nu} - \frac{R}{2}g_{\mu\nu}$. Since we have taken the states in different branes to be linearly independent, we might write the $c_\emptyset = 0$ case as

$$\begin{aligned} i\pi^2\nu^3|\psi; \hat{\pi}\rangle &\rightarrow T_{\mu\nu} \\ c_+\hat{M}^3|\xi; \hat{\Phi}\rangle &\rightarrow R_{\mu\nu} \\ c_-\hat{M}^3|\xi; \hat{2}\rangle &\rightarrow \left(\Lambda - \frac{R}{2}\right)g_{\mu\nu} \quad . \end{aligned} \tag{1.10.32}$$

The previous definition for the new variables

$$\begin{aligned} i\Phi\nu^3|\psi; \hat{\pi}\rangle &\rightarrow T_{\mu\nu} \\ 2|\psi; \hat{\Phi}\rangle &\rightarrow G_{\mu\nu} \\ |\psi; \hat{2}\rangle &\rightarrow g_{\mu\nu}\Lambda \quad . \end{aligned} \tag{1.10.33}$$

in Section 1.10.1 left an open question about how the same ψ could be mapped to three different tensors when the \hat{e}_μ do not analytically represent much more than a change of scale. In (1.10.31) and (1.10.32), this problem may be avoided if chirological states are not eigenstates of \hat{M}^3 . Work is needed to develop the $\psi(x)$ and $\xi(\chi)$ analytical representations of the time arrow states and to determine the transformation equations for obtaining the gravitational theory. Finding the exact correspondence between MCM states and GR tensors is the principal outstanding work unit for MCM quantum gravity.

Overall, the language of the respective time basis states answers a question which was left open in previous descriptions of MCM quantum gravity [1, 3, 72, 95–97]. Now \hat{M}^3 can operate on the same state in two different ways if the state is represented in two different eigenbases. Finally, the identification of \hat{M}^3 as a third time derivative in one representation remains in good agreement with our other intention to generate the $(\Phi\pi)^3$ term needed for α_{MCM} .

1.10.4 Comparison to Higgs' Seminal Result

To demonstrate that the MCM mechanism for quantum gravity represents a standard method in physics, we will compare it to the method used by Higgs in his 1964 paper regarding what is now called the Higgs(–Englert–Brout–Guralnik–Hagen–Kibble) mechanism. Higgs wrote the following [12].

“[Consider the case in which two] scalar fields φ_1, φ_2 and a real vector

field A_μ interact through the Lagrangian density

$$L = -\frac{1}{2}(\nabla\varphi_1)^2 - \frac{1}{2}(\nabla\varphi_2)^2 - V(\varphi_1^2 + \varphi_2^2) - \frac{1}{4}F_{\mu\nu}F^{\mu\nu} \quad , \quad (1.10.34)$$

where

$$\begin{aligned} \nabla_\mu\varphi_1 &= \partial_\mu\varphi_1 - eA_\mu\varphi_2 \\ \nabla_\mu\varphi_2 &= \partial_\mu\varphi_2 + eA_\mu\varphi_1 \\ F_{\mu\nu} &= \partial_\mu A_\nu - \partial_\nu A_\mu \quad , \end{aligned} \quad (1.10.35)$$

e is a dimensionless coupling constant, and the metric is taken as $-+++$. L is invariant under simultaneous gauge transformations of the first kind on $\varphi_1 \pm i\varphi_2$ and the second kind on A_μ . Let us suppose that $V'(\varphi_0^2) = 0, V''(\varphi_0^2) > 0$; then spontaneous breakdown of U(1) symmetry occurs. Consider the equations (derived from [(1.10.34)] by treating $\Delta\varphi_1, \Delta\varphi_2$, and A_μ as small quantities) governing the propagation of small oscillations about the ‘vacuum’ solutions $\varphi_1(x) = 0, \varphi_2(x) = \varphi_0$:

$$\begin{aligned} \partial^\mu \{ \partial_\mu(\Delta\varphi_1) - e\varphi_0 A_\mu \} &= 0 \quad , \\ \{ \partial^2 - 4\varphi_0^2 V''(\varphi_0^2) \} (\Delta\varphi_2) &= 0 \quad , \\ \partial_\nu F^{\mu\nu} &= e\varphi_0 \{ \partial^\mu(\Delta\varphi_1) - e\varphi_0 A_\mu \} \quad . \end{aligned} \quad (1.10.36)$$

Equation [(1.10.36b)] describes wave whose quanta have (bare) mass $2\varphi_0\{V''(\varphi_0^2)\}^{1/2}$; Eqs. [(1.10.36a)] and [(1.10.36c)] may be transformed, by the introduction of new variables

$$\begin{aligned} B_\mu &= A_\mu - (e\varphi_0)^{-1} \partial_\mu(\Delta\varphi_1) \quad , \\ G_{\mu\nu} &= \partial_\mu B_\nu - \partial_\nu B_\mu = F_{\mu\nu} \quad , \end{aligned} \quad (1.10.37)$$

into the form

$$\partial_\mu B^\mu = 0 \quad , \quad \partial_\nu G^{\mu\nu} + e^2 \varphi_0^2 B^\mu = 0 \quad . \quad (1.10.38)$$

Equation [(1.10.38)] describes vector waves whose quanta have (bare) mass $e\varphi_0$. In the absence of the gauge field coupling ($e=0$) the situation is quite different: Equations [(1.10.36a)] and [(1.10.36c)] describe zero-mass scalar and vector bosons, respectively. In passing, we note that the right-hand side of [(1.10.36c)] is just the linear approximation to the conserved current[.]”

In (1.10.35), Higgs assumes his scalar fields φ_1, φ_2 obey certain equations. Similarly, we have assumed that there exist two different, complete time arrow eigenbases satisfying

$$\hat{M}^3|\psi; \hat{\pi}\rangle = \partial_0^3|\psi; \hat{\pi}\rangle \quad , \quad \text{and} \quad |\psi; \hat{\pi}\rangle = c_+|\xi; \hat{\Phi}\rangle + c_\emptyset|\xi; \hat{i}\rangle + c_-|\xi; \hat{2}\rangle \quad . \quad (1.10.39)$$

Higgs imposes a broken U(1) symmetry by setting $V'(\varphi_0^2) = 0$ and $V'(\varphi_0^2) > 0$. We have set $c_\emptyset = 0$ to write

$$8i\pi^3\nu^3|\psi; \hat{\pi}^1\rangle = c_+\hat{M}^3|\xi; \hat{\Phi}\rangle + c_-\hat{M}^3|\xi; \hat{2}\rangle \quad . \quad (1.10.40)$$

Next, Higgs introduces variables B_μ and $G_{\mu\nu}$. Our next step was to introduce new variables as

$$\begin{aligned} i\pi^2\nu^3|\psi; \hat{\pi}\rangle &\rightarrow T_{\mu\nu} \\ c_+\hat{M}^3|\xi; \hat{\Phi}\rangle &\rightarrow G_{\mu\nu} \\ c_-\hat{M}^3|\xi; \hat{2}\rangle &\rightarrow g_{\mu\nu}\Lambda \quad . \end{aligned} \quad (1.10.41)$$

Written in his new variables, Higgs claims that (1.10.38) “describes vector waves whose quanta have (bare) mass $e\varphi_0$.” We have claimed that (1.10.40) written in terms of our new variables is Einstein’s equation, which is true.

The main deficiency of the MCM program relative to Higgs’ is that the new MCM variables are introduced by an unstated correspondence between rank-2 tensors whereas Higgs has given his new variables with definite tensorial equations. This deficiency requires remediation in future work.

1.10.5 An Alternative for \hat{M}^3

MCM quantum gravity is a relationship between \hat{M}^3 acting on a state’s representation in the chronological and chirological bases. Therefore, one might ask if $\hat{M}^3 : \mathcal{H} \rightarrow \Omega \rightarrow \mathcal{A} \rightarrow \mathcal{H}$ can be achieved by acting on chirological states rather than the $|\psi; \hat{\pi}\rangle$ chronological state that we have discussed. The representation of a chronological eigenstate in the chirological basis as

$$|\psi, t_0; \hat{\pi}^0\rangle \equiv |x^0\rangle = |\chi_+^4\rangle + |\chi_-^4\rangle \quad , \quad (1.10.42)$$

suggests that \hat{M}^3 acting on $|x^0\rangle$ would act on $|\chi_+^4\rangle$ and $|\chi_-^4\rangle$ simultaneously in the other representation. Recalling that the arrows of time point oppositely in Σ^\pm , \hat{M}^3 might evolve $|\chi_+^4\rangle$ and $|\chi_-^4\rangle$ to Ω and \mathcal{A} such that the evolved state $|\psi, t_1; \hat{\pi}^1\rangle$ is deter-

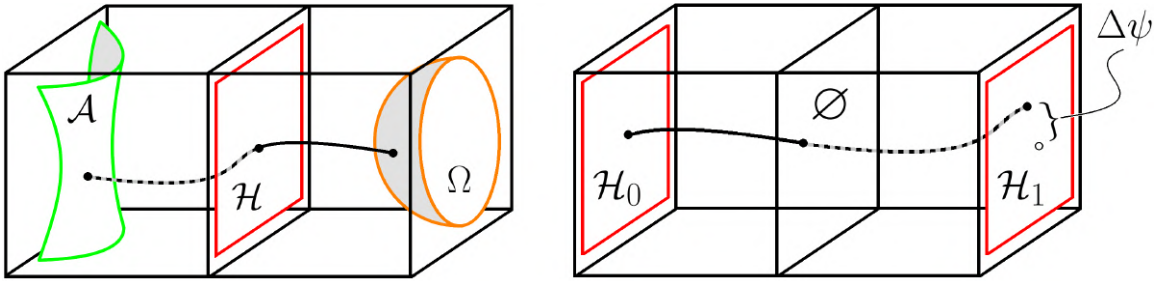

Figure 16: This figure illustrates a method in which one might avoid parameterizing a smooth curve through \emptyset . On the left, the solid and dashed lines show the trajectories of χ_+^4 and χ_-^4 eigenstates away from \mathcal{H} along their respective arrows of time. By concatenating the path through Σ^- to the end of the path through Σ^+ , we obtain an evolved $\psi + \Delta\psi$ state in \mathcal{H}_1 .

mined from the difference or ratio across \emptyset without computing a smooth trajectory through it. By fixing the path in Σ^+ and adjusting the path in Σ^- to fit a matching condition at \emptyset , the $|\psi, t_0; \hat{\pi}^0\rangle$ initial state would be adjusted to the $|\psi, t_1; \hat{\pi}^1\rangle$ final state in \mathcal{H}_1 , as in Figure 16.

This method would be a trick for computing the steps of \hat{M}^3 out of order so as to avoid computing a step of smooth evolution through \emptyset . One would attempt to correlate the $\Delta\psi$ obtained from this method with the $\Delta\psi$ obtained from the Schrödinger equation. The conjecture that this parallel method for \hat{M}^3 might exist is included here in large part because the possibility for reverse engineering a solution from the Schrödinger equation represents a definite work unit with an absolute calculation as its starting point.

1.10.6 The Planck Law

One of the most exciting features of the MCM mechanism for quantum gravity is the exotic ν^3 frequency dependence in the stress-energy tensor:

$$i\pi^2\nu^3|\psi; \hat{\pi}\rangle \rightarrow T_{\mu\nu} . \quad (1.10.43)$$

Physics' foremost setting for ν^3 is the Planck law

$$B(\nu, T) = \frac{2h\nu^3}{c^2} \frac{1}{e^{\frac{h\nu}{kT}} - 1} . \quad (1.10.44)$$

B is called the spectral radiance of blackbody radiation. The function $B(\nu, T)$ returns the energy carried by blackbody photons in each slice of constant wavelength at a

given temperature. Similarly, we have obtained Einstein's equation by associating the $\nu^3\psi$ term with the stress-energy tensor in \mathcal{H} which is the $\chi^4 = 0$ slice of the χ^4 spectrum (up to some nuance about $\chi_{\pm}^4 = 0$ not being defined.) This likeness of the stress-energy tensor and the spectral radiance is exciting because the ν^3 dependence is already known to describe energy per slice, and the Planck law is approximately the only place in physics where ν^3 appears. This congruence in the ν^3 dependency is interpreted as another strong hint that the MCM is producing results which deserve further study.

Written in terms of the wavelength, the Planck law is

$$B(\lambda, T) = -B(\nu, T) \frac{d\nu}{d\lambda} = \frac{2hc^2}{\lambda^5} \frac{1}{e^{\frac{hc}{\lambda kT}} - 1} . \quad (1.10.45)$$

This formula is true only for blackbody photons having dispersion relation $\omega(\lambda) = 2\pi c\lambda^{-1}$. The antiderivatives of (1.10.44) and (1.10.45) are proportional to ν^4 and λ^{-4} , and it is the antiderivatives which obey the $\lambda\nu = c$ on-shell dispersion relation for photons. Namely, it is only in the integrated radiance that we may make direct substitutions with $\omega(\lambda)$. For example, if we plug the photonic dispersion relation into (1.10.43), we get

$$i\pi^2\nu^3|\psi; \hat{\pi}\rangle = \frac{i\pi^2c^3}{\lambda^3}|\psi; \hat{\pi}\rangle , \quad (1.10.46)$$

which is not in the λ^{-5} form of (1.10.45). To preserve the relationship between the state corresponding to the stress-energy tensor and the Planck law, we must associate the integrated Planck law with the integrated wavefunction, as in the Dirac bra-ket. This is well reasoned because the wavefunction describing probability amplitude in some non-singular region of space would be associated with the Planck radiance in a non-singular band of the EM spectrum. Infinitesimal probability amplitude per position is matched with infinitesimal energy per wavelength. The expressions must be integrated for comparison to observables.

The Stefan–Boltzmann law says that the total emitted blackbody energy (per unit time) is equal to a constant times the fourth power of the temperature. Therefore, we would seek to associate the normalization of the MCM state with the temperature. χ^4 describes the relative scale of the normalization of states among different branes, so we may seek to associate χ^4 with the thermodynamic temperature T in $B(\nu, T)$ suggesting $(\nu, T) \rightarrow (x^0, \chi^4)$. With this identification of variables, it follows that the stress-energy tensor in question is the one at a definite chronological time in the brane whose scale is set by χ^4 . In good agreement, the state $|\psi; \hat{\pi}\rangle$ which maps to $T_{\mu\nu}$ is implicitly $|\psi, t; \hat{\pi}\rangle$ at some definite time t . Furthermore, Wien's displacement law

predicts the peak of the spectral intensity function, and this should be associated with the expectation of some operator operating on the state associated with $T_{\mu\nu}$.

1.10.7 A Large Enough Number of Coincidences

If the proof is in the pudding, we have only presented an exceptional basket of ingredients for \hat{M}^3 and its use cases. If \hat{M}^3 should never pan out, other results regarding the Riemann hypothesis, classical electrogravity, and the fundamental problem of QFT will stand on their own. Experimental data will eventually confirm that the spectrum of MCM lattice vibrations is the true particle spectrum, or it will not. In the hope and belief that \hat{M}^3 will pan out, the purpose of this section is to review and summarize a large number of positive results following from \hat{M}^3 and leading to Einstein's equation. These results support the supposed existence of the new variables needed to obtain general relativity from a picture of quantum mechanics.

Firstly, it must be emphasized that the original discovery of Einstein's equation in the MCM was not goal-sought. When it was found, there was no intention to find it. It was not recognized until it had already been written. After discovering $2\pi + (\Phi\pi)^3 \approx 137$, the operator \hat{M}^3 was goal-sought toward $(\Phi\pi)^3$, but that was not the case for the dimensionless 8π in

$$8\pi T_{\mu\nu} = G_{\mu\nu} + g_{\mu\nu}\Lambda \quad . \quad (1.10.47)$$

Neither was it the intention to show that GR is a restatement of the $\widehat{\text{MCM}}|t_\star\rangle = |t_+\rangle + |t_-\rangle$ equation which had already been supposed as the MCM's philosophical kernel [31, 40]. When 8π first appeared in 2012 [3], the context had nothing to do with GR. Given a translation operator definition of \hat{M}^3 as in

$$\hat{M}^3|\psi; \hat{\pi}^0\rangle = 2\pi\Phi|\psi; \hat{\pi}^1\rangle \quad ,^1 \quad (1.10.48)$$

it was asked what would happen if \hat{M} was a time derivative. The result which followed was described in Section 1.10.1. New variables were introduced, and the result was Einstein's equation [3, 96].

With the serendipity of the development now emphasized, it is acknowledged that the number of hypothesized and/or supposed inputs required to construct the original mechanism [3, 96] was large enough to generate the superficial appearance that a sufficiently long string of suppositions can be used to output any desired result. However, the quantum gravity result, which is a new tool for synthesizing the objects of two disparate mathematical languages, was not desired. It fell out on its own from

¹A different constant than $2\pi\Phi$ was used in [3].

unrelated thinking. Ten years later, the result is now greatly improved, as in Section 1.10.3. We have reduced the number of unanswered questions left by the original derivation. Those questions included the following.

- Why should \hat{M}^3 act on ψ in two different ways?
- If \hat{M}^3 does act on ψ in two different ways, why should one of them be a third time derivative?
- Why should we invoke the given numerical values for the ontological basis at all when linearly independent bases are usually defined by orthogonality irrespective of magnitude?
- Even if the above are granted, what is the definite relationship between the $|\psi; \hat{e}_\mu\rangle$ states and the objects in Einstein's equation?

\hat{M}^3 should have a different representation when acting on the eigenstates of the chronological and chirological time arrow operators. This answers the first question about why the other questions are worth asking. The second question asks why \hat{M}^3 should take the form of the third time derivative needed to generate 8π and the ν^3 connection to Planck's law. This question remains open, but $\hat{M}^3 = \partial^3$ was already found to be useful for work predating the quantum gravity application. It was expected that a third derivative is needed for $\hat{\alpha}|\Psi_\alpha\rangle = \alpha_{\text{MCM}}^{-1}|\Psi_\alpha\rangle$. The third derivative was also contextualized by the MCM reference to the theory of advanced and retarded EM potentials in [30]. This context predated the GR application, i.e.: the Abraham-Lorentz force

$$\mathbf{F}_{\text{AL}} = m(\ddot{\mathbf{x}} - \tau\dddot{\mathbf{x}}) \quad , \quad (1.10.49)$$

for radiation damping (Section 16) brought in a third time derivative a year before Einstein's equation was obtained. Finally, when it was observed that Laithwaite had suggested the time derivative of acceleration—another third derivative—as a possible cause for the anti-gravity effects observed in spinning discs [98, 99], this writer was inspired to explore the ansatz for $\hat{M}^3 \propto \partial_t^3$, and Einstein's equation was derived forthwith [3].

Another unanswered question regards the number-theoretical assignments for the ontological basis. The best that can be said is that the $\{\hat{e}_{\mathcal{A}}, \hat{e}_{\mathcal{H}}, \hat{e}_{\Omega}\}$ set of basis vectors, like the proposal to use the ∂_t^3 operator, was already entertained independently for reasons unrelated to quantum gravity [30]. Only later were the ontological numbers found to output Einstein's equation [3].

When the dimensionless coefficient 8π familiar from $8\pi T_{\mu\nu} = G_{\mu\nu} + g_{\mu\nu}\Lambda$ appeared, it appeared on the heels of another famous dimensionless constant: α_{MCM} [3, 30]. Furthermore, the emergence of Einstein's equation as a formal restatement of the $|t_\star\rangle = |t_+\rangle + |t_-\rangle$ idea at the heart of the MCM was too much to be assigned as mere coincidence, in the eyes of this writer. Writing $\widehat{\text{MCM}}|\text{bounce}\rangle = |t_+\rangle + |t_-\rangle$ as Einstein's equation makes the tantalizing suggestion that the MCM requirement for global conservation of cosmological momentum is a restatement of the law already recorded in GR. 8π following so closely after α_{MCM} may be written off as mere coincidence by third parties, but, as the personal pet project of this writer, the coincidence hypothesis is rejected on the basis of too much coincidence. To argue that the reader should also see more coincidence than should be ignored, we will briefly resummarize the evolution of ideas.

The Theory of Negative Time A thermodynamic paradox arises in closed universe models when singularities at past and future timelike infinity are identical. The second law of thermodynamics requires that the state at future timelike infinity should have much higher entropy than the state at past timelike infinity. This is resolved by the introduction of two universes coevolving simultaneously with opposite arrows of time [31]. The total entropy of both universes is a constant when the entropic increase of one is offset by the decrease in the other. As the logarithm of the number of microstates, the entropy should not be affected by any scale factor. Later, it was determined that a universe with a reversed time arrow is also required to fix a problem of non-conserved momentum in big bang models [40]. Namely, a big bang should decay to a superposition of positive and negative time modes:

$$\widehat{\text{MCM}}|\text{bounce}\rangle = |t_+\rangle + |t_-\rangle . \quad (1.10.50)$$

A Context for Retrocausality Transport of an observer's inertial frame through the bounce requires that the present moment should also be resolved in positive and negative time modes. In other words, if an observer in the big bang sees a superposition of two opposite time arrow states converging on his position, then he should see that at any other time as well. Hence, we arrive at

$$\widehat{\text{MCM}}|t_\star\rangle = |t_+\rangle + |t_-\rangle . \quad (1.10.51)$$

Fixation on the bounce as a novel moment in [31] was supplanted by the present being taken as the novel moment of greatest interest [40]. This paved the way for the connection to quantum mechanical Hilbert spaces of states at the present time.

(1.10.51) suggests equal places for causality and retrocausality. The main venue for such mechanisms in physics is the theory of the advanced and retarded electromagnetic potentials. The third time derivative in this theory is almost unique in physics. The idea that the MCM might use such a derivative was first considered in the context of the Abraham–Lorentz law with no regard for α_{MCM} or gravitation. This use case for the third derivative predated the similar requirement derived from the analytical form of α_{MCM} [30].

The Ontological Basis A labeling basis

$$\hat{\pi} \equiv \hat{e}_{\mathcal{H}} \quad , \quad \hat{2} \equiv \hat{e}_{\mathcal{A}} \quad , \quad \hat{\Phi} \equiv \hat{e}_{\Omega} \quad , \quad \text{and} \quad \hat{i} \equiv \hat{e}_{\emptyset} \quad , \quad (1.10.52)$$

was introduced to associate the usual $|\psi\rangle$ analytical formalism with the $\{t_*, t_+, t_-, \text{bounce}\}$ language:

$$\begin{aligned} |\psi; \hat{\pi}\rangle &= \psi(x^i, x^0) \\ |\psi; \hat{2}\rangle &= \psi(x_-^i, x_-^0) \\ |\psi; \hat{\Phi}\rangle &= \psi(x_+^i, x_+^0) \\ |\psi; \hat{i}\rangle &= \psi(x_{\emptyset}^i, x_{\emptyset}^0) \quad . \end{aligned} \quad (1.10.53)$$

This form of the \hat{e}_{μ} basis was called *the ontological basis* in reference to an intention to explain certain natural quantities with unique number-theoretical assignments. Future work may explore an alternative convention for $\hat{\tau}$ with $\tau = 2\pi$.

The Fine Structure Constant It was determined that the numbers in the chosen basis can be used to construct the dimensionless quantum electrodynamic coupling constant to within about 0.4% [30]:

$$\alpha_{\text{MCM}}^{-1} = 2\pi + (\Phi\pi)^3 \quad . \quad (1.10.54)$$

While some will cite the notion that α_{QED} is known to an accuracy far exceeding the 0.4% discrepancy with α_{MCM} , we have demonstrated in Section 1.9.4 that such precision does not rule out α_{MCM} . The cubed term in α_{MCM} was noted for its consistency with a hypothetical ∂_t^3 operator invoked through the context for retrocausality.

Mechanical Precession of Spinning Discs An independent but contemporaneous inquiry into the physics of spinning discs quickly led to Laithwaite’s suggestion that the time derivative of acceleration might be used to explain the anomalous anti-gravity

effects observed in spinning discs [98, 99]. After already seeing this rare derivative twice, calculations were made to determine what might result if $\hat{M}^3 \propto \partial_t^3$.

Einstein's Equation Following the novel result regarding α_{MCM} , the *triplely supported* ∂^3 form for \hat{M}^3 yielded a second novel numerical result: the dimensionless constant 8π well known from Einstein's equation

$$8\pi T_{\mu\nu} = G_{\mu\nu} + g_{\mu\nu}\Lambda \quad . \quad (1.10.55)$$

The third derivative had already been under consideration, as had the number-theoretical basis $\{\hat{\pi}, \hat{i}, \hat{\Phi}\}$ by which this equation was derived in [3]. There was no intention beforehand to show anything related to GR. As this was the second famous dimensionless constant derived with ∂^3 and the ontological numbers, and because it appeared while examining unrelated theoretical processes, more significance was assigned to the result than would have been assigned to a similar result appearing in isolation. The appearance of one such number is easily written off as meaningless coincidence. Two physically significant, dimensionless numbers are written off less easily.

The Ontological Resolution of the Identity Following the initial derivation of Einstein's equation, a third famous dimensionless coupling constant appeared with the addition of $\hat{e}_\varnothing = \hat{2}$:¹

$$\hat{1} = \frac{1}{4\pi}\hat{\pi} - \frac{\varphi}{4}\hat{\Phi} + \frac{1}{8}\hat{2} - \frac{i}{4}\hat{i} \quad . \quad (1.10.56)$$

In certain natural units, 4π is the dimensionless constant attached to the Poisson equations for Newtonian gravity and classical electromagnetism:

$$\rho = \frac{1}{4\pi}\nabla^2\phi \quad , \quad \text{and} \quad J^\mu = \frac{1}{4\pi}\eta^{\mu\nu}\partial_\nu\partial_\lambda A^\lambda \quad . \quad (1.10.57)$$

It is hoped that the ontological resolution of the identity will have vast applications toward unifying disparate forces of physics. Here, ontology refers to the theory that the number-theoretical properties of $\{\hat{\pi}, \hat{i}, \hat{\Phi}, \hat{2}\}$ should pertain to fundamental quantities observed in nature.

¹Following the introduction of $\hat{2}$, the respective assignments of \hat{i} and $\hat{2}$ to the \mathcal{A} - and \varnothing -branes were swapped.

1.11 Elliptic Curves and the Total Evolution Operator

In this section, we will examine a few properties and iterations of the expected total evolution operator [3, 30]

$$\hat{\Upsilon} = \hat{\mathcal{U}} + \hat{M}^3 . \quad (1.11.1)$$

We will emphasize an equation for joint chronological and chirological evolutions such that

$$|\psi, t_0; \hat{\pi}^0\rangle \longrightarrow |\psi, t_1; \hat{\pi}^1\rangle . \quad (1.11.2)$$

Then we will show that the cumulative body of MCM material suggests elliptic curves as the solutions to the evolution equation for \hat{M}^3 and $\hat{\Upsilon}$. In the absence of a definite equation for $\hat{\Upsilon}$ or \hat{M}^3 , however, that which can be said about them is limited. Much of this section will discuss what does not work before we suggest in Section 1.11.5 that the missing equation is an elliptic curve, or like an elliptic curve.

1.11.1 The Original Proposal for $\hat{\Upsilon}$

The context for \hat{M}^3 in the previous sections has been motivated by the three steps of $\mathcal{H} \rightarrow \Omega \rightarrow \mathcal{A} \rightarrow \mathcal{H}$ inherent to the unit cell, and the original motivation for \hat{M}^3 (Appendix A) was that some operator should return the cubed term in α_{MCM}^{-1} . $\hat{\Upsilon}$ was formulated in [3, 30] to return α_{MCM}^{-1} as the sum of \hat{M}^3 with another operator appearing in its first power. The $\Phi\pi$ term was expected to be associated with some new mechanism since Φ does not usually appear in QM, and the only reasonable choice for the linear derivative returning 2π was ∂_x . This is the momentum operator divided by a constant, but that operator lacks the complexity required for a new role in physics. Namely, $\hat{\Upsilon}$ was envisioned as an evolution operator returning α^{-1} as the characteristic value of some ontological evolution in the way that the unitary evolution operator $\hat{\mathcal{U}}$ returns $e^{-iEt/\hbar}$ when \hat{H} does not depend on t . The value for α should be universal because the evolution generated by $\hat{\Upsilon}$ will reflect some universal structure underlying time evolution. The 2D spacetime box first proposed for that structure has been deprecated,¹ but the modern thinking remains the same: α should characterize the unit cell.

Rather than choosing the ∂_x derivative directly, we selected $\hat{\mathcal{U}}$. The idea was that $\hat{\mathcal{U}}$ is proportional to ∂_x as

$$\hat{\mathcal{U}}(t, t_0) = \exp\left\{\frac{-i\hat{H}(t - t_0)}{\hbar}\right\} , \quad \text{with} \quad \hat{H} = \frac{-\hbar^2}{2m}\partial_x^2 + \hat{V} , \quad (1.11.3)$$

¹Schrödinger's original derivation of his equation from the stationary action principle [81] has been deprecated even while the underlying equation remains the same. Presently, the invariant equation is $\alpha_{\text{MCM}}^{-1} = 2\pi + (\Phi\pi)^3$.

and \hat{M}^3 should be a complementary operator proportional to the time derivative. This was written as

$$\hat{U} \propto \partial_x \quad , \quad \text{and} \quad \hat{M} \propto \partial_t \quad . \quad (1.11.4)$$

Whatever formalism might have selected ∂_x from \hat{H} with a square root, as well as the likelihood that \hat{Y} would have returned $\exp(\alpha_{\text{MCM}}^{-1})$, was left to omitted details via the $:=$ relationship. (The relationships in (1.11.4) were originally stated with the $:=$ symbol meaning “is defined according to” rather than the present \propto symbol meaning “is proportional to.”)

The case for using \hat{U} was mainly to force an association of the \hat{Y} operator with time evolution, and to frame \hat{M}^3 as a new kind of time evolution operator. However, the reference to \hat{U} in early work rather than simply writing $\hat{Y} = \partial_x + \hat{M}^3$ may have clouded the intended meaning. Heavy reliance on the $:=$ formalism to omit less important, ancillary mathematical details also may have hindered what was intended to be a rapid communication [3, 30].

1.11.2 \hat{Y} Redefined with ∂_0 and ∂_4

Work subsequent to [3, 30] introduced the χ^4 variables which alter the possibilities for \hat{Y} . Namely, if \hat{U} is the chronological time evolution operator then \hat{M}^3 should complement it as the chirological time evolution operator:

$$\begin{array}{ccc} \hat{U} \propto \partial_x & \xrightarrow{\text{New } \chi^4 \text{ variables}} & \hat{U} : \partial_0 \\ \hat{M}^3 \propto \partial_t^3 & & \hat{M}^3 : \partial_4^3 \quad . \end{array} \quad (1.11.5)$$

It was pointed out in Section 1.9.3 that ∂_x can return 2π in a problem of one spatial dimension, but the more realistic ∇ operator in 3D will return a sum of three terms incompatible with α_{MCM} . The introduction of ∂_4 allows us to avoid this problem. The spatial derivative does not appear in the new relationships $\hat{U} : \partial_0$ and $\hat{M}^3 : \partial_4^3$. Removing ∂_i from consideration motivates the universality of the returned value α because we have eliminated non-universal contributions from arbitrary $V(x)$ potential energy landscapes. The constant width of the unit cell in the abstract coordinates for any chronological time step between measurements sketches a good reason for why the total evolution operator should return a constant value in arbitrary systems.

The meaning on the right in (1.11.5) is that ∂_0 acts on \hat{U} in Schrödinger’s equation as

$$i\hbar\partial_0\hat{U} = \hat{H}\hat{U} \quad , \quad (1.11.6)$$

and \hat{M}^3 is meant to complement that as, for example,

$$\hat{\Upsilon} = i\hbar\partial_0\hat{\mathcal{U}} + \partial_4^3\hat{M}^3 \quad . \quad (1.11.7)$$

A first guess for an equation for $\hat{\Upsilon}$ would be

$$\partial_4^3\hat{M}^3 + i\hbar\partial_0\hat{\mathcal{U}} = \hat{H}_{\text{MCM}}(\hat{\mathcal{U}} + \hat{M}^3) \quad . \quad (1.11.8)$$

In presenting this guess, we demonstrate what was meant when it was written in [3] that \hat{M}^3 should “complement” $\hat{\mathcal{U}}$. The reader is also reminded that Schrödinger’s equation comes “out of the mind of Schrödinger,” as Feynman puts it [100], and nowhere else. It has not been derived from first principles, and it is not expected that first principles analysis will conclude with a new total evolution equation for $\hat{\Upsilon}$. Rather, (1.11.8) is an example of a new equation for \hat{M}^3 which should reduce to Schrödinger’s equation in the limit vanishing χ^4 and vanishing derivatives with respect to χ^4 . The vanishing derivative removes \hat{M}^3 on the left and vanishing χ^4 should remove it on the right. Without those terms, (1.11.8) is the Schrödinger equation in \mathcal{H} .

1.11.3 The Schrödinger Equation for $\hat{\Upsilon}$

Considering $\hat{\Upsilon}$ as it was before χ^4 , Schrödinger’s equation for $\hat{\mathcal{U}} + \hat{M}^3$ is

$$i\hbar\partial_0(\hat{\mathcal{U}} + \hat{M}^3) = \hat{H}(\hat{\mathcal{U}} + \hat{M}^3) \quad . \quad (1.11.9)$$

If \hat{H} is a pre-MCM Hamiltonian, then (1.11.9) is separable as

$$i\hbar\partial_0\hat{\mathcal{U}} = \hat{H}\hat{\mathcal{U}} \quad , \quad \text{and} \quad i\hbar\partial_0\hat{M}^3 = \hat{H}\hat{M}^3 \quad . \quad (1.11.10)$$

The condition that \hat{H} is “pre-MCM” means that $i\hbar\partial_0\hat{\mathcal{U}} = \hat{H}\hat{\mathcal{U}}$ is valid. If \hat{M}^3 depends on x^0 , then it is equal to $\hat{\mathcal{U}}$. If it does not depend on x^0 , then $\partial_0\hat{M}^3 = 0$, and it follows that $\hat{M}^3 = 0$ or $\hat{H} = 0$. These results are not useful. Under the naive operation of \hat{M}^3 as a translation operator, we have

$$\begin{aligned} \hat{\Upsilon}|\psi, t_0; \hat{\pi}^0\rangle &= \hat{\mathcal{U}}|\psi, t_0; \hat{\pi}^0\rangle + \hat{M}^3|\psi, t_0; \hat{\pi}^0\rangle \\ &= |\psi, t_1, \hat{\pi}^0\rangle + 2\pi\Phi|\psi, t_0; \hat{\pi}^1\rangle \quad . \end{aligned} \quad (1.11.11)$$

The orthogonality of MCM plane waves is such that wavefunctions in $\hat{\pi}^k$ cannot interfere with those in $\hat{\pi}^j$ if $k \neq j$. They are linearly independent. If such states did interfere, then (1.11.11) could, in principle, yield one coherent probability amplitude

for a state at time t_1 on level $\hat{\pi}^1$. However, the orthogonality of wavefunctions on different levels of aleph is required for other applications, and we should not suppose that they might not be orthogonal. Using \hat{M}^3 as a translation operator, a coherent amplitude with the correct t and $\hat{\pi}^k$ specifiers is generated by

$$\hat{\mathcal{U}}(t, 0)\hat{M}^3|\psi, 0; \hat{\pi}^0\rangle = 2\pi\Phi|\psi, t; \hat{\pi}^1\rangle . \quad (1.11.12)$$

Schrödinger's equation for $\hat{\mathcal{U}}\hat{M}^3$ is

$$\begin{aligned} i\hbar\partial_0|\psi, t; \hat{\pi}^1\rangle &= \hat{H}|\psi, t; \hat{\pi}^1\rangle \\ \frac{i\hbar}{2\pi\Phi}\partial_0\hat{\mathcal{U}}\hat{M}^3|\psi, 0; \hat{\pi}^0\rangle &= \hat{H}\hat{\mathcal{U}}\hat{M}^3|\psi, 0; \hat{\pi}^0\rangle \\ \frac{i\hbar}{2\pi\Phi}\partial_0(e^{-i\hat{H}t/\hbar}\hat{M}^3) &= \hat{H}e^{-i\hat{H}t/\hbar}\hat{M}^3 . \end{aligned} \quad (1.11.13)$$

If \hat{M}^3 does not depend on t , then

$$\hat{M}^3 = \exp\left\{\frac{-i\hat{H}(2\pi\Phi - 1)t}{\hbar}\right\} . \quad (1.11.14)$$

This \hat{M}^3 combines with $\hat{\mathcal{U}}$ as

$$\hat{\mathcal{U}}\hat{M}^3 = \exp\left\{\frac{-2\pi i\Phi\hat{H}t}{\hbar}\right\} . \quad (1.11.15)$$

We have added no physics with this equation. If not for the $2\pi\Phi$ scale factor, we would have found $\hat{M}^3 = \mathbb{1}$. \hat{M}^3 is still executing some form of equal-time parallel transport, albeit complemented with the $\hat{\mathcal{U}}$ operator.

Since the \hat{x} and \hat{p} operators don't commute, (1.11.15) begs that we ask about the commutation relations of $\hat{\mathcal{U}}$ and \hat{M}^3 . If $[\hat{\mathcal{U}}, \hat{M}^3] = 0$ as was assumed in (1.11.13), the chronological time step can be implemented anywhere during the transit of the unit cell. There would be no difference between landing on Ω or \mathcal{A} at t_0 or t_1 . This is not the desired behavior because it mitigates the dynamical uniqueness which the intermediate steps at Ω and \mathcal{A} were introduced to generate. Clearly, more physics is required. To the extent that the product $\hat{\mathcal{U}}\hat{M}^3$ seems better suited than $\hat{\mathcal{U}} + \hat{M}^3$ towards total evolutions in the form $|\psi, t_0, \hat{\pi}^0\rangle \rightarrow |\psi, t_1, \hat{\pi}^1\rangle$, we might consider $\hat{\Upsilon}$ such that

$$e^{-i\hat{\Upsilon}} = e^{-i\hat{H}t/\hbar}e^{-i\hat{M}^3} . \quad (1.11.16)$$

In this way of writing $\hat{\Upsilon}$, \hat{M}^3 complements $\hat{\mathcal{U}}$'s generator \hat{H} rather than $\hat{\mathcal{U}}$ itself. \hat{M}^3

becomes a new energy term of the sort discussed in Section 1.7.4.

1.11.4 Total Evolution by $\hat{\Upsilon}$

Toward an evolution equation, the $i\partial_0$ part of

$$\hat{\alpha} = i(\partial_0 - \partial_4^3) \quad ,^1 \quad (1.11.17)$$

is already in Schrödinger's equation, so

$$\hat{\alpha}|\psi\rangle = i(\partial_0 - \partial_4^3)|\psi_\alpha\rangle = \hat{H}_{\text{MCM}}|\psi_\alpha\rangle \quad , \quad (1.11.18)$$

is a good lead toward an equation for \hat{M}^3 . It contains a third derivative, and, given an appropriate \hat{H}_{MCM} , it almost reduces to Schrödinger's equation in the limit of vanishing χ^4 and ∂_4 derivatives. The only disagreement in that limit is the missing factor of \hbar . On that count, the units of (1.11.17) were not right to begin with. ∂_0 has units of inverse time, but ∂_4^3 probably does have those units. Indeed, the equation

$$i(\partial_0 - \partial_4^3)|\psi_\alpha\rangle = \left[2\pi + (\Phi\pi)^3\right] |\Psi_\alpha\rangle \quad , \quad (1.11.19)$$

does not return a manifestly dimensionless α_{MCM}^{-1} . Likewise, the operator on the left side of (1.11.18) is supposed to be dimensionless, but the returned value on the right is an energy. Given these problems with physical units, and given that the values 2π and $\Phi\pi$ must be fixed in Ψ_α when the wavenumber and frequency are usually allowed to vary in physical states, we might write an equation totally in the abstract coordinates as

$$i\left[\frac{\partial}{\partial\chi_0} - \frac{\partial^3}{\partial\chi_4^3}\right]|\Psi'_\alpha\rangle = -\frac{1}{2}\left[\frac{\partial^2}{\partial\chi_1^2} + \frac{\partial^2}{\partial\chi_2^2} + \frac{\partial^2}{\partial\chi_3^2}\right]|\Psi'_\alpha\rangle \quad . \quad (1.11.20)$$

This equation in which we have lowered the tensor indices for convenience sets \hat{H}_{MCM} as the chirological free particle Hamiltonian with $\hbar=m=1$, and we have replaced Ψ_α with

$$\Psi'_\alpha(\chi^0, \chi^i, \chi^4) = \exp\left\{-i(2\pi\chi^0 + \Phi\pi\chi^4 - k_i\chi^i)\right\} \quad . \quad (1.11.21)$$

We have not previously referred to the χ^0 and χ^i abstract coordinates. However, the question about the universality of the returned value for α is well wrapped up when we suppose a new equation which only involves derivatives with respect to the abstract coordinates.

¹This operator first appeared as (1.9.6).

1.11.5 Elliptic Curves

Elliptic curves are third order functions of two variables. Those in Figure 17 are of the form

$$y^2 = x^3 + ax + b \quad . \quad (1.11.22)$$

The two lower figures show the behavior of the Riemann ζ function near the $z = \infty$ north pole of the Riemann sphere [47,49]. Given a statement of \hat{Y} in which we obtain α_{MCM} by modifying the time part of Schrödinger's equation as

$$-i(\partial_4^3 - \partial_0)\psi = \hat{H}\psi \quad , \quad (1.11.23)$$

the remarkable likeness in Figure 17 is *quite remarkable*. The affine parameter along a smooth curve through Σ^\pm connecting two \mathcal{H} -branes must increase monotonically between \mathcal{H}_0 and \mathcal{H}_1 , as must the chronological time. Therefore, we are invited to parameterize χ^4 in terms of x^0 . Choosing $\chi^4 = \tau x^0$ allows us to rewrite (1.11.23) as

$$-i(\tau^3 \partial_0^3 - \partial_0)\psi = \left(\frac{-\hbar^2}{2m} \partial_x^2 + \hat{V} \right) \psi \quad . \quad (1.11.24)$$

By introducing new variables

$$x = i\tau \partial_0 \quad , \quad a = \tau^{-1} \quad , \quad y = \frac{i\hbar}{\sqrt{2m}} \partial_x \quad , \quad \text{and} \quad b = -\hat{V} \quad , \quad (1.11.25)$$

we obtain

$$(x^3 + ax + b)\psi = (y^2)\psi \quad . \quad (1.11.26)$$

This equation must be compared to (1.11.22). The ansatz equation (1.11.23) whose left side contains the $\hat{a} \sim \hat{Y}$ operator used to return α_{MCM}^{-1} is almost an identical elliptic curve. It is a differential equation whose characteristic curves or auxiliary equations are likely to be elliptic curves in the form of (1.11.22). The likeness of the two equations mirrors that between the classical dispersion relation and Schrödinger's equation:

$$\omega - \frac{k^2}{2m} = 0 \quad , \quad \text{and} \quad \left(i\hbar \partial_t + \frac{\hbar^2}{2m} \nabla^2 \right) \psi = 0 \quad , \quad (1.11.27)$$

under the change of variables

$$\omega \rightarrow i\hbar \partial_t \quad , \quad \text{and} \quad k \rightarrow i\hbar \nabla \quad . \quad (1.11.28)$$

Fundamental physical equations are usually simple representations of classes of

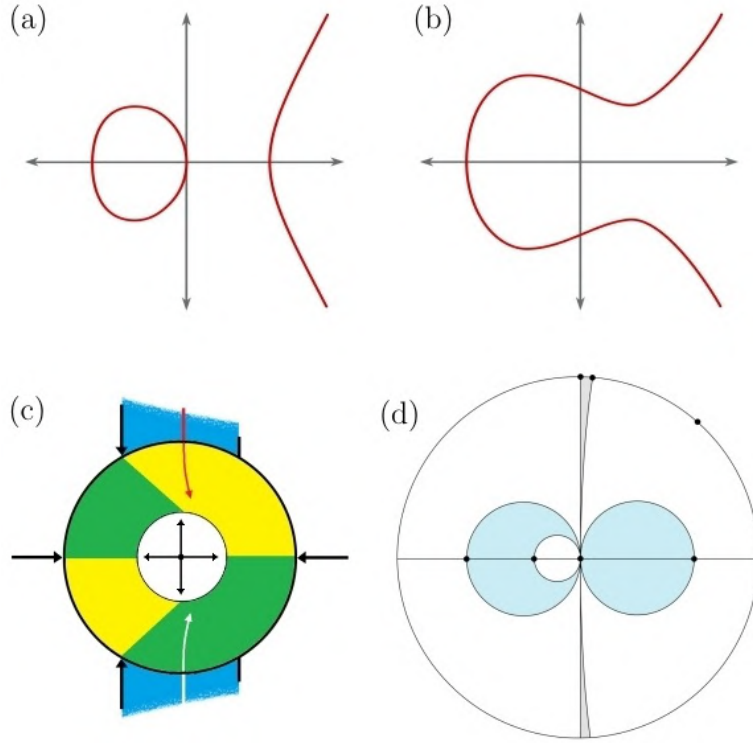

Figure 17: Above are two elliptic curves. Below are two figures showing the behavior of the Riemann ζ function around the north pole of the Riemann sphere. (a) The curve $y^2 = x^3 - x$. (b) The curve $y^2 = x^3 - x + 1$. (c) This figure is taken from [49] wherein the negation of the Riemann hypothesis was laid out in principle. (d) This figure is taken from [47], one of a few papers in which independent, formal negations of the Riemann hypothesis are given. The left-right asymmetry of (a) and (b) is qualitatively very similar to that in (c) and (d).

equations, so it is likely that the equation for \hat{M}^3 will be a well-known equation in elliptic curve analysis. Complicating factors on the path to finding the *exact* equation include the singularity $\widehat{\infty}$ appearing in \emptyset . The elliptic curves in Figure 17 are depicted near the origin, but the MCM curves are depicted near the opposite pole of the Riemann sphere at $z = \infty \notin \mathbb{C}$ (or $z = \widehat{\infty} \notin \mathbb{C}$.) This is likely to induce new complexity into the problem which may exceed the usual study of elliptic curves. Namely, the parameterization which allows us to replace ∂_4 with ∂_0 must go through a singularity at \emptyset . However, if we cast the equation with ∂^4 and ∂_4^3 , meaning that we parameterize x^0 in terms of χ^4 rather than vice versa, we might avoid the physical

singularity by remaining in the abstract coordinates.¹ In that case, the reversal of time arrows and the multiple dislocated origins for the piecewise χ_{\pm}^4 and χ_{\emptyset}^4 elements of what is only *called* χ^4 may complicate an assumption that χ^4 and x^0 monotonically increase in tandem between two \mathcal{H} -branes. This assumption is required for the affine parameterization of one as a linear expression of the other.

To emphasize that which is most intriguing in Figure 17, and to work toward dispelling any suggestion that the similar quality in the figure is meaningless in the way that certain qualia pertaining to \hat{M}^3 are said to be meaningless, consider Wiles' statement regarding the Birch and Swinnerton-Dyer conjecture [101].

“Mathematicians have always been fascinated by the problem of describing all solutions in whole numbers x, y, z to algebraic equations like

$$x^2 + y^2 = z^2 \quad . \quad (1.11.29)$$

Euclid gave the complete solution for that equation, but for more complicated equations this becomes extremely difficult. Indeed, in 1970 Yu. V. Matiyasevich showed that Hilbert's tenth problem is unsolvable, i.e., there is no general method for determining when such equations have a solution in whole numbers. But in special cases one can hope to say something. When the solutions are the points of an abelian variety, the Birch and Swinnerton-Dyer conjecture asserts that the size of the group of rational points is related to the behavior of an associated zeta function $\zeta(s)$ near the point $s = 1$. In particular this amazing conjecture asserts that if $\zeta(1)$ is equal to 0, then there are an infinite number of rational points (solutions), and conversely, if $\zeta(1)$ is not equal to 0, then there is only a finite number of such points.”

Considering that that Birch and Swinnerton-Dyer conjecture regards an object $L(C, z)$ where C is an elliptic curve, it is known that there exists at least one famous problem of interest relating elliptic curves to ζ functions. Therefore, a condition of total and/or profound irrelevance that detractors might cite for the correspondence in Figure 17 is not the true condition. We have sufficient reason to suppose a connection between the Riemann ζ function and elliptic curves, and a further connection to \hat{M}^3 . As to what the true condition of Figure 17 might be, the formal statement of the Birch and Swinnerton-Dyer conjecture [101] exceeds this writer's training.

¹Recall that χ_{\pm}^4 is taken as the Ricci scalar defining the dS and AdS physical $g_{\mu\nu}^{\pm}$ metrics when $A_{\pm}^{\mu} = 0$. Thus, $\chi_{\pm}^4 \rightarrow \pm\infty$ at \emptyset does not necessarily require an abstract singularity at \emptyset . (In the abstract coordinates, the location of \emptyset at a non-arithmetic number is a sufficient topological obstruction between Σ^{\pm} .)

Regarding the difficulty of Birch and Swinnerton-Dyer and its relevance to elliptic curves, Johnson writes the following [102].

“There is no doubt that elliptic curves are amongst the most closely and widely studied objects in mathematics today. *The arithmetic complexity of these particular curves is absolutely astonishing* [*emphasis added*], so it isn’t surprising the Birch and Swinnerton-Dyer conjecture has been honored with a place amongst the Clay Mathematics Institute’s famous Millennium Prize Problems. Although some great unsolved problems carry the benefit of simplicity in statement, this conjecture is not one of them. There even seems to be an aura of ‘hardness’ over the problem that keeps many from discovering the true beauty of the conjecture. [...] The Birch and Swinnerton-Dyer conjecture today remains, of course, unsolved and most mathematicians agree that new ideas will need to be developed to tackle the great problem. A proof will take a great deal of work and mathematical power.”

The present problem regarding the elliptic curve application for \hat{M}^3 's equation requires a survey of some large volume of number theory. The work might far exceed the ordinary scope of a PhD problem.

Part II: Problems in Physics

The thesis problems in Part II are presented with less detail than the problem in Part I. These problems are mostly applications for the MCM and/or fractional distance analysis toward open problems in physics.

2 Period Doubling

This problem in mathematical physics is as described in the following excerpt from [97]. It concerns period doubling behavior in equations such as (2.1).

“The original idea for a second number line such as that which appears in [*the MCM*]*—chiros as opposed to the original number line: chronos—came about in a study of the period doubling cascades that arise in chaotic dynamics. For example, consider convective rolls in a finite, bounded volume of fluid heated from below. [This physical system is described by*

$$\ddot{x} + k\dot{x} - x + 4x^3 = A \cos(\omega t) \quad . \quad (2.1)$$

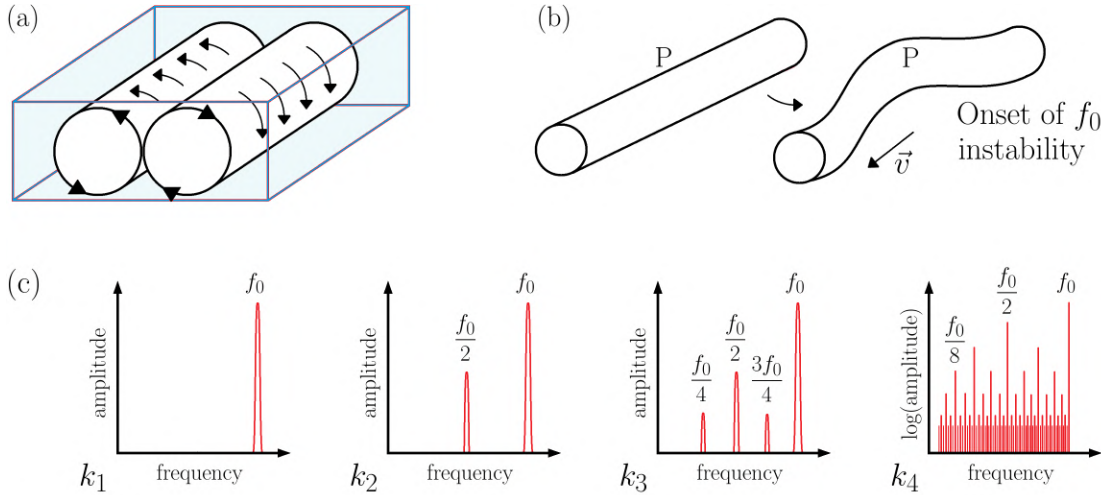

Figure 18: This figure is adapted from Cvitanović [103]. (a) Two stable, laminar convective rolls in a finite volume of fluid heated from below. (b) The development of an instability with frequency f_0 is shown. Waves will move along the axis of each cylinder with speed $|\vec{v}|$. In the laminar case, a temperature probe at P will show constant temperature. After the onset of first instability, the temperature at P will oscillate with frequency f_0 as the wave sweeps back and forth past the probe. (c) The period doubling cascade for four increasing values of k . As new modes of instability appear, the temperature at P will become increasingly erratic.

For low temperatures, heat convection in the fluid is laminar, as in Figure 18a.] When the temperature gradient in the cell reaches a first critical value [the laminar convective] rolls will become unstable. [Waves will] begin to move along the rolls' axial direction with some frequency f_0 [as in Figure 18b]. As the heat increases, more waves will appear with frequency $f_0/2$. [As] heating increases more[,] it will be possible to observe waves with frequency multiples of $f_0/4$, then $f_0/8$, etc., until period doubling exceeds the resolution of the experimental apparatus[,] and eventually the onset of turbulence is complete[, as in Figure 18c.]”

The dissipation parameter k in (2.1) is a mathematical representation of the heat flow through the fluid. As the heat at the bottom of the fluid volume continues to increase, a convective roll will acquire an instability moving axially with frequency f_0 (Figure 18b). It will become increasingly unstable in a regular way until full turbulence eventually sets in. The second instability will be a second axial wave with frequency $f_0/2$. In the regime of second instability, one understands that two waves

with different frequencies are superposed on the fluid cylinder. Recalling that period is inverse frequency, the period doubling cascade ends with the onset of turbulence associated with $f_0/2n$ as $n \rightarrow \infty$.

As k smoothly increases, the amplitude of existing instabilities increases. The nature of the present problem regards the transition from zero amplitude to non-zero amplitude as new modes of instability appear. Calling the amplitude associated with the n^{th} frequency mode A_n and using k_n to describe the value of k at which the n^{th} mode appears, we have

$$\lim_{k \rightarrow k_n^+} A_n(k) = 0 \quad . \quad (2.2)$$

One might think of adding k to Figure 18c in the direction perpendicular to the page so that each A_n appears as a long ridge terminating on a flat plane. As k is decreased back toward k_n after A_n has appeared, the amplitude of that instability must go to zero. An infinite number of $\partial_k^{(m)} A_n(k)$ derivatives must also go to zero as $k \rightarrow k_n^+$ because A_n does not exist for any $k < k_n$. In the estimation of this writer, this implies discontinuous behavior at k_n which cannot be derived by the smooth variation of k itself. For instance, the frequency peaks in Figure 18c should be described as Gaussians ϕ_n which have no zeros on the real line, so it is not clear where one might insert k into

$$\phi_n(f) = A_n \exp \left\{ \frac{(f - b)^2}{2c} \right\} \quad , \quad (2.3)$$

to affect

$$\lim_{k \rightarrow k_n^+} \phi_n = 0 \quad . \quad (2.4)$$

The equation from which A_n is derived, (2.1), is not piecewise defined, so we should not attempt to explain the discontinuous behavior in A_n with any piecewise solutions. Furthermore, there is no parameter in (2.1) other than k to which we might attribute the sudden onset of a non-zero A_n , unless there is another hidden parameter somewhere in the underbelly of mathematics.

By adding a hidden (abstract) parameter χ in a fourth orthogonal direction to the space of A , f , and k , we may trigger the onset of $A_n \neq 0$ where a curve parameterized in χ intersects the f - k plane. We would introduce conformal infinity functions $k_\chi = \tan(\gamma k + \delta)$ such that a zero of ϕ_n at $k_\chi = \pm\infty$ is moved to the intersection of k and χ at k_n . The main purpose of the second number line charted in χ will be to preserve information about the spacing of the k_n where conformal k_χ allows Gaussians to go to zero at the onset of new instability modes. In the conformal parameter, k cannot easily contain information about locations beyond infinity. The χ direction

is necessarily hidden from the ODE, but this mimics the condition in the unit cell where quantum states in \mathcal{H} know nothing about the bulk. Successive k_n should be like $\lim \chi_{\pm}^4 \rightarrow 0$ at successive \mathcal{H} -branes. The work of the present period doubling thesis would seek to embed an equation such as (2.1) in an analogue unit cell such that the discontinuous onset of new instability modes is triggered by something like an \mathcal{H} -brane where x^0 and χ^4 intersect, or k and χ in the present case. As we already have the Schrödinger equation to describe quantum evolution from t_1 to t_2 , but we have suggested another equation for \hat{M}^3 , this period doubling thesis might search for entirely new ways of solving differential equations.

Extensive and mysterious *universality in chaos* [103] can be taken to suggest a hidden parameter such as χ . It is not currently known why unrelated systems show remarkably similar behaviors in their chaotic limits. The ubiquity of constants such as Feigenbaum's numbers [104–106] in disparate chaotic systems is evocative of the universal numerical scheme in the ontological basis that we have used to append the unit cell to \mathcal{H} .

3 Field Line Breaking

Classical electromagnetism does not allow the formation of electromagnetic waves detached from their sources as propagating flux loops. This is unfortunate because the formation of such waves is thought to be a real physical process.

EM field lines are the level sets of the \mathbf{E} and \mathbf{B} fields which satisfy Maxwell's equations. These fields cannot have cusps in their level sets, but, for loops of flux to break off from their sources as propagating waves, a level set must acquire a cusp at some point: an X-point. The lack of any mechanism for such a process is a grievous deficiency in classical electromagnetism, and any resolution to this problem will have far-reaching consequences in almost all areas of physics. As it is, the tangent vector to a level set of the \mathbf{E} field points in the direction of \mathbf{E} , and it follows that \mathbf{E} would point in two different directions at an X-point.

Figure 19 shows field lines near an X-point: before and after. One is able to visualize the intermediate step at which the field lines must cross or reach a cusp, but that configuration of field lines is not a solution to Maxwell's equations. As in the period doubling cascade, here we must appeal to some new method for solving differential equations. The cusps can be smoothed over with quantum mechanics, but we would like to develop a method for field lines to break in classical field theory. Referring to Figure 19, note that field lines break and then reconnect to an exactly mirrored line. This is similar to what happens at \emptyset where χ_+^4 terminates on a

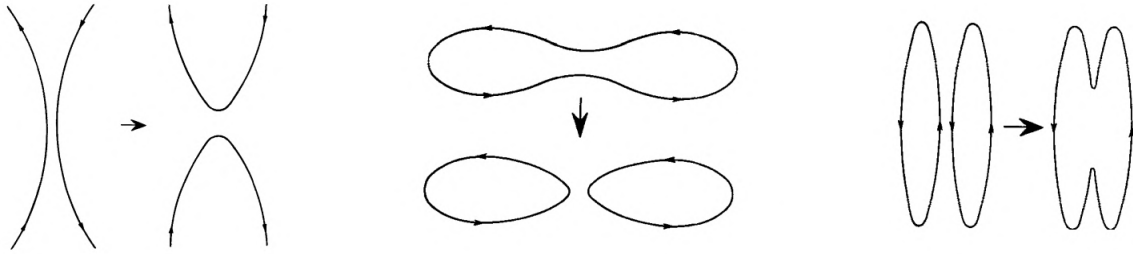

Figure 19: Figures due to McDonald [107] show EM field line configurations near X-points. The arrows show two cases of loops being formed and one case of two loops merging.

singularity and then continues along χ_-^4 on the higher level of aleph. The specular reflection suggested as a workaround for continuing χ^4 beyond \emptyset in Section 1.6.6 (and [72]) is suggested by the nearly-reflected field line configurations in Figure 19. So, the problem of field line breaking is similar to the problem of the forward connection of Σ^+ into Σ^- , and is not unlikely they are two sides of the same coin. Even the transition from topological AdS (the slices of Σ^-) to topological dS (the slices of Σ^+) exactly replicates the issue of field line breaking, as in Figure 20. The solutions of the AdS metric are hyperboloids of two sheets, and the solutions of the dS metric are hyperboloids of a single sheet. Between these spaces of uniform positive or negative curvature, the infinitely curved \emptyset -brane is like another X-point.¹ Even the pinching of the two classes of elliptic curve shown in Figure 17 (Section 1.11) is evocative of the same mysterious X-point.

Ideas for the utility of fractional distance analysis toward the X-point problem include the following. The arithmetic of numbers in the neighborhood of infinity may be related to field line breaking through loss of information about b in the $(\aleph_{\mathcal{X}} + b)/\widehat{\infty} = \mathcal{X}$ operation. If we were to incorporate levels of aleph into the solutions of differential equations, each time step being like an \mathcal{H} -brane or something similar, then two field lines passing through separate points $\aleph_{\mathcal{X}} + a$ and $\aleph_{\mathcal{X}} + b$ on one level of aleph would both pass through point \mathcal{X} on the higher level. Most generally, the identity $x/\widehat{\infty} = 0$ for any $x \in \mathbb{R}^0$ is a hard constraint on field solutions in the neighborhood of the origin, but this constraint is relaxed in the neighborhood of infinity where new behaviors may be possible. Indeed, new behaviors are implied by the new arithmetic operations [2]. Furthermore, the strength of the \mathbf{E} field where field lines cross is infinite, and $\widehat{\infty}$ is a new tool for dealing with infinite quantities. Similarly, $\mathbf{B} = 0$ at X-

¹Given a hyperboloid $x^2 + y^2 - z^2 = \ell^2$, we have a circle of radius ℓ in the $z=0$ plane. Decreasing the hyperboloid parameter ℓ reduces the radius of the circle, so the infinitely curved $\ell^2 = 0$ case corresponds to the cusped intermediate conical case not pictured in Figure 20.

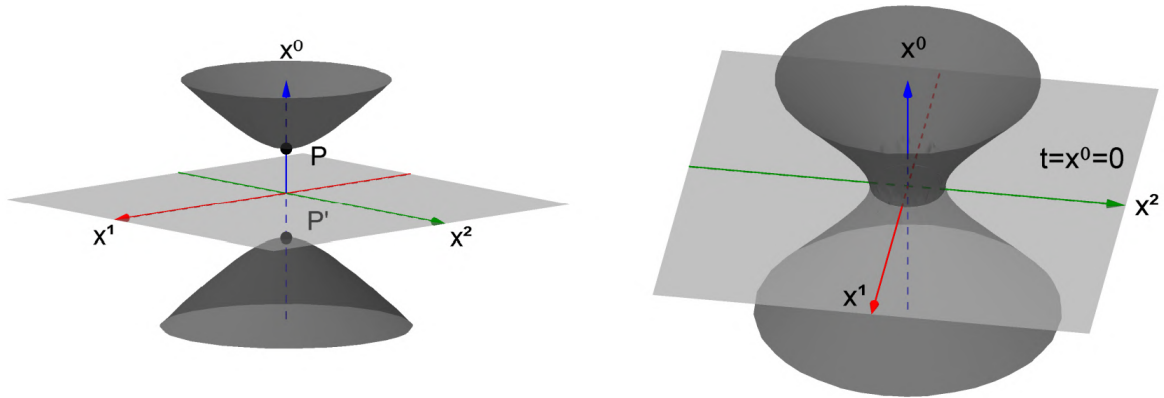

Figure 20: Figures due to Walker [108] show hyperboloids of one and two sheets. Anti-de Sitter space is associated with one of the two surfaces in a hyperboloid of two sheets (left) while de Sitter space is associated with a hyperboloid of one sheet. One may visualize an X-point associated with the flat geometry of \mathcal{H} which separates the slices of Σ^- from the slices of Σ^+ .

points, so we may study duality between $\hat{\infty}$ and $\widehat{\infty}$ for applications toward descriptions of the combined EM field.¹ Another idea is to use the big part of $\aleph_{\mathcal{X}} + b$ as the usual position variable such that the little part functions as an effective infinitesimal. Such quasi-infinitesimals may be useful for describing physics near X-points.

4 Curvature in the Neighborhood of Infinity

This problem regards the $\Omega \rightarrow \mathcal{A}$ step of \hat{M}^3 as well as the identity and function of the \emptyset -brane. If \emptyset is a topological singularity, we must determine what separates it from the regions of non-singular geometric curvature. To wit, fractional distance analysis [2] has provided the non-arithmetic numbers (Section 1.6.6) such that we may place \emptyset at $\mathcal{F}_{\mathcal{X}} \in \mathbb{F}$, but that program has not uniquely determined whether a single number separates successive $\mathbb{R}^{\mathcal{X}}$, or if there exist intervals between them. Figure 21 shows these possibilities. The set of all $x \in \mathbb{F}$ might be totally disconnected, or the $\mathcal{F}_{\mathcal{X}}$ could be the midpoints of neighborhoods of non-arithmetics as the $\aleph_{\mathcal{X}}$ are the midpoints of the $\mathbb{R}^{\mathcal{X}}$ neighborhoods. Pertaining to the unit cell, we have not decided if a single point separates the Ω - and \mathcal{A} -branes, if there exists an interval between

¹Duality between $\hat{\infty}$ and $\widehat{\infty}$ was detailed most specifically in [2, 47]. Briefly, suppose there exists a Euclidean line segment AB covered by a chart $x \in [0, \infty)$ with 0 at A and ∞ at B . (AB is covered except for an endpoint.) For every $n \in \mathbb{N}$ in the neighborhood of the origin, the invariance of AB under permutations of the labels of its endpoints implies the existence of another number $\widehat{\infty} - n$ in the neighborhood of infinity. Duality between $\hat{\infty}$ and $\widehat{\infty}$ means there exists a $\widehat{\infty} - n$ for every $\hat{\infty} + n \in \mathbb{N}$. The neighborhood of infinity is populated by the completion of \mathbb{N} with the rationals and irrationals.

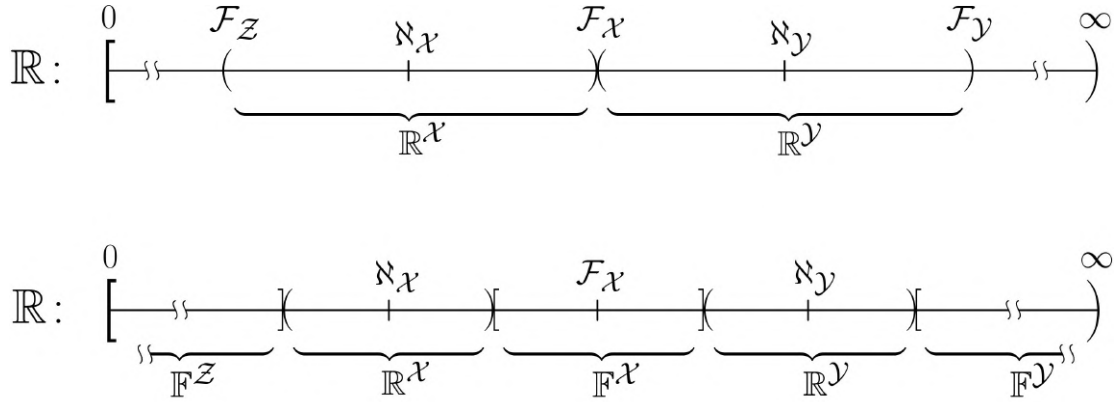

Figure 21: This figure demonstrates an open question in fractional distance analysis. Should the \mathbb{R}^X neighborhoods be separated by single non-arithmetic numbers $\mathcal{F}_X \in \mathbb{F}$ (above) or should they be separated by entire neighborhoods of non-arithmetics labeled \mathbb{F}^X (below)?

them, or if we might remove them from Σ^\pm to colocate them with \emptyset as their union: a single point separating Σ^\pm .

From \mathcal{A} to Ω , the physical curvature of the slices of Σ^\pm at constant χ_\pm^4 is given by a monotonic function $R_\pm(\chi_\pm^4)$.¹ R vanishes in the $\chi_\pm^4 \rightarrow 0$ limit associated with \mathcal{H} , and it diverges or has divergent-like behavior at \emptyset . Although there is a discontinuity at \mathcal{H} where the scale changes, the Ricci scalar is continuous across \mathcal{H} . The topology changes from two timelike and three spacelike dimensions in Σ^- to one and four in Σ^+ , but there is only a scale discontinuity in the geometry of the 4D slices.

At the $\Omega \rightarrow \mathcal{A}$ step of \hat{M}^3 , the case is much different. In addition to a discontinuity in the topology and an implicit scale discontinuity, there is a stark jump discontinuity from Ω 's non-vanishing positive geometric curvature to \mathcal{A} 's non-vanishing negative geometric curvature. While the discontinuity at \mathcal{H} can be associated with the act of observation or the start and stop points for \hat{M}^3 , the geometric and topological discontinuities at \emptyset can only be associated with the reversal of the time arrow and the increased level of aleph. It is not so hard to imagine the level of aleph changing the scale and metric signature, but the asymmetric geometric discontinuity between positive curvature in Ω and negative in \mathcal{A} is a harder problem. To solve such issues, it may be required to use the χ_\emptyset^4 coordinates to resolve a space between Ω and \mathcal{A} . On the other hand, if we increase the magnitude of the curvature in Ω and \mathcal{A} to

¹The subscript on R_\pm reflects a possible convention for increasing the curvature to $\pm\infty$ on \mathcal{A} and Ω . This would require two different conformal infinity functions, i.e.: $R_+(\chi_\pm^4) = \tan(\varphi\pi\chi_\pm^4/2)$ and $R_-(\chi_\pm^4) = \tan(\Phi\pi\chi_\pm^4/2)$. However, this is not the case if we assume $R(\chi_\pm^4) = \chi_\pm^4$ such that the Ricci scalar is Φ on Ω and $-\varphi$ on \mathcal{A} . Also, this function will be written as $R_\pm(\chi_\pm^4, A_\pm^\mu)$ most generally, but we ignore the second argument while $A_\pm^\mu = 0$.

infinity, then the jump discontinuity from positive curvature to negative curvature is greatly simplified. For example, the problem of joining a singularity of infinite positive curvature to one of infinite negative curvature seems far simpler than joining two maximally symmetric spaces with finite Ricci scalars $R_1 \neq R_2$. Something as simple as a minus sign used to reverse the arrow of time might be used to swap infinite positive curvature for infinite negative curvature. Indeed, the physics of a black hole/white hole pair is exactly what is needed to continue a trajectory along χ^4 past the singularity at \emptyset . A state would fall into the black hole along χ_+^4 and then be ejected in reverse time along χ_-^4 .

Proposals to separate Ω and \mathcal{A} by an interval, or to join them, point to the main problem in this section. Should Ω and \mathcal{A} be branes of infinite curvature? Should they act like an event horizon surrounding \emptyset ? If so, should an interval of χ_\emptyset^4 separate χ_\pm^4 ? Perhaps \mathcal{A} and Ω should mark the onset of curvature in the neighborhood of infinity? Curvature in the neighborhood of infinity presents a case for new physics in fractional distance analysis because such curvature would describe a physical singularity but not a mathematical one.

The Ricci scalar in maximally symmetric $d + 1$ dimensional Lorentzian spacetime¹ is

$$R_d = \frac{d(d-1)}{\pm\ell^2} . \quad (4.1)$$

The de Sitter parameter ℓ defines dS or AdS as the induced metric on

$$-y_0^2 + y_1^2 + y_2^2 + y_3^2 \pm y_4^2 = \pm\ell^2 , \quad (4.2)$$

where y_A are coordinates of flat 5D space satisfying

$$ds^2 = -dy_0^2 + dy_1^2 + dy_2^2 + dy_3^2 \pm dy_4^2 .^2 \quad (4.3)$$

(Even with $A_\pm^\mu = 0$, the 5D MCM metric $g_{AB}^\pm = \text{diag}(\eta_{\mu\mu}, \chi_\pm^4)$ is not flat in the fifth coordinate.) We have inserted the \pm on ℓ^2 for concision in notation, but the radius of curvature in AdS is a number whose square is a negative number. That radius is timelike. Timelike or spacelike, the radius is called the de Sitter parameter,

¹Lorentzian topology is characterized by one sign different than others in the metric signature. Maximally symmetric Lorentzian spacetimes are Minkowski space, de Sitter space, and anti-de Sitter space. These correspond to \mathcal{H} and the respective physical slices of Σ^\pm . Maximal symmetry indicates that the Ricci tensor is completely determined by the Ricci scalar.

²Allowing for imaginary distances, (4.2) is the equation of a 5D sphere. Together with (4.3), these equations make clear what is meant when it is said that dS and AdS are spheres of spacelike and timelike radii: AdS₄ is a Lorentzian sphere of timelike radius in a space of two timelike and three spacelike dimensions. The $\{-+++\}$ metric signature in Σ^- specifies two timelike dimensions and three spacelike ones, so we have properly identified AdS₄ for the slices of Σ^- . Likewise, dS₄ is a Lorentzian sphere of spacelike radius in a space of one timelike and four spacelike dimensions, and it is fitting that the slices of the $\{-++++\}$ space Σ^+ are taken as dS₄.

and its square is inversely proportional to the Ricci scalar, as in (4.1). Minkowski space has $R = 0$ which is implied by any de Sitter parameter in the neighborhood of infinity, but, to get finite R in the neighborhood of infinity, ℓ would have to be the square root of an infinitesimal number. In other words, the radius would have to be unphysical. However, the square roots of numbers with non-vanishing fractional distance with respect to infinity were treated in [2], Section 6.2 therein. The main result of that treatment was that no real number can be the square root of a number in the neighborhood of infinity (such roots are complex), and the square root of an infinitesimal might follow a similar analytical program.

Beyond (4.1), the Ricci scalar is also defined as the contraction of the Ricci tensor, but it is not immediately obvious what Ricci tensors might contract as scalars in the neighborhood of infinity. These tensors must be classified, and applications of the attendant metrics toward the region around \emptyset should be studied. Even in the absence of such connections to the Ricci tensor, we might use the χ_{\emptyset}^4 coordinate to continue $R(\chi_{\pm}^4) = \chi_{\pm}^4$ beyond \mathcal{A} and Ω . This will allow an independent path for studying R in the neighborhood of infinity near \emptyset . In general, R being promoted to a function is a case of the generalized Brans-Dicke theory which will be briefly mentioned in Section 43. This is a natural framework in which to study curvature in the neighborhood of infinity.

If the Ω -brane marks the onset of curvature in the neighborhood of infinity, we must obtain

$$R_3(\Phi) = \mathcal{F}_0 \quad , \quad (4.4)$$

which is non-standard. If $\mathcal{F}_{\chi} \in \mathbb{F}$ does not have arithmetic defined (which is why they are called non-arithmetic numbers), then how might a function of a real number have such an output? To answer this question, we should identify the \mathbb{F} on one level of aleph with the \mathbb{N} on a higher level, as in [2].¹ The Ω -brane marks the termination of Σ^+ , at which point the level of aleph is expected to increase, so such a solution is well fitting. Overall, the \emptyset region of the unit cell very much remains an unknown territory on our map.

5 Continuous Particle Creation and Annihilation

In the lab, it is often observed that one particle will decay to two particles. For instance,

$$\psi \rightarrow \chi + \phi \quad . \quad (5.1)$$

¹The argument that the non-arithmetics on one level of aleph should be interpreted as the naturals on a higher level of aleph is presented in Remark 7.5.21 of [2].

However, there is no mechanism within the existing quantum theory by which the $\psi(x)$ function of one variable might smoothly evolve into the $\psi' = \chi(y) + \phi(z)$ function of two variables. Quantum theory gives us tools to determine an amplitude for a particle with k^μ to be found later as pair of particles with k'^μ and k''^μ , but the question of how we might get from here to there is not answered. Isham writes the following [69].

“Consider a scattering experiment in which two particles collide and turn into three particles. Ignoring internal and spin quantum numbers, the initial and final states could be described by wavefunctions $\psi(\mathbf{x}_1, \mathbf{x}_2)$ and $\psi(\mathbf{x}_1, \mathbf{x}_2, \mathbf{x}_3)$. However, it is by no means obvious what type of time-dependent Schrödinger equation could allow a function of two variables to evolve smoothly into a function of three variables.”

The $\widehat{\text{MCM}}$ operator was invented to affect the decay of the bounce state into two time arrow eigenstates [40]. The U_\pm universes are charted in the separate coordinates x_\pm^μ , but Isham points out that there does not exist an analytical equation to underpin and motivate

$$\widehat{\text{MCM}}|t_\star\rangle = |t_+\rangle + |t_-\rangle \quad .^1 \tag{5.2}$$

Fortunately, this is exactly the equation that we have now phrased as a change of basis operation between chronological and chirological time arrow states (Section 1.10.2). Since the $\psi \rightarrow \chi + \phi$ process in question deals with the *observation* of ψ and subsequently χ and ϕ , we are well motivated to invoke the physics of the MCM unit cell. The physics of time arrow basis states must be developed with the goal of solving this important and longstanding problem. Might we arbitrage a function of two variables from the change of basis and evolution operations on a function of one variable?

The following speculative mechanism explains how one might achieve the required dynamical increase of a function’s variables. Beginning with a chronological time arrow eigenstate ψ in \mathcal{H}_0 , one would represent it as a superposition in the chirological basis. Since Schrödinger evolution is a simultaneous process with chirological evolution, we might indicate non-decay with the superposition of chirological states being converted back to chronological states at t' . Decay would be indicated by the conversion of the states in the superposition back to the chronological basis, at times t' and t'' respectively, such that the resultant expression is a function of two different spatial variables in \mathcal{H}_1 . From $\psi(x)$ to $\chi(y) + \phi(z)$, y is obtained from the conversion of a chirological state at t' and z is obtained from conversion of another chirological state

¹One would bestow this universal equality with the causality inherent to decay by the incorporation of Heaviside functions. Such functions are said to impose *time ordering*.

at t'' . If one time basis is spinorial and the other is vectorial, the discrepancy between state representations in 2D and 3D bases may have applications to this problem.

6 Wavepackets Extending to Infinity

A standing problem in physics is the infinite spatial extent of wavepackets. We would like to construct analytical wavepackets localized in space, but this is not possible with standard mathematical tools. One way to summarize this problem is that the exponential function has no zeros on the real line, so wavepackets constructed from such functions must extend to $\pm\infty$. However, one of the main results to come of fractional distance analysis is that e^x actually does have an infinite number of zeros in \mathbb{R} :

$$x \in \widehat{\mathbb{R}} \implies e^{-x} = 0 \quad .^1 \tag{6.1}$$

This result should be extended to define a new framework for the analysis of wavepackets. Hypothetically, one would use the big parts of real numbers to model the lab scale across some spectrum of fractional distance while the wavepackets themselves would be defined with the small parts of real numbers so as to vanish outside of their local (comoving) neighborhoods.²

7 Dark Energy

Dark energy refers to a cosmological redshift of deep space supernovae consistent with an increasingly accelerating rate of cosmological expansion [34–36, 109]. However, increasing expansion is not consistent with any standard cosmological model. In standard cosmology, energy constraints are such that $E > 0$ causes the universe to expand forever, albeit under a decreasing rate of expansion. If $E = 0$, the universe will asymptotically stop expanding but never collapse. If the energy is negative (and the arrow of time points in the positive t direction), expansion will eventually stop, and the universe will recondense to a big crunch singularity. As a result, a theoretical energy called “dark energy” is supplemented to account for the additional expansion seen in the night sky. In this section, the main problem is to fit empirical dark energy survey data to a model in which the anomalous optical effect results from an interaction between two universes on opposite sides of a big bang-like singularity. This curve fitting exercise may be undertaken immediately without further preliminary

¹Recall that $\widehat{\mathbb{R}}$ is the union of the maximal neighborhood of infinity with every intermediate neighborhood of infinity: $\widehat{\mathbb{R}} = \mathbb{R}^1 \cup \{\mathbb{R}^{\mathcal{X}}\}$ for $\mathcal{X} \in (0, 1)$, as in Section 1.6.1.

²Recall that $\text{Big}(\aleph_{\mathcal{X}} + b) = \aleph_{\mathcal{X}}$ and $\text{Lit}(\aleph_{\mathcal{X}} + b) = b$, as in Section 1.6.1.

inquiry. Aside from that, this section contains a discussion of the MCM framework for dark energy. Related investigations are indicated as well.

There are two pictures in which the MCM solution to dark energy may be set. The original solution [31, 40] is a simplified picture of Newtonian gravitation on cosmological scales while the second picture is framed in GR [110]. The first picture avoids the issue of anomalous spatial expansion in a cyclic cosmology model. Periodicity is imposed along x^0 such that each big bang is the aftermath of a big crunch at the end of a previous cycle of cosmology.¹ Such events are called *big bounces*. On the far side of the bounce at the end of our present cycle lies another universe with gravitational mass. If there exists a timelike interval unbounded in the future so that we might continue to measure proper time through the collapse of all of spacetime in a big crunch at t_1 , then every $t > t_1$ labels a hypersurface of constant proper time having constant mass-energy M . Call the time of the next following bounce t_2 , and let t' be the midpoint of the interval (t_1, t_2) between two bounces. In a certain simplification, Gauss' law allows us to consider Newtonian gravitation across the bounce between our current hypersurface of constant proper time t_0 and the integrated mass \bar{M} of an M at every $t \in (t_1, t_2)$ as if \bar{M} was a point mass located at t' . Figure 22 shows a Newtonian potential energy landscape in which our hypersurface of the present is treated as a test mass. The interaction is treated as 1D along the t axis because the bottleneck at the bounce should wash out any information about spatial distributions of matter-energy beyond the bounce. Due to the present being deeper into the gravitational well of \bar{M} than supernovae on the past light cone, those images will appear to recede under acceleration in the rest frame of observers at t_0 . This recession should be identical to dark energy.

Since it is not clear what “time integrated mass” is, or what would be the mass-per-time integrated density, we might consider a potential energy landscape identical to that in Figure 22 between the singularity at t_1 and observers at (\vec{x}_0, t_0) rather than between \bar{M} at t' and observers' entire slice of constant proper time. In that case, the radial nature of the interaction will be preserved, and dark energy will continue to depend only on Δt . We might also appeal to infinite relative scale across levels of aleph to establish observers in the present as small test masses gravitating with a larger mass in the future *and* on a higher level of aleph. However, the original

¹The χ^4 periodicity across the unit cell is based in part on cyclic cosmology models such as loop quantum cosmology (LQC). Bojowald, the effective owner of the LQC theory, declared it dead in a 2013 talk. The record of this talk titled “Loop Quantum Cosmology: A Eulogy” [111] appears to have been deleted from the internet following a citation in [112] (excerpted here as Appendix C.) It is not clear if LQC died on its merits or if it died for its association with a pseudo-plagiarism scandal that concluded with Jerry Sandusky's 2011 child rape indictment (Appendix C). However, the MCM is not attached to the specifics of the LQC model. Even the requirement for a cyclic cosmology in any form has been called into question because interaction along χ^4 may suffice to support the MCM mechanism for dark energy without an additional interaction across a big crunch in the distant chronological future.

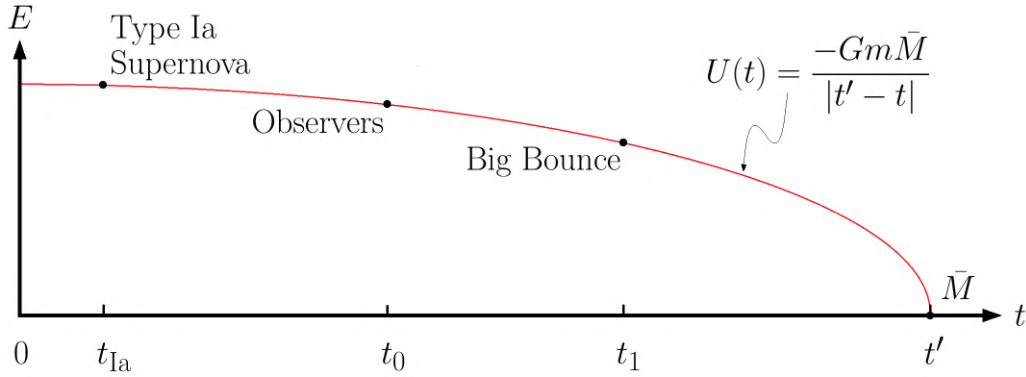

Figure 22: This figure depicts the Newtonian mechanism for MCM dark energy, mostly as it appeared in [31]. t_{Ia} is the proper time of a high redshift supernova in the dark energy survey. Such supernovae live on the past light cone of an observer with proper time t_0 . The upcoming bounce lies at t_1 . t' is the temporal midpoint of the cycle of cosmology beyond the bounce, and \bar{M} is a point mass representing the universe in the cycle beyond the bounce. The energy curve assumes that every slice of constant proper time in our present cycle of cosmology has the same mass m , so the energy between \bar{M} and the slices of constant proper time at t_{Ia} or t_0 differs only in the timelike separation $|t' - t|$. Observers in an inertial frame at t_0 will see objects at t_{Ia} appear to recede under acceleration because t_0 is deeper into \bar{M} 's gravitational well.

mechanism in [40] described interaction across a bounce, Figure 22 essentially, and we have introduced the integrated mass so that we might treat the mass of a surface of constant proper time as a test mass in the well of the future cosmology cycle.

Unfortunately, we have avoided a question about the integrated mass in our current cycle of cosmology. Namely, if objects gravitate toward objects in the distant future, integrated or not, then they should also gravitate toward objects in the near future. For instance, a mass at time t experiencing gravitation with another m at $t + \Delta t$ would also gravitate with m at $t + \varepsilon$. Such effects regard what is called the gravitational backreaction or self-force. This is one of the most difficult subjects in GR, and in physics.¹ In an ordinary study of GR, geodesics describe the path followed by a test mass that does not disturb the metric as it moves. Parameterized motion along a predetermined geodesic does not account for the disturbance in the spacetime background caused by the changing position of a larger mass. Testifying to the difficulty of the problem, the full equations of motion by which a mass disturbs its

¹The electromagnetic backreaction is given by the \ddot{x} term in the Abraham–Lorentz force $F_{\text{AL}} = m(\ddot{x} - \tau \dot{\ddot{x}})$, so a third derivative may be implied in the corresponding gravitational backreaction. This implied derivative puts that effect squarely within the purview of the MCM, even before its present context in the solution for dark energy.

local curvature as it moves (self-gravitates) were not found until 1997 [113, 114]. If dark energy is to be an interaction between a mass in the present and the same mass in the future, then the MCM solution is a long distance backreaction. The interaction is self-gravitation by definition.

The Newtonian gravitational potential energy is such that the r in

$$U(r) = \frac{-Gm_1m_2}{r} \quad , \quad (7.1)$$

is restricted to $x^i \subset x^\mu$ spatial separations, but we will assume for the purposes of defining a gateway into this problem that this expression holds for $r = x^0$. GR puts space and time on the same footing, so this hand-waving is not unreasonable. Given an energy landscape as in Figure 22, type Ia supernovae will be observed from an inertial frame at t_0 to recede under acceleration. Observers are deeper into the gravitational well of \bar{M} (a large mass in the future) than distant supernovae on the past light cone, so they will experience greater Newtonian gravitation toward it than will the supernovae. In observers' inertial rest frame, the difference in acceleration will be observed as supernovae receding under acceleration which increases as $(t_0 - t_{\text{Ia}})$ increases. Adding a second energy well associated with an earlier cycle of cosmology would compound the effect. The mechanism of the Newtonian solution to dark energy is that time is rarefied as the $1/r^2$ Newtonian force between universes pulls more strongly on late times than early times [31]. An observer in the present will accelerate toward the future more quickly than supernovae far back on his past light cone. The optical manifestation of this condition should be identical to the one attributed to dark energy: accelerating redshift which increases with the temporal displacement of optical images. The expansion of space in conventional dark energy theories is replaced with expanding time. Work remains to adapt the present Newtonian description to the language of GR, but it is likely that the simple description will be sufficient for a first order fit to the empirical data.

The energy landscape in Figure 22 neglects to account for the blueshift of photons falling into a gravitational well. Furthermore, gravitational time dilation¹ is such that clocks tick slower at lower gravitational potential while it seems like faster time in the present would be associated with acceleration toward the future. To account for such effects, one would add to Figure 22 an energy curve associated with an \bar{M} in the previous cycle of cosmology and set the cosmological scale for dark energy $|t_{\text{Ia}} - t_0|$

¹Consider the Schwarzschild metric $dr^2 \propto (1 - r_S/R)dt^2$ where r_S is the Schwarzschild radius, R is the distance from the singularity, t is the time on a clock at infinity, and τ is the time on a clock at R . Presently, r_S is like $|t' - t_1|$, and R is like $|t' - t_0|$. Without a second energy well due to a previous cycle of cosmology, a clock at t_{Ia} effectively measures Schwarzschild t while an observer's clock measures τ , which is necessarily slower than t .

to be such that emitters at t_{Ia} are at lower energy than observers at t_0 . As t_0 will accelerate more quickly toward future-directed \bar{M} than t_{Ia} , and likewise for t_{Ia} toward past-directed \bar{M} , the appearance of recession for observers at t_0 will not be disrupted by the amended energy landscape.

For the second theoretical mechanism for dark energy, we will use the metric in place of the loose Newtonian approximation. The second picture is like an interaction between \mathcal{H} -branes separated by \emptyset rather than two universes separated by a big bounce. A non-gravitational interaction is required because we have set the gravitational interaction between labeled branes to zero in Section 1.6.3. This was done to avoid gravitational collapse of the cosmological lattice, either by physical distance in the neighborhood of infinity or $U_{\text{grav}} \neq U_{\text{grav}}(\chi^4)$. In Section 1.7.3, it was shown that the scale factor \mathcal{C} between levels of aleph k and j changes the energy as

$$E_k = \mathcal{C}^2 E_j \quad , \quad (7.2)$$

and this is well suited to dark energy as a non-gravitational interaction across \emptyset rather than, or in addition to, interaction across a big bounce. The lower energy of redshifted photons can be used to determine a direction for increasing \mathcal{C} .

Preliminary metrical analysis predicts an effect like dark energy in the unit cell without requiring actual gravitation [110].¹ The Friedmann–Lemaître–Robertson–Walker (FLRW) line element

$$ds_{\text{FLRW}}^2 = -dt^2 + a^2(t)(dx^2 + dy^2 + dz^2) \quad . \quad (7.3)$$

describes flat expanding space. $a(t)$ is called the scale factor, and flat space stays flat as it expands because $a(t)$ is not a function of x^i . Borde, Guth, and Vilenkin describe the relation between $a(t)$ and redshift as follows [57].

“Consider a model in which the metric takes the form

$$ds^2 = dt^2 - a^2(t)d\mathbf{x}^2 \quad . \quad (7.4)$$

[...] From the geodesic equation one finds that a null geodesic in the metric, with affine parameter λ , obeys the relation

$$d\lambda \propto a(t)dt \quad . \quad (7.5)$$

Alternatively, we can understand this equation by considering a physical

¹After examining the metric, we will ask whether a gravitational-like metric must necessarily imply gravitation.

wave propagating along the null geodesic. In the short wavelength limit the wave vector k^μ is tangential to the geodesic, and is related to the affine parameterization of the geodesic by $k^\mu \propto dx^\mu/d\lambda$. This allows us to write $d\lambda \propto dt/\omega$, where $\omega \equiv k^0$ is the physical frequency as measured by a comoving observer. In an expanding model the frequency is red-shifted as $\omega \propto 1/a(t)$, so we recover [(7.5)].”

Photons propagate along null geodesics. A redshifted photon has lower frequency, so $\omega \propto 1/a(t)$ requires an accelerating increase in $a(t)$ to accommodate the observed accelerating increase in redshift. After the general solution for a in FLRW cosmology is obtained from Einstein’s equation under certain assumptions of homogeneity and isotropy, the result is that $a(t)$ decreases with time: the opposite of what is determined from deep space supernovae data [34–36, 109].

The MCM metric is

$$g_{AB}^\pm = \begin{pmatrix} g_{\alpha\beta}^\pm + \chi_\pm^4 A_\alpha^\pm A_\beta^\pm & \chi_\pm^4 A_\alpha^\pm \\ \chi_\pm^4 A_\beta^\pm & \chi_\pm^4 \end{pmatrix}, \quad (7.6)$$

from which we obtain an $A_\alpha = 0$ line element

$$ds_\pm^2 = -(d\chi^0)^2 + (d\chi^1)^2 + (d\chi^2)^2 + (d\chi^3)^2 + \chi_\pm^4 (d\chi^4)^2. \quad (7.7)$$

Comparing ds_{FLRW}^2 and ds_{MCM}^2 , χ_\pm^4 is a scale factor for the χ^4 part of g_{AB}^\pm .¹ Alternating sign for the scale factor follows from the \pm subscripting because χ_\pm^4 are oppositely positive- and negative-definite in the unit cell. Since we have not obtained a separable scale factor, as when $a(t) \neq a(x^i, t)$ is the scale factor for the x^i part of the FLRW metric (the MCM has a non-separable $a(\chi^4)$ scale factor acting on the χ^4 part), the behavior of the non-linear scale factor must be investigated. It must be verified that the sign in the scale factor indicates redshift rather than blueshift. Assuming redshift is indicated, $a(\chi_\pm^4) = \chi_\pm^4$ describes distance in the χ^4 direction increasing with increasing χ^4 . This effect was implemented along x^0 with the Newtonian \bar{M} energy landscape, and now χ^4 has replaced x^0 . The effect by which Newtonian gravitation toward the future rarefied chronological time is replicated with the non-separable scale factor on $(d\chi^4)^2$ rarefying chronological time. Furthermore, the increasing scale for χ^4 agrees with the scale we have associated with increasing levels of aleph.

In principle, we have demonstrated that a dark energy effect like gravitation be-

¹We have previously commented on the possibility for taking $g_{44}^\pm = \pm|\chi_\pm^4|^2$ to match the quadratic form of ϕ^2 in the KK metric. The present $ds^2 \propto a^2(t)$ context for the FLRW scale factor also suggests that $g_{44}^\pm = \pm|\chi_\pm^4|^2$ might be better than the $g_{44}^\pm = \chi_\pm^4$ appearing in (7.7).

tween universes may be derived from the MCM metric between \mathcal{H} -branes. We have described this effect with Newtonian gravity and as a non-gravitational metric effect, but a question is begged whether a metric like gravitation must imply gravitation itself. In other words, do the MCM branes gravitate after all? If so, it will be required to develop a mitigation preventing collapse such as Pauli degeneracy pressure between fermionic branes, for example. Perhaps infinitely increasing scale in the chirological future would imply a freefall-like equilibrium condition of metastable, eternal collapse-in-progress due to gravitation.

In the Newtonian model, a calculation is required to demonstrate that the energy term $U_{\text{grav}}(x^0)$ rarefies rather than compacts x^0 , or that the given effect produces redshift rather than blueshift. In other words, it must be verified which of expanding or contracting time should be associated with cosmological redshift. In the metrical model, a calculation is required to show that increasing scale along χ^4 induces redshift rather than blueshift. Any disagreements will be remedied with a sign change.

8 Vacuum Energy

In QM, \hat{x} is the position operator. In QFT, x is an index marking the field oscillator $\hat{\varphi}(x)$, and quantum oscillators have a famous zero point energy:

$$E = \frac{\hbar\omega}{2} . \tag{8.1}$$

Due to the infinite number of points x in any non-zero volume, the energy density of the vacuum must be infinite. Since it is differences in energy that matter for physics, this constant vacuum energy is usually ignored. The MCM suggests two possible methods for dealing with infinite vacuum energy. First, fractional distance analysis provides the $\widehat{\infty}$ object with which we can choose not to ignore vacuum energy and track transfinite energy differences with arithmetic axioms [2] such as

$$(\widehat{\infty} + a) - (\widehat{\infty} + b) = a - b . \tag{8.2}$$

However, a mathematical framework for handling infinite energies is disappointing because any connection to GR would cause the vacuum to collapse to a singularity. A second possible method for dealing with divergent vacuum energy would be to disassemble the foundations of QFT and reconstruct a theory in which vacuum oscillators oscillate jointly into Σ^\pm : one oscillation mode with $E = \hbar\omega/2$ and another with $E = -\hbar\omega/2$. Exotic models might be developed in which unequal probabilities for time arrow fluctuations lead to a non-vanishing but finite vacuum energy.

9 Spin Angular Momentum

If we associate the arrow of time with the direction of the p^0 component of the 4-momentum, then propagation through the unit cell is such that the direction of p^0 alternates between Σ^\pm and \mathcal{H} . As linearly independent degrees of freedom, x^0 and χ_\pm^4 cannot point in the same direction. Following the picture of a right turn between halves of the unit cell (Figure 4, Section 1.2.4), the p^μ vector must rotate. Thus, we may infer an angular momentum from $L = I\dot{\theta}$. One would attempt to associate the fundamental increment of spin \hbar with the total increment of angular momentum in the unit cell. The anomalous fractional increment $\hbar/2$ would be assigned to the Σ^\pm halves. Furthermore, it is known that torsion is required to conserve spin in GR, so one would attempt to correlate spin derived from the rotation of the momentum 4-vector with torsion in the g_{AB}^\pm metrics.

10 Spinor Structure from Spacetime

The Pauli matrices are a representation of the quaternions with

$$1 \rightarrow \mathbb{1} \quad , \quad \mathbf{i} \rightarrow -i\sigma_1 \quad , \quad \mathbf{j} \rightarrow -i\sigma_2 \quad , \quad \mathbf{k} \rightarrow -i\sigma_3 \quad , \quad (10.1)$$

or

$$1 \rightarrow \mathbb{1} \quad , \quad \mathbf{i} \rightarrow i\sigma_3 \quad , \quad \mathbf{j} \rightarrow i\sigma_2 \quad , \quad \mathbf{k} \rightarrow i\sigma_1 \quad . \quad (10.2)$$

The problem described in this section seeks to associate the Pauli algebra with the structure of spacetime by replacing the imaginary number in the timelike part of the Minkowski metric with a quaternion:

$$x^0 = ict \quad \longrightarrow \quad x^0 = \mathbf{q}ct \quad , \quad \text{where} \quad \mathbf{q} \in \{\mathbf{i}, \mathbf{j}, \mathbf{k}\} \quad . \quad (10.3)$$

Notation for a complex phase between x^0 and t was developed in Section 1.2.4, but here we will briefly re-motivate the convention.

The Lorentzian signature of Minkowski space is often taken as equivalent to the form of the Minkowski metric

$$g_{\mu\nu} = \begin{pmatrix} -c^2 & 0 & 0 & 0 \\ 0 & 1 & 0 & 0 \\ 0 & 0 & 1 & 0 \\ 0 & 0 & 0 & 1 \end{pmatrix} \quad . \quad (10.4)$$

Once the metric is defined, the differential element is

$$ds^2 = g_{\mu\nu} dx^\mu dx^\nu \quad . \quad (10.5)$$

However, in the underlying theory of differential geometry pioneered by Riemann, we have a differential line element ds as the fundamental descriptor of curvature on manifolds. For physics, the quantity ds^2 is more useful, but everything needed for the mathematical construction of 4D manifolds with Riemannian curvature is encoded on

$$ds = a_0x^0 + a_1x^1 + a_2x^2 + a_3x^3 \quad , \quad \text{with} \quad a_\mu \in \mathbb{R} \quad . \quad (10.6)$$

To generate Lorentzian structure at this level, and specifically the Minkowski metric in (10.4), we set $x^0 = \gamma ct$ where γ has the property $\gamma^2 = -1$. Therefore, we may obtain the correct matrix representation of the $g_{\mu\nu}$ tensor if we use either of $x^0 = ict$ or $x^0 = \mathbf{q}ct$ since $i^2 = \mathbf{q}^2 = -1$.

If we distinguish Σ^\pm so that the Lorentzian structure of their respective dS and AdS slices are given by \mathbf{q}_1 and $\mathbf{q}_2 \neq \mathbf{q}_1$, the limit of small χ_\pm^4 as Σ^\pm approach a shared boundary at \mathcal{H} is also the limit where the individual complex plane analogues will come into contact with a third embedding dimension. In other words, the quaternions in Σ^\pm are only indistinguishable from the imaginary number until they come to an X-point at \mathcal{H} or \emptyset . The algebra of the Pauli matrices is exactly the algebra of the quaternions, so one would seek to extract the Pauli algebra as a consequence of the metric in \mathcal{H} being defined as a superposition of the $\chi_\pm^4 \rightarrow 0$ limits in Σ^\pm . For example, given

$$x_+^0 = \mathbf{j}ct_+ \quad , \quad \text{and} \quad x_-^0 = \mathbf{k}ct_- \quad , \quad (10.7)$$

these two variables would not commute. Instead, they would anti-commute. Depending on the means by which physics in \mathcal{H} is determined from the physics in Σ^\pm , one might obtain a Hamiltonian containing a product of such non-commuting variables. In the $\{+ - - -\}$ Lorentzian signature convention calling for

$$\begin{aligned} x_+^1 &= \mathbf{j}x_+ & x_-^1 &= \mathbf{k}x_- \\ x_+^2 &= \mathbf{j}y_+ & \text{and} & & x_-^2 &= \mathbf{k}y_- \\ x_+^3 &= \mathbf{j}z_+ \quad , & & & x_-^3 &= \mathbf{k}z_- \quad , \end{aligned} \quad (10.8)$$

the appearance of a product of non-commuting variables is especially easy to imagine when defining \mathcal{H} through a matching condition on Σ^\pm because the quaternions are attached to the spatial variables. In QM, a classical Hamiltonian $H = xp$ is quantized

as

$$H = xp = \frac{1}{2}(xp + px) \quad \longrightarrow \quad \hat{H} = \frac{1}{2}(\hat{x}\hat{p} + \hat{p}\hat{x}) \quad . \quad (10.9)$$

because neither of the $\hat{x}\hat{p}$ or $\hat{p}\hat{x}$ products can be favored. A similar lack of distinction between $x_+^i x_-^i$ and $x_-^i x_+^i$ might be used in the present case to invoke the Pauli matrix commutator

$$[\sigma_j, \sigma_k] = 2i\varepsilon_{jkl}\sigma_l \quad . \quad (10.10)$$

In turn, this commutator algebra might drive the steering by right angles between successive Σ^\pm which was prescribed earlier for avoiding metric signature discrepancies.

Fundamentally, integer QM spin states have classical counterparts while half-integer spin states do not. Since we have taken the \mathcal{H} -brane as the domain of quantum mechanics, we are well motivated to attempt to derive the half-integer spin algebra as the limiting algebra of the coming together of Σ^\pm at \mathcal{H} .

11 Antisymmetry for Fermionic Wavefunctions

There is no theoretical motivation for the antisymmetry of fermionic wavefunctions. It is inserted into the framework of QM artificially to force agreement with experiment. Therefore, we should seek to motivate this antisymmetry from theory. The relative phase conventions for real, imaginary, complex, and oppositely signed χ_\pm^4 seem well suited to such a development. The reversed time arrow between Σ^\pm , the association of \hat{i} with \emptyset , the piecewise right turns of χ_\pm^4 (Figure 4, Section 1.2.4), and the metric signature discrepancy between Σ^\pm all provide leads which may have applications toward motivating fermionic asymmetry from first principles. The particle scheme in which fundamental fermions are constructed from single spacetime quanta while fundamental bosons are constructed from pairs may also have applications toward a theoretical motivation for symmetry and antisymmetry in bosons and fermions.

12 Time Arrow Spinors

In Section 1.10.2, MCM states were given as eigenstates of a time arrow operator: either the chronological \hat{T} or the chirological $\hat{\mathcal{T}}$. The shared eigenvalue spectrum $\{+1, 0, -1\}$ indicated chronological $\{x_+^0, x^0, x_-^0\}$ or chirological $\{\chi_+^4, \chi_\emptyset^4, \chi_-^4\}$. If the time arrow operators are like an \hat{S}_z operator, then we find a pair of spin-1 time states. In [85], however, time arrow spinors having spin-1/2 were developed as follows.

“Through conservation of momentum we derive two times t_\pm pointing in opposite directions from the big bang. We obtain the superposition time

t_* from t_{\pm} via a quantum mechanical argument: the observer is unable to determine if he is in the universe with forward time or backward time. To an observer in either universe, time in that universe is forward, and the other is backward. This is in complete analogy with quantum mechanical spin: if the quantum observer cannot determine whether a two-state spin system is in the spin-up or spin-down eigenstate then he must write the state as a superposition

$$|\psi_{\pm}\rangle = c_{\uparrow}|\uparrow\rangle + c_{\downarrow}|\downarrow\rangle . \quad (12.1)$$

Adapting from electron to universe, we write

$$|t_{*}\rangle = c_{+}|t_{+}\rangle + c_{-}|t_{-}\rangle . \quad (12.2)$$

with eigenspinors

$$|t_{+}\rangle = \begin{pmatrix} 1 \\ 0 \end{pmatrix} , \quad \text{and} \quad |t_{-}\rangle = \begin{pmatrix} 0 \\ 1 \end{pmatrix} .” \quad (12.3)$$

The observer’s inability to distinguish a positive time universe from a negative time one was the original motivation for defining time in the present as a superposition of positive and negative time:

$$|t_{*}\rangle = |t_{+}\rangle + |t_{-}\rangle . \quad (12.4)$$

This was also the main thinking in [40] when writing

$$|\text{bounce}\rangle = |t_{+}\rangle + |t_{-}\rangle . \quad (12.5)$$

Both are in analogy with

$$|S_x; +\rangle = \frac{1}{\sqrt{2}}|\uparrow\rangle + \frac{1}{\sqrt{2}}|\downarrow\rangle , \quad \text{or} \quad |S_x; -\rangle = -\frac{1}{\sqrt{2}}|\uparrow\rangle + \frac{1}{\sqrt{2}}|\downarrow\rangle , \quad (12.6)$$

meaning that spin-up and spin-down in the \hat{x} direction may be expressed as independent linear combinations of \hat{S}_z eigenstates. The reason for identifying $|t_{*}\rangle$ with $|\text{bounce}\rangle$ was that the bounce should be the state of the present when the bounce happens. Subsequently, these states have been disassociated as chronological and chirological states. To motivate the disassociation on the same grounds as the former association, one would identify $|\text{bounce}\rangle$ with $t = \infty$ such that an observer’s finite proper time in $|t_{*}\rangle$ could never be that time. Presently, the spin-1/2 basis is not such

that there should exist an eigenstate having eigenvalue 0. Time arrow eigenspinors return ± 1 to their respective time operators, so clarification is required whether or not a complete time arrow basis has two states in it, or three. In Section 13, we will describe an MCM-specific supersymmetry rotation which might help resolve whether time states ought to be fermions or bosons, if a simpler resolution cannot be obtained.

The framework for bosonic MCM cosmology states in Section 1.10.2 must be reconciled with the spin-1/2 time arrow spinor states that are the topic of this section. The new mechanism for quantum gravity in Section 1.10.3 does not require that there are three states in the completeness relation since we have ignored one by choosing $c_\star = c_\emptyset = 0$. Neither do (12.4) or (12.5) require a third state with a zero eigenvalue. Indeed, the representations

$$|x^0\rangle = |x_+^0\rangle + |x_-^0\rangle \quad , \quad \text{and} \quad |\chi_\emptyset^4\rangle = |\chi_+^4\rangle + |\chi_-^4\rangle \quad , \quad (12.7)$$

show that $|x^0\rangle$ and $|\chi^4\rangle$ cannot be eigenstates of the \hat{T} and $\hat{\mathcal{T}}$ operators if

$$\hat{T}|x_\pm^0\rangle = \pm|x_\pm^0\rangle \quad , \quad \text{and} \quad \hat{\mathcal{T}}|\chi_\pm^4\rangle = \pm|\chi_\pm^4\rangle \quad . \quad (12.8)$$

Any operator's eigenstates must be orthogonal, so one can never be expressed as a linear combination of the others. On the other hand, the expressions

$$|x^0\rangle = |\chi_+^4\rangle + |\chi_-^4\rangle \quad , \quad \text{and} \quad |\chi_\emptyset^4\rangle = |x_+^0\rangle + |x_-^0\rangle \quad , \quad (12.9)$$

say that x^0 is a superposition of the adjacent χ_\pm^4 times while χ_\emptyset^4 is a superposition of the adjacent x_\pm^0 times. These expressions do not preclude the existence of a zero eigenvalue for \hat{T} or $\hat{\mathcal{T}}$, and each forms a valid representation of $|t_\star\rangle = |t_+\rangle + |t_-\rangle$.

As an additional cog in the works, consider a c_\star term added to the right side of

$$\widehat{\text{MCM}}|b\text{ounce}\rangle = c_+|t_+\rangle + c_-|t_-\rangle \quad , \quad (12.10)$$

so that we obtain

$$\widehat{\text{MCM}}|b\text{ounce}\rangle = c_+|t_+\rangle + c_-|t_-\rangle + c_\star|t_\star\rangle \quad . \quad (12.11)$$

This was (1.10.26) in Section 1.10.2. If $|t_\star\rangle$ is combination of $|t_\pm\rangle$, (12.11) reduces to (12.10) times a constant, we will have obtained obtain nothing new, and a zero eigenvalue is not suggested. Therefore, work is required to sufficiently parse the desired time arrow physics in terms of the chronological and chirological time states.

Following the structure of ordinary spin-1/2 states, we might introduce three time

arrow operators \hat{T}_+ , \hat{T}_0 , and \hat{T}_- corresponding to measurements of time-up or time-down in the $\{x_+^0, x^0, x_-^0\}$ directions. These would mimic the \hat{S}_i operators as

$$\begin{aligned}\hat{T}_+|\psi; \hat{\Phi}\rangle &= \pm|\psi; \hat{\Phi}\rangle \\ \hat{T}_0|\psi; \hat{\pi}\rangle &= \pm|\psi; \hat{\pi}\rangle \\ \hat{T}_-|\psi; \hat{2}\rangle &= \pm|\psi; \hat{2}\rangle .\end{aligned}\tag{12.12}$$

Then we would introduce a similar algebra for $\hat{\mathcal{T}}_i$. Following an analogy with \hat{S}_i , (12.12) begs the question of a \hat{T}^2 operator commuting with the \hat{T}_i such that

$$[\hat{T}_i, \hat{T}_j] = \varepsilon_{ijk}\gamma\hat{T}_k \quad , \quad \text{and} \quad [\hat{T}_i, \hat{T}^2] = 0 \quad .\tag{12.13}$$

If two observable operators commute, the eigenstates of those operators should be described by two quantum numbers. Perhaps the time arrow operators supposed in Section 1.10.2 represent respective commuting observables so that simultaneous eigenstates might have two quantum numbers specifying an arrow of time (with a given scale) and time-up or time-down with respect to that arrow. Overall, the language for time arrow eigenstates is one of the most promising problems presented in this paper due to its high potential for immediate productive work toward a well-defined conclusion.

Time arrow spinor states are well developed enough that we have obtained a Hamiltonian rather than only supposing that one should exist. The MCM Hamiltonian is based on the physics of the Stern–Gerlach experiment that separates spin superpositions according to their eigenstates (or combines them in its elaborate variants [85].) It was presumed that spinor-valued time states propagating in the MCM lattice, described as a **time circuit** in [85], would similarly separate and recombine as part of a general milieu. Spin-1/2 angular momentum states in the Stern–Gerlach experiment obey the Pauli equation

$$i\hbar\frac{\partial}{\partial t}|\psi_{\pm}\rangle = \left\{ \frac{1}{2m} \left[(\hat{\mathbf{p}} - q\mathbf{A})^2 - q\hbar\boldsymbol{\sigma}\cdot\mathbf{B} \right] + qA_0 \right\} |\psi_{\pm}\rangle \quad ,\tag{12.14}$$

where

$$A_{\mu} = (A_0, \mathbf{A}) \quad , \quad \mathbf{B} = \nabla \times \mathbf{A} \quad , \quad \text{and} \quad \hat{H}_{\text{SG}} = -\frac{q\hbar}{2m}\boldsymbol{\sigma}\cdot\mathbf{B} \quad .\tag{12.15}$$

The \hat{H}_{SG} part was adapted to \hat{H}_{MCM} for time arrow spinors in the lattice as

$$i\hbar \frac{\partial}{\partial \chi^4} |\psi_{\pm}\rangle = \left(\hat{H} - \underbrace{ip^0 \mathbf{u}_1 \cdot \phi \mathbf{u}_2}_{\hat{H}_{\text{MCM}}} \right) |\psi_{\pm}\rangle , \quad (12.16)$$

where \mathbf{u}_1 and \mathbf{u}_2 are two quaternions, and ϕ is the scalar field in the fifth diagonal position of the KK metric which we have identified with χ^4 . \hat{H}_{MCM} has replaced \hat{H}_{SG} , and we have condensed the remainder of the Hamiltonian down to \hat{H} to avoid a question about the analogue of the kinematical momentum.

The steps to obtain this equation for \hat{H}_{MCM} acting on time arrow spinors were as follows. The $|\psi_{\pm}\rangle$ momentum spinor was replaced with the $|t_{\pm}\rangle$ time spinor. We have rewritten the Pauli matrices with quaternions, as in Section 10. The substitutions

$$1 \rightarrow \mathbb{1} , \quad \mathbf{i} \rightarrow -i\sigma_1 , \quad \mathbf{j} \rightarrow -i\sigma_2 , \quad \mathbf{k} \rightarrow -i\sigma_3 , \quad (12.17)$$

allow us to write

$$\mathbf{u} = a\mathbf{i} + b\mathbf{j} + c\mathbf{k} \quad \longrightarrow \quad \boldsymbol{\sigma} = i\mathbf{u} . \quad (12.18)$$

We have replaced the electric charge q with the energy p^0 . Opposite energy in the two universes mimics opposite charge in the Stern–Gerlach apparatus. The energy of a complete universe is taken as one quantum in line with the electron’s single quantum of charge. Following the canonical prescription, p^0 quantizes as $\hat{p}^0 = -i\partial_0$, which is the time derivative in Schrödinger’s equation (up to a sign likely associated with metric signature.)¹ To avoid this double use, we have changed the time derivative on the left of (12.16) to ∂_4 , but we might have alternatively replaced q with p^4 which would act on ϕ through $\phi^2 = \chi^4$. These cases for p^0 and p^4 should be complementary MCM Schrödinger equations, as was discussed extensively in [85]. Finally, the magnetic field \mathbf{B} is replaced with the KK scalar field upgraded to a vector-like quantity by multiplication with \mathbf{u}_2 . (The case of $\mathbf{B} \rightarrow \phi^2 \mathbf{u}$ was also considered in [85].)

The MCM Hamiltonian and its physics require further study. In the case where the quaternions in \hat{H}_{MCM} acquire non-unit magnitudes as in the ontological basis, first analysis in [85] shows that the expected energy ratios $E_{\text{MCM}}^-/E_{\text{MCM}}^+$ are remarkably like the $E_{\text{NRR}}/E_{\text{RR}}$ ratios observed in the negative frequency experiments of Rubino et al. [43, 45]. The latter ratio is the energy of negative resonant photons divided by that of resonant photons.

To the knowledge of this writer, exciting new algebraic structures developed in [85] have not appeared elsewhere in the literature. They are obtained by extension of

¹Note that quantization of the p^0 component of the 4-momentum as $\hat{p}^0 = i\hbar c \partial_t$ allows us to write the time-dependent Schrödinger equation as $\hat{p}^0 |\psi\rangle = c\hat{H} |\psi\rangle$.

the $x^0 = \mathbf{u}ct$ protocol for replacing the imaginary number with quaternions (Section 10). We will replace the imaginary number in the plane wave complex exponential as $e^{i\omega t} \rightarrow e^{\mathbf{u}\omega t}$. Then we will bring those waves into spinors and increase matrix complexity by converting the quaternions to nested Pauli matrices. Given a two component spinor wave

$$|\psi\rangle = e^{ikx} \begin{pmatrix} \psi_1 \\ \psi_2 \end{pmatrix}, \quad (12.19)$$

a quantum number is added to specify spin-up and -down as

$$|\psi; +\rangle = e^{ikx} \begin{pmatrix} \psi_1 \\ 0 \end{pmatrix}, \quad \text{and} \quad |\psi; -\rangle = e^{ikx} \begin{pmatrix} 0 \\ \psi_2 \end{pmatrix}. \quad (12.20)$$

For time spinors, we will use ψ and ξ to specify chronological and chirological eigenstates:

$$|\psi\rangle = e^{\mathbf{u}_1 kx} \begin{pmatrix} \psi_1 \\ \psi_2 \end{pmatrix}, \quad \text{and} \quad |\xi\rangle = e^{\mathbf{u}_2 \beta x} \begin{pmatrix} \xi_1 \\ \xi_2 \end{pmatrix}. \quad (12.21)$$

To demonstrate what appears to be new matrix structure with an example, assume $\mathbf{u}_1 = \mathbf{j}$. Ignoring the ψ_1 part of $|\psi; +\rangle$ to use

$$\mathbf{j} \longrightarrow -i\sigma_2 = -i \begin{pmatrix} 0 & -i \\ i & 0 \end{pmatrix}, \quad \text{and} \quad 1 \longrightarrow \mathbb{1} = \begin{pmatrix} 1 & 0 \\ 0 & 1 \end{pmatrix}, \quad (12.22)$$

we may write

$$|\psi; +\rangle = \begin{pmatrix} e^{\mathbf{j}kx} \\ 0 \end{pmatrix} = \begin{pmatrix} C + \mathbf{j}S \\ 0 \end{pmatrix} = \begin{pmatrix} \mathbb{1}C - i\sigma_2 S \\ 0 \end{pmatrix} = \begin{pmatrix} C & -S \\ S & C \\ 0 & 0 \\ 0 & 0 \end{pmatrix}. \quad (12.23)$$

This additional layer of matrix complexity is likely to support new channels for the flow of quantum information.

An additional system not described in [85] preserves the imaginary number in the plane wave exponent but allows the ontological labels to specify quaternion phase on time:

$$t \rightarrow t\mathbf{u} \quad \Longrightarrow \quad e^{i\omega t} \rightarrow e^{i\omega t\mathbf{u}}. \quad (12.24)$$

In this latter convention for complementing imaginary phase with quaternion phase, the program for finding the Pauli algebra in the structure of spacetime (Section 10)

would revolve around $x^0 = ict\mathbf{u}$ rather than $x^0 = \mathbf{u}ct$. The identities

$$\sin(i\theta) = i \sinh(\theta) \quad , \quad \text{and} \quad \cos(i\theta) = \cosh(\theta) \quad (12.25)$$

give another example of new matrix complexity as

$$e^{i\omega t \mathbf{j}} = \cos(i\omega t) + \mathbf{j} \sin(i\omega t) = \mathbb{1}Ch - i\sigma_2(iSh) = \begin{pmatrix} Ch & -iSh \\ iSh & Ch \end{pmatrix} \quad , \quad (12.26)$$

where Ch and Sh are $\cosh(\omega t)$ and $\sinh(\omega t)$. This can be further complicated with the imaginary number replaced as well. For example,

$$\begin{aligned} e^{i(kx - \omega t \mathbf{j})} &= e^{i k x} e^{-\omega t \mathbf{j}} \\ &= e^{i k x} e^{-\omega t \mathbf{k}} \\ &= (C(kx) + \mathbf{i}S(kx))(C(\omega t) - \mathbf{k}S(\omega t)) \\ &= (\mathbb{1}C(kx) - i\sigma_1 S(kx))(\mathbb{1}C(\omega t) + i\sigma_3 S(\omega t)) \\ &= \begin{pmatrix} C(kx) & -iS(kx) \\ -iS(kx) & C(kx) \end{pmatrix} \begin{pmatrix} iC(\omega t)S(\omega t) & 0 \\ 0 & -iC(\omega t)S(\omega t) \end{pmatrix} \\ &= \frac{1}{2} \sin(2\omega t) \begin{pmatrix} i \cos(kx) & -\sin(kx) \\ \sin(kx) & -i \cos(kx) \end{pmatrix} . \end{aligned} \quad (12.27)$$

The utility of such structures toward new channels in quantum algebras must be evaluated.

13 Supersymmetry

The supersymmetric standard model of particle physics is well loved because the coupling constants of three of the four forces are unified at a certain energy (Figure 14, Section 1.9.4). A model is said to be supersymmetric if fundamental bosons have fermionic partners and fundamental fermions have bosonic partners. For each particle, one says there exists a supersymmetric *sparticle*. Therefore, we should consider the decompositions of chronological/chirological time arrow eigenstates as superpositions of chirological/chronological ones in the context of the MCM model of spin spaces (Section 1.4). This may help clarify the question of a bosonic or fermionic eigenvalue spectrum, either $\{+1, 0, -1\}$ or $\{+1, -1\}$, for chronological \hat{T} and chirological $\hat{\mathcal{T}}$.

Firstly, one considers the notion that if every time arrow eigenstate can be de-

composed into a superposition of relative positive and negative time states, then one might construct a symmetric unit cell about whichever time eigenstate was decomposed. In essence, we might take any time as the time in an \mathcal{H} analogue and treat the positive and negative parts of that time as χ_{\pm}^4 analogues spanning Σ^{\pm} analogues. Considering the case where we take a chirological time as the x^0 analogue, we would establish a system in which the equations for chronological time are like the equations for chirological time. Obviously, this mimics the usual supersymmetric notion of equality between equations for force and matter, or bosons and fermions. An integral concept in supersymmetry is the continuation of an ordinary Lie algebra onto what is called a super algebra, and that should provide guidance for the structure suggested here. Furthermore, if x_+^0 (for example) might be decomposed as some other variants of χ_{\pm}^4 not present in the unit cell, then we establish a fractal model of infinite self-similarity.¹ Arkani-Hamed has made a comment about how the spin-1 case for the Higgslike particle requires a “Russian doll” model of nested bosons [21], and the present suggestion is consistent with that analogy.

Consider a direct symmetry between bosons and fermions in the context of MCM spin spaces (Section 1.4). Given the space of spin-1/2 states

$$L^2(\mathbb{R}^3) \otimes \mathbb{C}^2 \quad \equiv \quad L^2(\mathbb{R}^3) \otimes \chi_{+\{0\}}^4 \otimes \chi_{-\{0\}}^4 \quad , \quad (13.1)$$

the decompositions

$$|\chi_{+\{0\}}^4\rangle = c_1|x_{+\{0\}}^0\rangle + c_2|x_{\{0\}}^0\rangle \quad , \quad \text{and} \quad |\chi_{-\{0\}}^4\rangle = c_3|x_{-\{0\}}^0\rangle + c_4|x_{\{0\}}^0\rangle \quad , \quad (13.2)$$

suggest

$$L^2(\mathbb{R}^3) \otimes \chi_{+\{0\}}^4 \quad \longrightarrow \quad L^2(\mathbb{R}^3) \otimes (c_1x_{+\{0\}}^0 \otimes c_2x_{\{0\}}^0) \otimes (c_3x_{-\{0\}}^0 \otimes c_4x_{\{0\}}^0) \quad . \quad (13.3)$$

The equations in (13.2) decompose the χ_{\pm}^4 in one unit cell in terms of their adjacent instances of chronological time. The result in (13.3) may be simplified by the $x \otimes x = x$ property of the tensor product as

$$L^2(\mathbb{R}^3) \otimes c_1x_{+\{0\}}^0 \otimes c_5x_{\{0\}}^0 \otimes c_3x_{-\{0\}}^0 \quad \equiv \quad L^2(\mathbb{R}^3) \otimes \mathbb{C}^3 \quad . \quad (13.4)$$

This is the MCM supposition for the structure of the state space of spin-1 particles, as in Section 1.4. Therefore, one might derive a fundamental symmetry (a supersymmetry) from the underlying symmetry between representations of abstract quantum

¹The structure by which each time arrow decomposition can be resolved on further time arrow decompositions has been said to make the MCM a fractal model of *infinite complexity*.

states in Hilbert space in the eigenbases of the chronological and chirological time arrow operators.

14 Representations of Quantum Algebras

We have introduced four new objects into quantum theory: the ontological basis vectors \hat{e}_μ . Cases for the association of these objects and their dyads with the four and sixteen generators of the Pauli and Clifford algebras should be explored. One would examine the utility of the ontological basis toward defining spinor/bispinor structure, e.g.:

$$\hat{\pi} \rightarrow \begin{pmatrix} \pi \\ 0 \\ 0 \\ 0 \end{pmatrix}, \quad \hat{\Phi} \rightarrow \begin{pmatrix} 0 \\ \Phi \\ 0 \\ 0 \end{pmatrix}, \quad \hat{2} \rightarrow \begin{pmatrix} 0 \\ 0 \\ 2 \\ 0 \end{pmatrix}, \quad \hat{i} \rightarrow \begin{pmatrix} 0 \\ 0 \\ 0 \\ i \end{pmatrix}. \quad (14.1)$$

As the Pauli matrices may be represented with quaternions, we would also explore cases for non-unit quaternion representations such as

$$\hat{\pi} \rightarrow \pi \mathbf{i}, \quad \hat{\Phi} \rightarrow \Phi \mathbf{j}, \quad \hat{2} \rightarrow 2 \mathbf{k}, \quad \hat{i} \rightarrow i \mathbb{1}, \quad (14.2)$$

and similar. A convention for non-unit quaternions replacing Pauli matrices was important in [85] for matching the ratio of energies in Σ^\pm to the energy ratio of the resonant and negative resonant photons observed by Rubino and McLenaghan et al. (Section 12) [43]. Additional sign conventions such as

$$\mathbf{u}_i \mathbf{u}_i = -1, \quad \text{and} \quad \mathbf{u}_i \mathbf{u}_j = \varepsilon_{ijk} \mathbf{u}_k, \quad (14.3)$$

may be useful for time arrow conventions. Quaternions (called \mathbb{H}) have the additional property

$$\mathbf{ijk} = -1, \quad (14.4)$$

which is not found in \mathbb{C} . However, a plane spanned by $\hat{1}$ and a unit quaternion $\hat{\mathbf{u}}$ must be exactly like \mathbb{C} in the absence of at least a third embedding dimension to invoke any algebraic properties not inherent to \mathbb{C} .

\mathbb{H} offers a geometric picture for thinking about tuples of complex numbers such as Pauli and Dirac spinors. The product $\mathbb{C} \otimes \mathbb{H}$ is a 5D space spanned by $\{\hat{i}, \hat{1}, \hat{\mathbf{i}}, \hat{\mathbf{j}}, \hat{\mathbf{k}}\}$ containing what are essentially four complex planes.¹ A point in this 5D space is

¹We take the overlap of the quaternion and complex identities as the identity, i.e.: $\hat{1} \otimes \hat{1} = \hat{1}$.

a tuple of four complex numbers when we associate $(1, \mathbf{q})$ with \mathbb{C} . Four complex numbers specify a Dirac spinor, and the product $\mathbb{C} \otimes \mathbb{H}$ follows the suggestions for bestowing time arrow spinors with new matrix complexity in Section 12. $\mathbb{C} \otimes \mathbb{H}$ may be useful for moving the Dirac equation into the bulk of Σ^\pm . Associating the sixteen ontological dyads with sixteen distinct Dirac bra-kets in the form $\langle \psi; \hat{e}_\mu | \psi; \hat{e}_\nu \rangle$, one would seek to make associations with the Clifford algebra and its sixteen generators. One notes that associating each ontological basis vector with a Dirac matrix gives

$$\gamma_5 \equiv \gamma_1 \gamma_2 \gamma_3 \gamma_4 = 2\hat{\pi}i\hat{\Phi} \quad , \quad (14.5)$$

which, in the limit of $\hat{\Phi}^k \rightarrow \hat{\Phi}^{\Delta k}$, associates the pervasive γ_5 matrix of the Dirac theory with the pervasive $2\pi i$ of complex analysis on a constant level of aleph. This feature and similar number-theoretical qualities derived from the association of the objects of standard quantum algebras with the ontological basis vectors should be investigated.

15 Mechanical Precession

Laithwaite has suggested that the anomalous precession of spinning discs [99] might be explained by the rate of change of the acceleration on the infinitesimal elements of the disc [98]. This context for the third derivative *directly* motivated the initial supposition that \hat{M}^3 should be a third derivative. In [3], we supposed that the apparent anti-gravity effects exhibited by spinning discs [99] might be attributed to a discrepancy between the time derivatives of the force in the past and future written as a power series in the fine structure constant. Although the EM interaction is unrelated, a potential relevance was inferred for the FSC because α should characterize the geometry of the unit cells exhibiting the assumed past/future discrepancy. We wrote the following [3].

“The apparent anti-gravity effects witnessed in Laithwaite’s gyro demonstration at the Royal Society [99] can be explained if there is a net force on \mathcal{H}_i due to contributions from the past and future. Using [*the time derivative of centripetal force* $\dot{F} = m\omega^3$,] we may write the following.

$$\begin{aligned} F_{net} \hat{\pi}_i &:= \sum_{n=1}^{\infty} \alpha^n (\dot{F} \hat{\pi}_{i+n} - \dot{F} \hat{\pi}_{i-n}) \\ &:= m\omega^3 \sum_{n=1}^{\infty} \alpha^n \Delta r_n \end{aligned} \quad (15.1)$$

If this sum is taken to the continuum limit as an integral over time, the inclusion of the differential element dt will give the correct units. A 20 kilogram wheel was spun at 2500 revolutions per minute. Precession lifted the wheel 1.5 meters in 3 seconds. This created a constant linear \hat{z} -momentum. Dividing the impulse by the time[,] we see the force of precession was about 3 newtons stronger than the gravitational force. Keeping terms to first order in α we derive a characteristic length scale for chiros.

$$\begin{aligned}\vec{F}_p &= m\omega^3\alpha\Delta r\hat{z} \\ 200 &= (20)(1.8 \times 10^7)\alpha\Delta r \\ \Delta r &\approx 10^{-4}\text{ meters}\end{aligned}\tag{15.2}$$

And that looks about right! Far from the nano-scale of quantum mechanics and far from the macro-scale of ordinary perception.”

The extent to which 10^{-4} is a special number cannot be overstated. If we had obtained any n other than $-6 \leq n \leq -3$, the 10^{-n} result could have been discounted immediately. Among the infinite possible integers, -4 is the most perfect one for new effects. The open question of new physics at this scale is discussed in [4, 5], for example. The calculation of this scale in [3] was the foundation for the arrangement of the unit cell being such that the metric in \mathcal{H} should be obtained by the difference of the metrics in Σ^\pm , as in Section 0.2. The mechanism for metrical differences followed from the above calculation in which the disc’s vertical rise is attributed to an asymmetry between contributions from the past and future. However, the problem of precession remains to be solved with formal equations of motion. Casting the motion of the disc as motion along a geodesic is likely to be productive because the expected vertical rise of the disc is already known.

16 The Advanced Electromagnetic Potential

This problem requires a breakdown and reanalysis of the foundations of the advanced and retarded potentials in Maxwell’s equations. Eventually, the Maxwellian EM potential 4-vector must be defined in terms of the A_\pm^μ in the metrics of Σ^\pm :

$$g_{AB}^\pm = \begin{pmatrix} g_{\mu\nu}^\pm + f(\chi_\pm^4)A_\mu^\pm A_\nu^\pm & f(\chi_\pm^4)A_\mu^\pm \\ f(\chi_\pm^4)A_\nu^\pm & f(\chi_\pm^4) \end{pmatrix} .\tag{16.1}$$

The following context for the advanced and retarded potentials appears in [115].

“In 1909 Walter Ritz and Albert Einstein (former classmates at the University of Zurich) debated the question of whether there is a fundamental temporal asymmetry in electrodynamics, and if so, whether Maxwell’s equations (as they stand) can justify this asymmetry. As mentioned above, the potential field equation

$$\frac{\partial^2 \phi}{\partial x^2} + \frac{\partial^2 \phi}{\partial y^2} + \frac{\partial^2 \phi}{\partial z^2} - \frac{1}{c^2} \frac{\partial^2 \phi}{\partial t^2} = -4\pi\rho \quad , \quad (16.2)$$

is equally well solved with either of two functions

$$\begin{aligned} \phi_1 &= \int \frac{\rho(x, y, z, t - r/c)}{r} dx dy dz & (16.3) \\ \phi_2 &= \int \frac{\rho(x, y, z, t + r/c)}{r} dx dy dz \quad , \end{aligned}$$

where ϕ_1 is called the retarded potential and ϕ_2 the advanced potential. Ritz believed the exclusion of the advanced potentials represents a physically significant restriction on the set of possible phenomena, and yet it could not be justified in the context of Maxwell’s equations. From this he concluded that Maxwell’s equations were fundamentally flawed, and could not serve as the basis for a valid theory of electrodynamics. Ironically, Einstein too did not believe in Maxwell’s equations, at least not when it came to the micro-structure of electromagnetic radiation, as he had written in his 1905 paper on what later came to be called photons. However, Ritz’s concern was not related to quantum effects (which he rejected along with special relativity), it was purely classical, and in the classical context Einstein was not troubled by the exclusion of the advanced potentials. He countered Ritz’s argument by pointing out (in his 1909 paper ‘On the Present State of the Radiation Problem’) that the range of solutions to the field equations is not reduced by restricting ourselves to the retarded potentials, because all the same overall force-interactions can be represented equally well in terms of advanced or retarded potentials (or some combinations of both). He wrote

‘If ϕ_1 and ϕ_2 are [*retarded and advanced*] solutions of the [*potential field*] equation, then $\phi_3 = a_1\phi_1 + a_2\phi_2$ is also a solution if $a_1 + a_2 = 1$. But it is not true that the solution ϕ_3 is a more general solution than ϕ_1 and that one specializes the theory by

putting $a_1 = 1, a_2 = 0$. Putting $\phi = \phi_1$ amounts to calculating the electromagnetic effect at the point x, y, z from those motions and configurations of the electric quantities that took place prior to the instant t . Putting $\phi = \phi_2$ we are determining the above electromagnetic effects from the motions that take place after the instant t . In the first case the electric field is calculated from the totality of the processes producing it, and in the second case from the totality of the processes absorbing it. If the whole process occurs in a (finite) space bounded on all sides, then it can be represented in the form $\phi = \phi_1$ as well as in the form $\phi = \phi_2$. If we consider a field that is emitted from the finite into the infinite, we can naturally use only the form $\phi = \phi_1$, precisely because the totality of the absorbing processes is not taken into consideration. But here we are dealing with a misleading paradox of the infinite. Both kinds of representations can always be used, regardless of how distant the absorbing bodies are imagined to be. Thus one cannot conclude that the solution $\phi = \phi_1$ is more special than the solution $\phi = a_1\phi_1 + a_2\phi_2$ where $a_1 + a_2 = 1$.’

“Ritz objected to this, pointing out that there is a real observable asymmetry in the propagation of electromagnetic waves, because such waves invariably originate in small regions and expand into larger regions as time increases, whereas we never observe the opposite happening. Einstein replied that a spherical wave-shell converging on a point is possible in principle, it is just extremely improbable that a widely separate set of boundary conditions would be sufficiently coordinated to produce a coherent in-going wave. Essentially the problem is pushed back to one of *asymmetric boundary conditions* [*emphasis added*].”

Although the unit cell is depicted in a rectangular representation, the picture of Einstein’s spherical wave converging on a point may be well suited to the MCM. The dark energy interaction described in Section 7 is radial about \emptyset , and it was supposed in Section 1.6.3 that higher levels of aleph might lie within \emptyset rather than beyond it due to physical curvature in the neighborhood of infinity. Either arrangement is likely to support spherical wave shells in place of the plane waves we have considered for rectangular representations of the unit cell.

The MCM solution for classical electrogravity (Section 18) follows from an assumed

condition

$$A^\mu|_{\mathcal{H}} = c_+ A_+^\mu|_{\Omega} + c_- A_-^\mu|_{\mathcal{A}} \quad , \quad (16.4)$$

where A_\pm^μ are like the ϕ_1, ϕ_2 in (16.3). The meaning of (16.4), which first appeared in [7], was that the usual A^μ in \mathcal{H} is defined non-locally by A_\pm^μ on the \mathcal{A} - and Ω -branes. However, non-locality is unusual in EM. To that end, Zeh makes a concise statement in [116] regarding the physics which suggests a revision to (16.4).

“Electromagnetic radiation will here be considered as an example for wave phenomena in general.¹ It may be described in terms of the four-potential A^μ , which in the Lorenz gauge obeys the wave equation

$$-\partial^\nu \partial_\nu A^\mu(\mathbf{r}, t) = 4\pi j^\mu(\mathbf{r}, t) \quad , \quad \text{with} \quad \partial^\nu \partial_\nu = -\partial_t^2 + \Delta \quad ,^2 \quad (16.5)$$

with $c=1$, where the notations $\partial_\mu := \partial/\partial x^\mu$ and $\partial^\mu := g^{\mu\nu} \partial_\nu$ are used together with Einstein’s [summation convention]. When an appropriate boundary condition is imposed, one may write A^μ as a functional of the sources j^μ . For two well-known boundary conditions one obtains the *retarded* and the *advanced* potentials,

$$\begin{aligned} A_{\text{ret}}^\mu &= \int \frac{j^\mu(\mathbf{r}, t - |\mathbf{r} - \mathbf{r}'|)}{|\mathbf{r} - \mathbf{r}'|} d^3\mathbf{r}' \quad (16.6) \\ A_{\text{adv}}^\mu &= \int \frac{j^\mu(\mathbf{r}, t + |\mathbf{r} - \mathbf{r}'|)}{|\mathbf{r} - \mathbf{r}'|} d^3\mathbf{r}' \quad . \end{aligned}$$

These two functionals of $j^\mu(\mathbf{r}, t)$ are related to one another by a reversal of retardation time $|\mathbf{r} - \mathbf{r}'|$ [sic]. Their linear combinations are solutions of [(16.5).]”

We may avoid an implication for non-locality in EM if we replace $A_+^\mu|_{\Omega}$ and $A_-^\mu|_{\mathcal{A}}$ in (16.4) with integrals as in (16.6). Therefore, we might write

$$A_\mu|_{\mathcal{H}} = c_+ A_\mu^+|_{\Sigma^+} + c_- A_\mu^-|_{\Sigma^-} \quad . \quad (16.7)$$

where $A_\pm^\mu|_{\Sigma^\pm}$ are integrated expressions. The second argument of j^μ would be adapted so that the given chronological retardation time describes chirological separation from \mathcal{H} . Considering only χ_\pm^4 , we would write

$$j^\mu(r, t \pm |r - r'|) \quad \longrightarrow \quad j_\pm^\mu(\chi_\pm^4, t \pm |\chi_\pm^4|) \quad . \quad (16.8)$$

¹Although the Schrödinger equation is the heat equation rather than the intuitive wave equation, it falls under the topic of wave phenomena in general.

² Δ is the Laplacian operator: $\Delta \equiv \nabla^2 \equiv \nabla \cdot \nabla$. The formula for $\partial^\mu \partial_\nu$ reflects the convention $x^0 = ict$.

In (16.6), the same j^μ appears in both integrals, but we would derive separate j_\pm^μ from separate A_\pm^μ through the formula

$$\square A_\pm^\mu = \frac{4\pi}{c} j_\pm^\mu . \quad (16.9)$$

Among the many conventions for \mathcal{H} and \emptyset considered in previous sections, and for Ω and \mathcal{A} , we have not considered that Ω and \mathcal{A} might be the limiting branes of Σ^\pm around \mathcal{H} so that the metric in \mathcal{H} is defined as a sum (or difference) of the metrics in Ω, \mathcal{A} . To compare this to the case where the metrics at $\chi_\pm^4 \rightarrow 0$ contribute to $g_{\mu\nu}$ (Section 0.2), the lack of space between \mathcal{H} and Ω, \mathcal{A} might be attributed to the scale of a certain level of aleph. In that case, (16.4) would not imply non-locality, the metric and the 4-potential in \mathcal{H} would both be assembled from the \mathcal{H} -adjacent limits of Σ^\pm , we would obtain a chronological retardation time rather than a chirological one, and the suggested integrals over j^μ would refer to x_\pm^i without \mathbf{r} being extended to χ_\pm^4 . Therefore, this convention for abutting Ω and \mathcal{A} should be added to the other ones proffered for future inquiry.

It should be noted how this convention highlights duality between \mathcal{H} and \emptyset , or between $|t_\star\rangle$ and $|\text{bounce}\rangle$. We have asked many times whether Ω and \mathcal{A} should be separated by an interval or a point, and we might say that they are separated by a point at \mathcal{H} and an interval at \emptyset .

17 Kaluza–Klein Theory

A rigorous survey of Kaluza–Klein theory is required, e.g.: material covered in [8–10, 117–119]. Particularly, the MCM condition that physical branes are defined at constant values of the fifth coordinate has been supposed to generate KKT’s cylinder condition in a natural way. This condition requires that 4D physics cannot depend on the fifth coordinate, but it remains to be shown rigorously that the MCM’s braneworld scenario is consistent with the requirements. Furthermore, analysis is needed to separate Kaluza theory from Kaluza–Klein theory in which the fifth dimension is given a compact topology and small dimension. Methods of Fourier expansion in the fifth dimension to remove the compact topology condition must be studied and compared to the unit cell. Overall, KKT is rich and well documented, but the MCM has merely adopted its metric without making a full analysis. Such analyses must be carried out. For instance, the MCM should be justified independently under the Campbell–Magaard theorem¹ [120, 121] without appealing the case of that theorem

¹The Campbell–Magaard theorem governs cases under which 4D solutions in GR may be embedded in flat 5D space.

implicit in KKT.

18 Classical Electrogravity

This problem regards the unification of electromagnetism and gravitation developed in [7]. The idea revolves around the definition of \mathcal{H} as a sum of contributions from Σ^\pm . The $g_{\mu\nu}$ metric in \mathcal{H} is taken as the sum (or difference) of the metrics in the 4D slices of Σ^\pm at their respective $\chi_\pm^4 \rightarrow 0$ limits, as in Section 0.2. In turn, the EM potential in \mathcal{H} was to be taken as a sum of potentials in Σ^\pm . Thus, one might use an antenna to impose a certain A^μ in \mathcal{H} which would define A_\pm^μ through the sum relationship. Since A_\pm^μ appear in the 5D metrics whose limits define $g_{\mu\nu}$, one should be able to steer $g_{\mu\nu}$ with an electrical antenna, or an array of them.

The sudden appearance of “hypersonic missiles” in late stage field testing in the years after the publication of [7] is taken as strong evidence that the MCM mechanism for electrogravity is sound. The lack of hypersonic missile technology approaching the late stage testing phase in the preceding years is explained by an important conceptual breakthrough related to electrogravity in [7].¹ Therefore, the work should be continued so as to obtain equations of motion by which the metric can be controlled with the EM potential. This problem is not expected to depend on \hat{M}^3 and should not amount to much more than crunching a large system of equations in a sufficient number of unknowns. This system of equations is laid out in [7], but a number of trivial deficiencies must be remedied before a physical, determinate system of equations can be presented.

19 ϕ^4 Quantum Field Theory

The MCM answers the fundamental problem of QFT with the spectrum of cosmological lattice modes (Section 0.3) [6], but the fundamental *applied* problem of QFT remains open. Namely, there is no analytical solution to

$$Z = \int D\phi \exp \left\{ i \int d^4x \left\{ \frac{1}{2} [(\partial\phi)^2 - m^2\phi^2] - \frac{\lambda}{4!} \phi^4 + J\phi \right\} \right\} , \quad (19.1)$$

where $\phi = \phi(x^\mu)$, $J = J(x^\mu)$, and $D\phi$ is the Feynman path integral measure. It is called ϕ^4 theory due to the presence of the ϕ^4 term in Lagrangian needed to permit interactions between field excitations.

¹Cook offers a fascinating account of classified electromagnetic propulsion technologies in [122]. A report of Alexander produced for NASA [123] contains related material which may be of further interest.

There are some mathematical problems, in the sense of rigor, with the notation for the infinite-dimensional integral over $D\phi$, but the present problem bears only on the integral in the exponential. Unresolved mathematical issues with $D\phi$ (Section 60) do not impede our ability to make predictions, but the lack of a general solution to the exponentiated integral is the major outstanding bottleneck on QFT's predictive capacity. In the absence of the anharmonic ϕ^4 term, the exponentiated integrand reduces to the Lagrangian density of the harmonic oscillator \mathcal{L}_{HO} added to a source term $J\phi$. In that case, integration by parts yields a well-known analytical solution. In the anharmonic case, the best we can do is the truncation of one or another infinite series to arbitrary order. The higher order terms become harder to calculate, and quantum field theorists would prefer an analytical solution in closed form. Since existing approximations for this integral rely on exponential series decompositions, one would examine cases for new methods reliant on the big exponential function E^x (Section 1.6.7) and new arithmetic axioms developed in fractional distance analysis [2].

Guralnik remarks on the ϕ^4 theory in [15].

“The (Euclidean) action is given by:

$$\int d^4x \left[\phi(x) \frac{(-\square + m^2)}{2} \phi(x) + g \frac{\phi^4(x)}{4} - J(x)\phi(x) \right] . \quad (19.2)$$

The (Euclidean) Schwinger Action principle:

$$\delta \langle t_1 | t_2 \rangle = \langle t_1 | \delta S | t_2 \rangle , \quad (19.3)$$

results in the equation:

$$(-\square + m^2)\phi(x) + g\phi^3(x) = J(x) . \quad (19.4)$$

Defining \mathcal{Z} as the matrix element of a state of lowest energy in the presence of the source at very large positive time measured against the ‘same state’ at very large negative time and again using the Schwinger action principle leads to:

$$\left[(-\square + m^2) \frac{\delta}{\delta J(x)} + g \left(\frac{\delta}{\delta J(x)} \right)^3 - J(x) \right] \mathcal{Z}(J) = 0 . \quad (19.5)$$

[...] A good way to make sense of this equation is examine it on a space time lattice with N space time points. This approach can be regarded as

the original definition of a quantum field theory which is realized only in the limit of vanishing lattice spacing. On a hyper-cubic lattice:

$$\square\phi_n = \sum_k (\phi_{n+\hat{e}_k} + \phi_{n-\hat{e}_k} - 2\phi_n) \quad , \quad (19.6)$$

where \hat{e}_μ is a unit vector pointing along the k direction, and, for convenience, the lattice spacing is set to 1. Since functional derivatives become ordinary derivatives at a lattice point the equation for \mathcal{Z} on the lattice is:

$$\left[-\sum_k (\phi_{n+\hat{e}_k} + \phi_{n-\hat{e}_k} - 2\phi_n) + m^2 \frac{d}{dJ_n} + g \left(\frac{d}{dJ_n} \right)^3 - J_n \right] \mathcal{Z}[J_1, J_2, \dots] = 0 \quad . \quad (19.7)$$

The space-time derivatives have served to make this an equation involving three lattice points with the functional derivatives becoming normal derivatives acting on the variable at the central lattice point.”

This result suggests an appropriately structured variant of the discretized ϕ^4 problem using $\mathcal{A}, \mathcal{H}, \Omega$ as the three lattice points where the functional derivatives reduce to ordinary derivatives. Guralnik continues as follows [15].

“Zero space-time dimension means that only one point exists and thus the lattice equation becomes:

$$g \frac{d^3 \mathcal{Z}}{dJ^3} + m^2 \frac{d\mathcal{Z}}{dJ} = \mathcal{Z} J \quad . \quad (19.8)$$

While loosing any space-time structure and thus the possibility of understanding all the interesting structure that occurs in the continuum limit, the above still maintains the non-linear nature of quantum field theory and the associated multiple solutions. Calculating solutions is now straightforward. While the finite dimensional case potentially has an infinite number of solutions before accounting for the collapse of the solution set, the current equation, representing ‘zero dimensional QFT’ only has three independent solutions. The solutions can be found easily by using series methods.”

Zero dimensional QFT is quantum mechanics. The reduction of the ϕ^4 QFT problem to that limiting case yields a third order equation similar to the MCM’s expected equation for $\partial^3 + \partial$. Therefore, the easily obtained solutions referenced by Guralnik must be carefully studied.

20 Stimulated Emission from the Vacuum

This problem regards the anomalous amplification reported by Rubino et al. in “Soliton-Induced Relativistic-Scattering and Amplification” [45], which was a follow up to Rubino and McLenaghan et al.’s earlier paper “Negative Frequency Resonant Radiation” [43]. The following appeared in [45] (most citations removed).

“If compared to the well-developed field of traditional light scattering in which the medium is at rest, little attention has been devoted to the physics of scattering from a moving medium, in particular from a relativistically moving medium. Here we consider the remarkable ability of solitons to generate a co-propagating refractive index inhomogeneity that propagates at relativistic speeds. The basics of scattering from a time-changing boundary were discussed in detail by Mendonça and co-workers (see e.g. [124] and references therein). Examples of such ‘time refraction’ have been predicted and observed from a moving plasma front and in waveguide structures. Recently, the nonlinear Kerr effect, i.e. the local increase of the medium refractive index induced by an intense laser pulse, was proposed to induce a moving refractive index inhomogeneity within a dispersive medium such as an optical fibre. The laser pulse induced relativistic inhomogeneity (RI) was then described in terms of a flowing medium in which the analogue of an event horizon may form and applications such a optical transistors have been proposed. Intense laser pulses are also known to scatter from the self-induced travelling RI: this self-scattering process leads to the resonant transfer of energy from the laser pulse to a significantly blue-shifted peak, often referred to as resonant radiation (RR) or ‘optical Cherenkov’ radiation. A recent discovery highlighted an additional scattered mode, further blue-shifted with respect to the RR, identified as a mode excited on the negative frequency branch of the medium dispersion relation and therefore named ‘negative resonant radiation’ (NRR).”

Firstly, the present author’s area is not experimental quantum optics. Secondly, this writer has undertaken only a cursory survey of the results in [43,45]. That being said, with frequency being the inverse of time, and with the negative frequency result following so closely on the heels of the MCM result regarding negative time, it is suggested that NRR is an MCM corollary result. Effects cited by Rubino et al. including time refraction, the analogue of an event horizon, and self-induced traveling relativis-

tic inhomogeneities seem to make qualitative allusions to the following.¹

- Dark energy as time refraction (described as time rarefaction in Section 7).
- The event horizon surrounding \emptyset between Σ^\pm .
- The \mathcal{H} -brane as a relativistic inhomogeneity disrupting the uniformity of $R_{AB}=0$ in Σ^\pm .

Even the title of Mendonça’s book, *Theory of Photon Acceleration* [124], makes a qualitative allusion to the boosted photons cited by Particle Data Group as making an allowance for the Higgslike particle to have spin-1 (Section 0.1) [27, 125, 126]. In general, the NRR result must be dissected and meticulously understood.

Before undertaking such a comprehensive study, an underlying mechanism has been supposed as the cause of the amplification reported in [45]. Lasers are monochromatic and in phase, so it is possible to create surfaces of phase lock within crossed laser beams. A surface of $|\mathbf{E}|=0$ would necessarily be solitonic because it represents the absence of the \mathbf{E} field. It would be a relativistic inhomogeneity in the crossed lasers due to the $|\mathbf{E}|=0$ condition juxtaposed with the broader $|\mathbf{E}|\neq 0$ laser field. The velocity of the $|\mathbf{E}|=0$ surface should be relativistic on the order of the beam group velocity. Vanishing \mathbf{E} is the boundary condition defining the surface of a piece of metal in classical EM, so the surface of phase lock might act as a virtual 2D metal foil in the path of the beam. We conjecture that the anomalous amplification in the negative frequency mode is the analogue of the photoelectric effect on the virtual foil. As a 2D surface, it is equipped with two oppositely signed normal vectors, one which is available to cancel the minus sign associated with negative frequency so that physical negative resonant photons might be observed with positive energy in the lab frame. One would attempt to describe this process as **stimulated emission from the vacuum**: a second quantized version of stimulated atomic emission in first quantization. Supporting such a mechanism, Rubino et al. write the following in [45] and [43] respectively.

“We have shown that a [*relativistic inhomogeneity*] amplifies and scatters light to higher frequencies. Likewise, if the probe pulse were to be reduced to the level of quantum fluctuations, we may expect to see the RI excite the vacuum states.”

“A process such as that highlighted here, that mixes positive and negative frequencies will therefore change the number of photons, leading to

¹It is not suggested that the authors of [43, 45] allude to the MCM’s elements. Rather, it is suggested that the physical context for negative resonant radiation overlaps with the MCM’s physical context.

amplification or even particle creation from the quantum vacuum.”

It must be investigated whether a theoretical mechanism for stimulated emission from the vacuum might be useful for describing such processes. If so, this should have direct application toward the construction of *overunity electrical devices* powered by vacuum energy.

21 The Dual Tangent Space

The dual tangent space was heavily emphasized in a previous MCM review [1]. The expected utility for this space is to facilitate smooth propagation from Σ^+ into Σ^- without being blocked by a singularity at \emptyset . As an example of a desirable mechanism, the interaction cross section between two large but oppositely signed momentum states is low even when the spatial overlap of the states is high. We might seek to develop a third representation beyond the position and momentum spaces in which the interaction cross section between a state transiting the unit cell and the singularity at \emptyset is also low. One “goes into the tangent space” from position space by taking the Fourier transform to obtain a momentum space representation. The usual framework of the Fourier transform and its inverse do not suggest a third representation beyond position/momentum space, but one would seek to associate some dual tangent representation with the χ^4 direction. In a familiar way, the binormal vector is perpendicular to the tangent space, and we might introduce another Fourier-like transform to **abstract space** as a third case beyond position or momentum space. This case would be associated with the dual tangent space as momentum space is associated with the tangent space. While such descriptions are not usual in physics, the additional derivative in the expected ∂^3 operator suggests structure beyond what is usually derived from the $\dot{p}=m\ddot{x}$ relationship.

22 Reverse Time in Quantum Field Theory

The early goal in treating the universe as a quantum particle¹ was to resolve an important question left unanswered by the standard model of particle physics: why does matter dominate over anti-matter in the universe? This question is called the mystery of the matter asymmetry [64]. The MCM solution is that a momentum-conserving pair of universes U^\pm are dominated by matter and anti-matter respectively so that there is no global excess. In essence, one universe is a particle, and the other is an anti-particle. The pair is said to come into existence at a fluctuation

¹This refers to work in [31] which predates the MCM model of particles in [6] by about three years.

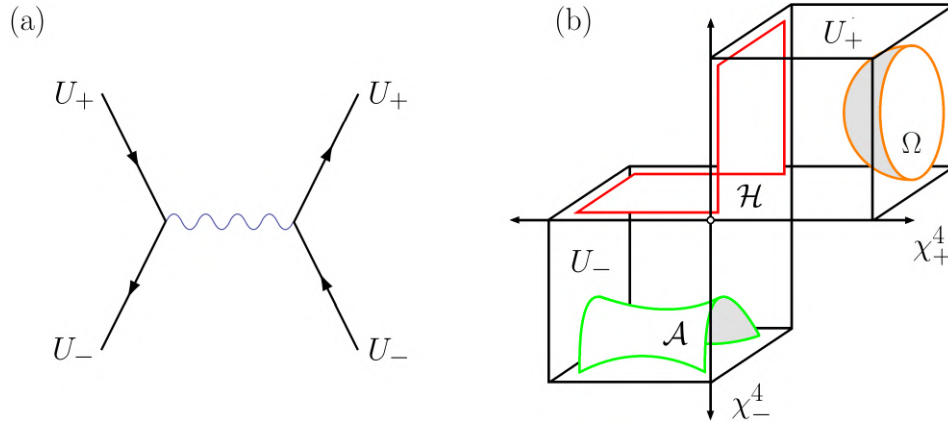

Figure 23: (a) A Feynman diagram for electron-positron annihilation is such that time increases to the right. It is labeled for comparison to the arrangement of time arrows in the unit cell. The reversed arrow on the U_- legs indicates that U_- is an anti-particle. If one pair of U_{\pm} labels were swapped and time was to point in the vertical direction, this annihilation diagram would become a scattering diagram whose time arrows are still evocative of the structure of the unit cell. (b) This figure demonstrates that the restriction to positive- or negative-definiteness for $\chi_{\pm}^4 \in \Sigma^{\pm}$ may be inherited from two unbounded intervals of χ_{\pm}^4 which exceed what is contained within the unit cell. By inserting another instance of the unit cell into the second and fourth quadrants, one exactly replicates the structure of the Feynman diagram.

called a big bang or big bounce. The problem described in this section calls for an investigation to determine the extent to which QFT's interpretation for particles and anti-particles moving oppositely through time might be useful for describing MCM cosmology states.

The model of electrons and positrons interacting by coming together along opposite motions through time should be well suited to two oppositely timed universes U^{\pm} coming together at a big bounce and then separating, as in Figure 23a. They annihilate to a photon-like bounce and then emerge from a null interval-analogue via a process like $\gamma \rightarrow e + p$. Ignoring the pre-bounce epoch, a pair of universes with opposite time arrows coming into existence is like the process for pair creation by vacuum fluctuations. The disjoint representation of the unit cell in Figure 23b enables an easy visualization of the particle scattering diagram as a cosmology process. For one transit of the unit cell, we have a universe coming into the null interval analogue, \mathcal{H} , from \mathcal{A} and then going back out toward Ω . Since the arrow of time points oppositely in χ_{\pm}^4 , this process should be associated with the left or right side of the scattering

diagram: half the path of U_+ and half that of U_- . The continuation of χ_{\pm}^4 beyond their respective positive and negative subsets in Σ^{\pm} (Figure 23b) describes the continued paths for U_{\pm} . A choice to represent the unit cell with Σ^{\pm} joined on \mathcal{H} or \emptyset corresponds to another choice between assembling U^{\pm} from one side of the Feynman diagram, or from opposite corners. In one case, U_{\pm} are separated by nothing, and in the other they are separated by the null interval. Indeed, the Feynman diagram suggests that we might complete the likeness by squeezing a second instance of the unit cell into the second and fourth quadrants of Figure 23b. We have previously made implicit reference to these quadrants when discussing $(\hat{M}^3)^{\dagger}$ and $\hat{\varphi}$ in Sections 1.2.4 and 1.2.5.

The MCM bouncing mechanism and unit cell are strikingly like the most famous Feynman diagram. To move forward with this correspondence, it must be determined which QFT processes are best suited to the modified model of cosmology. Feynman diagrams represent amplitudes, but it is not immediately obvious in what way an amplitude might describe our present universe in progress. However, the AdS/CFT correspondence is famously exciting despite the absence of any direct utility for it. Such *correspondences* are exciting in physics because they are believed to be important.

23 Absorber Theory

The Wheeler–Feynman absorber theory of classical electrodynamics [127–129] supposed the physical existence of advanced and retarded solutions to Maxwell’s equations. By doing so, they were able to accurately describe physics at almost all length scales under the assumption that particles do not self-interact. This is the opposite of the Abraham–Lorentz force in which the radiation damping term \ddot{x} is a pure self-interaction. Despite the absorber theory’s enormous successes, it was eventually rejected on its failure at small length scales. It was acknowledged that there is no good reason why an electron might not emit a photon and then later absorb that same photon. However, early thinking which did not pan out was the foundation for later methods in QED where particle self-interactions are of the utmost importance, *and* where the context for advanced and retarded times survives, as in Section 22. Considering that the absorber theory was supplanted by the Abraham–Lorentz law which is known to have several issues of its own, such as a reliance on a questionable period-averaging procedure, one would reexamine the fundamentals of the absorber model to determine whether or not new MCM physics might bridge the gap where it is said to have failed.

In the opinion of this writer, the *triple-C* cosmic censorship conjecture against the existence of naked singularities has euphemistic overtones referencing censorship in the advanced black hole physics literature. In that vein, one wonders if Feynman truly rejected the absorber theory which had similar interesting things to say about the nature of time. Perhaps censorship in the “national security” apparatus required that he disavow a valid theory? The present problem requires a full reevaluation of the absorber model which nearly worked, but is said to have ultimately failed. Rather than taking the word of those who have looked at it previously, the validity or invalidity of the theory must be independently certified.

24 Renormalization and Regularization

Methods of renormalization and regularization in QFT are pathological to the extent that they could be included in the MCM’s list of targeted issues in quantum theory (Section 1.1.3). Both methods pertain to problematic infinities that arise when computing amplitudes, so both are well suited to reanalysis in the MCM and its fractional distance framework.

To sketch a path of investigation, the method of iterative updates to calculations-on-the-fly called *renormalization* is very much like what we have called translation of the observer’s reference frame onto a higher level of aleph. If we don’t re-normalize to the scale of the higher level of aleph, we expect \hat{M}^3 to output numbers in the neighborhood of infinity that are not useful for comparison to physical quantities observed in \mathcal{H} -branes. Quantum theory will be much improved if unnatural techniques of renormalization are solidified in the context of changing scale from one level of aleph to another. *Regularization* in QFT, on the other hand, is introduced to avoid undefined quantities such as $\infty - \infty$, but such expressions are defined with $\widehat{\infty}$ in fractional distance analysis. Even the regularization cutoff scales imposed by *regulators* might be better implemented when the $\mathbb{R}^{\mathcal{X}}$ local neighborhoods of fractional distance provide inherent, sub-infinite cutoffs. An extensive survey of such methods should be conducted with the intention to regularize or normalize what are currently two irregular and abnormal methods in physics.

Testifying to the pathology of such methods, Dirac is quoted by Kragh as follows [130].

“Most physicists are very satisfied with the situation. They say: ‘Quantum electrodynamics is a good theory and we do not have to worry about it any more.’ I must say that I am very dissatisfied with the situation because

this so-called ‘good theory’ does involve neglecting infinities which appear in its equations, ignoring them in an arbitrary way. This is just not sensible mathematics. Sensible mathematics involves disregarding a quantity when it is small—not neglecting it just because it is infinitely great and you do not want it!”

Similarly, Feynman wrote the following [87].

“The shell game that we play is technically called ‘renormalization’. But no matter how clever the word, it is still what I would call a dippy process! Having to resort to such hocus-pocus has prevented us from proving that the theory of quantum electrodynamics is mathematically self-consistent. It’s surprising that the theory still hasn’t been proved self-consistent one way or the other by now; I suspect that renormalization is not mathematically legitimate.”

25 AdS/CFT Correspondence and Holographic Duality

A key new insight in the MCM is concisely expressed in terms of holographic duality. The solution to electrogravity (Section 18) [7] is a direct application of *holographic* bulk-boundary correspondence. This principle, broadly called AdS/CFT correspondence due to a famous context discovered by Maldacena [59], allows one to describe physics in an N dimensional bulk as a theory on a boundary surface in $N - 1$ dimensions. The AdS/CFT correspondence is specifically such that physics in 5D anti-de Sitter space is determined by a conformal field theory (CFT) whose domain is only the boundary of AdS_5 . The usual program in bulk-boundary correspondence is that the holographic surface is taken as the exterior of one bulk, but the new idea in the MCM is to put the holographic surface between two bulks: 4D \mathcal{H} between 5D Σ^\pm . Therefore, one would make a survey of the primary applications of the extensively treated AdS/CFT problem posed by Maldacena as well as the broader contexts for holographic symmetries in physics. One would attempt to continue the duality of one bulk and one surface to two bulks and a surface, or two bulks and two surfaces (\mathcal{H} and \emptyset) with the goal to make non-trivial advancements in understanding holographic correspondence and its (missing) use cases in physics.

26 Numerical Analysis

Among the 66 theses in this paper, this problem is likely to be the most productive. A multitude of unanswered questions about the exact analytical structure of MCM

mechanisms will be brightly illuminated when the ideas are implemented as an exercise in the numerical analysis of arrays. The analysis of numerical solutions and their visualizations with computer graphics is likely to be more efficient and less cumbersome than a long slog through the analytical underpinning of everything (which will be necessary and delightful.)

A computational environment for simulating physics in the MCM unit cell must be developed. One would begin with numerically integrated wave equations in flat 5D spacetime. One would generalize to 5D wave equations in the $\{-+++ \pm\}$ signatures and study the conditions for their smooth transmissibilities. The array structure of numerical analysis on grids is likely to provide immediate and keen insights regarding what is required for controlling transmission and reflection coefficients at the interfaces between Σ^\pm . One would graduate to simulations of waves in curved space [131, 132]. Having implemented the wave equation in curved spacetime, one would employ optimization to find the $R_{AB}=0$ bulk solutions allowed by KKT. One would explore gravitational waves and scalar EM waves, at least one of which is consistent with a vanishing Ricci tensor. One would make extensions to the heat equation. This long exercise in numerical analysis is likely to answer many open questions regarding the structure of the unit cell and the equation for \hat{M}^3 . The visual representation of simulated time evolutions will be an invaluable aid.

27 The Location of the Observer

The usual space of wavefunctions in the position representation is L^2 , the space of square integrable functions:

$$L^2(\mathbb{R}) \ni \psi : \mathbb{R} \rightarrow \mathbb{C} \quad \Longrightarrow \quad \int_{-\infty}^{\infty} dx |\psi(x)|^2 < \infty \quad . \quad (27.1)$$

The physics of the L^2 condition is that the wavefunction must support the probability interpretation. Being less than infinity, the integral of the absolute square of the wavefunction over all of space can be normalized to unity. This tells us that the probability of finding the particle somewhere in the universe is 100%. The L^2 condition also tells us that the probability of finding the particle at infinity is 0%. Sometimes, the L^2 condition is informally stated as a requirement that $\psi(\infty) = 0$. When one comes across a common phrase in physics, “Assuming boundary terms at infinity go to zero,” this is a reference to the assumed $\psi(\infty) = 0$ condition, as in Section 28. The Cauchy residue theorem is often applied with part of a closed integration path at infinity where the integrand vanishes due to $\psi(\infty) = 0$.

New boundary conditions are always a first thought in the search for new physics, and much of quantum theory is constructed around the $\psi(\infty)=0$ condition. However, there exists one other place where the probability of finding the particle vanishes, one that has been little considered, if at all: the location of the observer. If the observer is located at x_0 , then $\psi(x_0)=0$, but this fact is not reflected in the usual approach to QM. As a matter of practice, the MCM convention is to place the observer at the origin, so one would construct a new state space of wavefunctions which go to zero at infinity *and at the origin*.

In addition to new boundary conditions, new symmetries are also highly regarded in the search for new physics. In fact, symmetries are a type of boundary condition. Using the one point compactification of \mathbb{R} ,¹ namely $\mathbb{R} \cup \{\infty\} = \mathbb{S}^1$, the L^2 condition may be approximated as

$$\psi(x) \in L^2 \quad \Longrightarrow \quad \begin{cases} \psi : \mathbb{S}^1 \setminus \{\infty\} \rightarrow \mathbb{C} \\ \lim_{x \rightarrow \infty} \psi(x) = 0 \quad . \end{cases} \quad (27.2)$$

Calling the proposed subdomain which incorporates the position of the observer L_0^2 , we may write

$$\psi(x) \in L_0^2 \quad \Longrightarrow \quad \begin{cases} \psi : \mathbb{S}^1 \setminus \mathbb{S}^0 \rightarrow \mathbb{C} \\ \lim_{x \rightarrow 0} \psi(x) = 0 \\ \lim_{x \rightarrow \infty} \psi(x) = 0 \quad . \end{cases} \quad (27.3)$$

\mathbb{S}^0 is two points, and we have excluded $x=0$ and $x=\infty$ from the domain of functions in L_0^2 . This represents a radical change in the topological structure of quantum theory, and it may provide powerful new tools for doing quantum mechanics. Furthermore, the Lorentzian structure of spacetime is such that we may treat $\psi(x, t)$ as if it were a function $\psi(z)$ of a single complex variable through $\hat{x} \rightarrow \hat{1}$ and $ic\hat{t} \rightarrow \hat{i}$, as in Sections 1.2.4 and 10. Denoting the Riemann sphere $\mathbb{S}^R = \mathbb{S}^2 \setminus \{\infty\}$, we have

$$\psi(x, t) : \mathbb{S}^R \rightarrow \mathbb{C} \quad \longrightarrow \quad \psi(x, t) : \mathbb{S}^2 \setminus \mathbb{S}^0 \rightarrow \mathbb{C} \quad .^2 \quad (27.4)$$

The removal of the origin from the domain of ψ generates a new topology with more symmetry. The old domain was a sphere missing a point: a famously asymmetric object in analysis. The new domain is the topological difference of two spheres.

¹The one point compactification imposes the circular topology on \mathbb{R} by joining the unjoined endpoints of $(-\infty, \infty)$ with a single infinite element. The two point compactification makes distinctions between $\pm\infty$ so that one obtains the linear interval $[-\infty, \infty]$ without the endpoints being identified.

²The domain of $\psi(x, t)$ is taken as the Riemann sphere $\mathbb{S}^R = \mathbb{C}$ via the $(\hat{1}, \hat{i}) \rightarrow (\hat{x}, ic\hat{t})$ correspondence.

As an example of an application for this new boundary condition, consider the axial current anomaly [133].¹ On qualitative grounds alone, one might suppose that the anomaly in the axial current is associated with a fundamental asymmetry in the underlying domain $\mathbb{S}^R = \mathbb{S}^2 \setminus \{\infty\}$ which ought to be symmetric. To the extent that quantum theory is said to live on the Riemann sphere, the subtraction of a 0-sphere rather than an asymmetric, lone point from \mathbb{S}^2 may have far reaching symmetry implications.

28 Boundary Terms at Infinity

Few phrases are repeated more often in physics than, “Integrating by parts and assuming that boundary terms at infinity go to zero...” As in the previous section, one usually restricts states to L^2 :

$$|\psi\rangle \in L^2 \quad \implies \quad \psi(\infty) = 0 . \quad (28.1)$$

For any

$$\int_{-\infty}^{\infty} u dv = uv \Big|_{-\infty}^{\infty} - \int_{-\infty}^{\infty} v du , \quad (28.2)$$

with u or v in L^2 , we may conclude that $uv|_{-\infty}^{\infty}$ vanishes. Sometimes it is not clear that u or v are in L^2 , however, and we still assume that the boundary vanishes. Furthermore, the integral’s infinite bounds have not been studied in the framework of fractional distance. Thus, ignored boundary terms at infinity are an ideal place to discover new physics and methods for \hat{M}^3 , $\widehat{\infty}$, and the neighborhood of infinity.

Consider the free field Lagrangian

$$\mathcal{L}(\phi) = \frac{1}{2} \left[(\partial\phi)^2 - m^2\phi^2 \right] . \quad (28.3)$$

The generator of the free field theory with source J is

$$Z = \int D\phi e^{i \int d^4x \{ \frac{1}{2} [(\partial\phi)^2 - m^2\phi^2] + J\phi \}} . \quad (28.4)$$

The first term \mathcal{I} in the exponent’s integral is solved with integration by parts. For

$$\mathcal{I} = \int d^4x (\partial\phi)^2 = uv \Big|_{-\infty}^{\infty} - \int v du , \quad (28.5)$$

¹This anomaly may be demonstrated by the construction of an axial current operator from a pair of fields with origins separated by an ϵ which is later put to zero (the Adler–Bell–Jackiw formula [133].) One might explore cases in which the two fields’ origins are located at $\widehat{0}$ and $\widehat{\infty}$, which are later identified.

we take

$$\begin{aligned} u &= \partial\phi & \text{and} & & v &= \phi \\ du &= \partial^2\phi d^4x \ , & & & dv &= \partial\phi d^4x \ , \end{aligned} \quad (28.6)$$

so that

$$\mathcal{I} = \phi \partial\phi \Big|_{-\infty}^{\infty} - \int d^4x \phi \partial^2\phi \ . \quad (28.7)$$

Here, what may be the most-repeated phrase in quantum field theory sets the $\phi \partial\phi|_{-\infty}^{\infty}$ boundary term at infinity to zero due to the L^2 condition. We integrate the non-boundary term and plug the result back into Z to obtain

$$Z = \int D\phi e^{i \int d^4x \{ \frac{1}{2}[-\phi \partial^2\phi - m^2\phi^2] + J\phi \}} = \int D\phi e^{i \int d^4x \{ -\frac{1}{2}[\phi(\partial^2+m^2)\phi] + J\phi \}} \ . \quad (28.8)$$

Since so much of QFT depends on this integral and its permutations, we should very closely examine why we have set the boundary term in \mathcal{I} as an identical zero. Specifically, we should examine whether or not this a ready place to add interactions between unequal levels of aleph, possibly by extending the bounds of integration beyond infinity or restricting the radius of the L^2 condition to the neighborhood of the origin:

$$|\psi\rangle \in \tilde{L}^2 \quad \implies \quad \lim_{x \rightarrow \mathcal{F}_0} \psi(x) = 0 \ . \quad (28.9)$$

Physics requires that the probability amplitude for observing something at infinity is zero, but this neither precludes transfinite bounds of integration nor prevents a restricted \tilde{L}^2 radius. On the latter, the stated physical condition of a realistic potential for being observed is *better* said to require that ψ goes to zero at the end of the neighborhood of the origin. The MCM arithmetic axioms are such that we need only assume that physical fields go to zero at the outskirts of some local neighborhood of fractional distance, but there is no prohibition against them picking up again beyond that, especially when the observer's frame of reference will be transported beyond it in each application of \hat{M}^3 .

The definition of Z in (28.4) is such that d^4x is over all of spacetime, not only a local neighborhood of fractional distance. Therefore, we must make explicit notation such that

$$\int_{\mathbb{R}} dx = \int_{-\infty}^{\infty} dx \quad \longrightarrow \quad \int_{\mathbb{R}^x} dx = \int_{\mathcal{F}_y}^{\mathcal{F}_x} dx \ , \quad (28.10)$$

where \mathcal{F}_y and \mathcal{F}_x are sequential non-arithmetic numbers. An alternative notation

developed for such cases in [2] is such that

$$\int_{\mathbb{R}^{\mathcal{X}}} dx \equiv \int_{\mathbb{R}(n)} dx = \int_{\mathcal{F}(n-1)}^{\mathcal{F}(n)} dx \quad . \quad (28.11)$$

Unfortunately, arithmetic is not defined among non-arithmetic numbers, so

$$\int_{\mathcal{F}(n-1)}^{\mathcal{F}(n)} dx = x \Big|_{\mathcal{F}(n-1)}^{\mathcal{F}(n)} = \mathcal{F}(n) - \mathcal{F}(n-1) = \text{undefined} \quad . \quad (28.12)$$

The likely resolution, as in [2], is that we must treat the non-arithmetic numbers on the n^{th} level of aleph as the natural numbers on the next higher level of aleph. The details of such a physical mechanism would be incorporated into the translation of the observer's frame onto a higher level of aleph (Section 1.6.5), or into a reimagined scheme for renormalization/regularization (Section 24). A mechanism for recasting $\mathcal{F}(n) \in \mathbb{F}$ as the $n \in \mathbb{N}$ on a higher level of aleph is easily conceptualized in the picture of the universe as a one quantum particle. The integral over all of spacetime written as an integral over multidimensional $\mathbb{R}^0 \equiv \mathbb{R}(0)$ bounded by $\mathcal{F}(0)$ on a lower level of aleph will show up as an integral over one unit of volume on the higher level.

In [2], we have shown paradoxes related to the (n) enumeration scheme for the continuous spectrum of \mathcal{X} in $\mathcal{F}_{\mathcal{X}} \in \mathbb{F}$. It is asked what must become of rigor if we are to label sequential elements of a continuum with integers? However, compared to the non-rigor in the infinite-dimensional path integral measure $D\phi$ and the much-loved but non-rigorous

$$\sum \delta t \quad \longrightarrow \quad \int dt \quad , \quad (28.13)$$

method, the slight abuse of (n) notation does not seem great. In each case, the hand-waving regards unallowed intermingling of countable and uncountable infinities. Physicists' affinity for taking such liberties is well contextualized in the non-rigor of writing the $\mathbb{R}^{\mathcal{X}}$ neighborhood as the n^{th} successive neighborhood $\mathbb{R}(n)$. However, further development of the paradoxes detailed in [2] (Section 7 therein) may lead to an enhanced understanding of (28.13), and in the foundations of calculus.

Part III: Problems in Mathematics

29 The Prime Number Theorem

The Riemann hypothesis (RH) is an important question in mathematics because it phrases a deeper question about the distribution of prime numbers. The negation of

RH was demonstrated by new methods for the neighborhood of infinity [2, 47, 48, 79], but the work was not carried through to the prime number application. Therefore, one would extend it to its consequences for prime numbers. Particularly, a well-known formula involving the logarithmic integrals of ρ and $1 - \rho$ looks amenable to plying with fractional distance analysis.

Limited work on the prime counting function $\pi(x)$ which has not been published shows that there are an infinite number of primes less than any number in the neighborhood of infinity. There exists an infinite number of primes in the neighborhood of the origin, so the divergence of the prime counting function evaluated at $x \in \widehat{\mathbb{R}}$ is the correct behavior. This work should be built upon and published. For prime numbers p , numbers of the form $\widehat{\infty} - p$ have the same distribution as the primes. Anything that can be learned about the distribution of $\widehat{\infty} - p$ will necessarily hold for the primes as well. While the distributions are the same, numbers in the neighborhood of infinity have slightly different arithmetic operations [2]. Given these new arithmetic tools, one might find new insights which were inaccessible across more than 150 years of analysis in the neighborhood of the origin. Particularly, the holy grail of number theory is a general algorithm for computing sequences of prime numbers, and this problem deserves attention. Therefore, a review of the prime number theorem and a survey its corollaries are in order.

30 The Riemann ζ Function in Quantum Theory

We have solved RH in [2] and elsewhere [47, 48, 79]. However, we have not gone on to treat the problem which made Riemann’s hypothesis interesting: the prime number problem, as in the previous section. In the modern context for Riemann ζ function (RZF) problems, we have treated neither applications in cryptography nor Hamiltonian operators in quantum theory proportional to ζ . All of this work remains to be done, and the latter is the main topic of this section.

The connection of RH to the prime numbers is well known and concisely stated in many places, but the connection to quantum theory seems more like an intuition shared by a large number of well-respected mathematicians and physicists. A survey of the evidence for an RZF-QFT connection is in order, and particularly a survey of the Hilbert–Pólya operator-based program for tackling RH. Burnol writes the following regarding that program [134].

“*We are convicted*” that the Riemann Hypothesis has a lot to do with (suitably envisioned) Quantum Fields. The belief in a possible link between

the Riemann Hypothesis and Quantum Mechanics seems to be widespread and is a modern formulation of the Hilbert–Pólya operator approach. I believe that techniques and philosophy more organic to Quantum Fields will be most relevant. [T]his point of view has not so far led to success[.]”

If it is thought that studies in quantum theory might shed light on RH, then it is reasonable to expect that a solution to RH would shed light in the other direction. Regarding what can be extracted from the negation of RH in fractional distance analysis for applications in the arena of quantum theory, Borwein, Bradley, and Crandall write the following [135].

“It is intriguing that any of the various new expansions and associated observations relevant to the critical zeros arise from the field of quantum theory, feeding back, as it were, into the study of the Riemann zeta function. But the feedback of which we speak can move in the other direction, as techniques attendant on the Riemann zeta function apply to quantum studies.”

While this writer attended an undergraduate non-linear dynamics course given by Cvitanović, the professor explained that he had become stuck in his research for a long time before discovering that his problem was equivalent to RH. He advised in all seriousness that if any students should ever run into a problem where they find themselves trying to prove the Riemann hypothesis, a change of research direction should be considered. Now that RH is negated, one would search for the application which depended on it.¹ While the exact mechanism by which ζ is connected to quantum chaos is not known to this writer, the following words from Berry and Keating [138], and then Brown [139], suggest that it is worth looking into. If so much association is seen by experts in the field, then it seems likely that the negation of RH would generate fruitful follow-on studies beyond its context in number theory.

“Our purpose is to report on the development of an analogy, in which three areas of mathematics and physics, usually regarded as separate, are intimately connected. The analogy is tentative and tantalizing, but nevertheless fruitful. The three areas are eigenvalue asymptotics in wave (and particularly quantum) physics, dynamical chaos, and prime number theory. At the heart of the analogy is a speculation concerning the zeros of the Riemann zeta function (an infinite sequence of number encoding the

¹Perhaps the application regards a theorem of Connes in non-commutative geometry that is equivalent to RH [136]. Most likely, the application can be found in Cvitanović’s book [137].

primes): the Riemann zeros are related to the eigenvalues (vibration frequencies or quantum energies) of some wave system, underlying which is a dynamical system whose rays or trajectories are chaotic. Identification of this dynamical system would lead directly to a proof of the celebrated Riemann hypothesis. ***We do not know what the system is, but we do know many of its properties*** [*emphasis added*].”

“If you choose a number n and ask how many prime numbers there are less than n it turns out that the answer closely approximates the formula: $n/\log n$. The formula is not exact, though: sometimes it is a little high and sometimes it is a little low. Riemann looked at these deviations and saw that they contained periodicities. Berry likens these to musical harmonics: ‘The question is what are the harmonics in the music of the primes? Amazingly, these harmonics or magic numbers behave exactly like the energy levels in quantum systems that classically would be chaotic.’ This correspondence emerges from statistical correlations between the spacing of the Riemann numbers and the spacing of the energy levels. Berry and his collaborator Jon Keating used them to show how techniques in number theory can be applied to problems in quantum chaos and vice versa. In itself such a connection is very tantalizing. Although sometimes described as the Queen of mathematics, ***number theory is often thought of as pretty useless, so this deep connection with physics is quite astonishing***. [*emphasis added*] Berry is also convinced that there must be a particular chaotic system which when quantised would have energy levels that exactly duplicate the Riemann numbers. ‘Finding this system could be the discovery of the century,’ he says. It would become a model system for describing chaotic systems in the same way that the simple harmonic oscillator is used as a model for all kinds of complicated oscillators. It could play a fundamental role in describing all kinds of chaos. The search for this model system could be the holy grail of chaos... [*We*] cannot be sure of its properties, but Berry believes the system is likely to be rather simple, and expects it to lead to totally new physics. It is a tantalizing thought.”

31 The Hodge Theater and Anabelomorphy

Joshi writes the following [140].

“I coined the term anabelomorphy as a concise way of expressing ‘Mochizuki’s

anabelian way of [*doing things*].”

The purpose of the problem in this section is to identify a 2012 leap in Mochizuki’s program in inter-universal Teichmüller theory (IUT) [141–144] as a rebranding of the MCM. The unit cell was not published until 2013, but the nine year process of revision leading to Mochizuki’s journal publication of [141–144] in 2021 may have incorporated later MCM work. To begin, one notes that the first figure in the first IUT paper [141] (Figure 24) is quite like the 2009 time-wrapped-around-a-cylinder idea for MCM time periodicity [31]. (This was later supplanted by periodicity in unit cell [7].)

We will phrase the main criticism of Scholze and Styx (SS) against Mochizuki’s claimed proof of the ABC conjecture [145] as pertaining to a fundamental concept in the unit cell. Paraphrasing, SS [145] have refused to acknowledge that Mochizuki has proven ABC because he takes isomorphic objects as unequal. To the extent that Mochizuki’s “Hodge Theater” is only the MCM unit cell dressed in inaccessible jargon, we will motivate the existence of two isomorphic objects which are not the same object in the sense of abstract algebra. Although the domain of the wavefunctions $\psi(x^i)$ in each \mathcal{H}'_n is just a Euclidean 3-space E^3 , each E^3 is the spacelike slice of Minkowski space at a given x^0 . Therefore, although all infinite Euclidean 3-spaces are isomorphic copies of E^3 , we may distinguish among them by labeling them with the affine parameter x^0 so they are unequal. In other words,

$$k \neq j \implies \mathcal{H}_k \neq \mathcal{H}_j . \tag{31.1}$$

It seems likely that this can be parlayed into a rebuttal of SS’ criticism if Mochizuki has utilized the MCM without introducing errors.

Joshi describes similtude to the MCM in [140].

“One could think of anabelomorphy in the following picturesque way: One has two parallel universes (in the sense of physics) of geometry/arithmetic over p-adic fields K and L respectively. If K, L are anabelomorphic (i.e. $K \neq L$) then there is a worm-hole or a conduit through which one can funnel arithmetic/geometric information in the K -universe to the L -universe through the choice of an isomorphism of Galois groups $GK \simeq GL$, which serves as a wormhole. Information is transferred by means of amorphic quantities, properties and alg. structures. The K and L universes themselves follow different laws (of algebra) as addition has different meaning in the two anabelomorphic fields K, L (in general.) As one might expect, some information appears unscathed on the other side, while some is altered

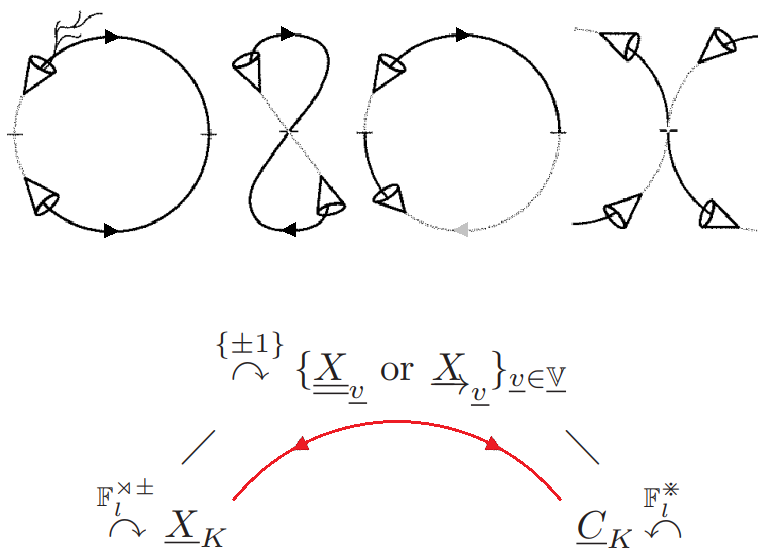

Figure 24: The upper MCM figure adapted from [31, 40] derives correspondence between cosmological bouncing and particle scattering by wrapping the time axis of Minkowski space around a cylinder and then imposing smooth deformations. Horizontal hashes mark big bounces. The lower algebraic diagram from [141] (red curve added) contextualizes Mochizuki’s work in the 2009-2012 period when MCM time periodicity was obtained by imposing cylindrical topology. It is suggested that Mochizuki has condensed the possibilities for various inter-bounce modules (above) into a single algebraic diagram (below).

by its passage through the wormhole. Readers will find ample evidence of this information funneling throughout this paper (and also in [*Mochizuki’s papers*] which lay the foundations to it.)

“I hope that these results will convince the readers that Mochizuki’s idea of anabelomorphy is a useful new tool in number theory with many potential applications (one of which is Mochizuki’s work on the abc-conjecture.) Especially it should be clear to the readers, after reading this paper, that assimilation of this idea (and the idea of anabelomorphic connectivity) into the theory of Galois representations should have interesting consequences for number theory. Here I have considered anabelomorphy for number fields but interpolating between the number field case and my observation that perfectoid algebraic geometry is a form of anabelomorphy, it seems reasonable to imagine that anabelomorphy of higher dimensional fields will have applications to higher dimensional algebraic geometry as well.”

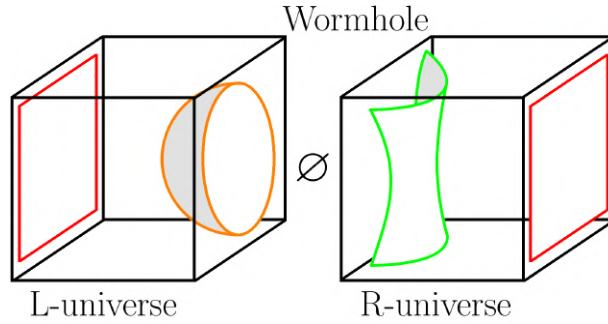

Figure 25: This figure casts the description of anabelomorphy given by Joshi in [140] (Section 1.7 therein) in terms of the unit cell.

Here, the reader’s attention is called to what Joshi hopes will “be clear to readers.” It is suggested that the “ample evidence” cited by Joshi is evidence of the foundations of Mochizuki’s later work in the MCM. The language of L - and K -universes due to Joshi [140] signifies the left and right Σ^\pm universes under a clever change of notation $R \rightarrow K$, as in Figure 25. Although the citations were removed in the above excerpt, Joshi cites 2013 and 2015 works of Mochizuki in addition to the four principle papers from 2012 [141–144]. It must be determined if Joshi’s L, K notation references something Mochizuki had done before the 2013 publication of the non-cylindrical unit cell in 2013 [7].

Clarifications made by Mochizuki following a series of IUT-related discussions in 2018 seem to reflect MCM developments in the intervening years which were not contained in the 2012 papers themselves. Mochizuki writes the following in [146]. (The formatting is altered, and most citations are removed.)

“Another topic to which a substantial amount of time and energy was devoted, especially during the first few days of the March discussions, was the topic of labels to distinguish distinct copies of various familiar objects that play substantively different roles in the various apparatuses treated in IUTch. SS (especially, Scholze) were substantially opposed to the use of labels in IUTch. This opposition appeared to be based, to a substantial extent, on ‘taste/aesthetics.’ In this context, however, it should be remembered that in fact ‘labels’ [are], in effect, situations in which one wishes to distinguish distinct copies of various familiar objects that play substantively different roles within a complicated apparatus. [...]

“In light of the general considerations concerning the use of labels [...], it is of interest to review the way in which labels for distinct copies of various

familiar objects are employed in IUTch in order to construct apparatuses that play various substantive roles in IUTch that cannot be achieved if the labels are deleted. One fundamental example of this phenomenon is the bookkeeping apparatus for labels for evaluation points within a single Hodge theater.

“This phenomenon is discussed in detail in [141], §I1 (and indeed throughout [141]!). On the other hand, such labels within a single Hodge theater were only mentioned very briefly during the March discussions. The ‘label issues’ that were discussed in substantial detail during the March discussions concern the labels [...] that correspond to the [*Hodge theaters*] in the log-theta-lattice. Here, we begin our discussion of these labels by recalling the (highly noncommutative!) diagram that is used to denote the entire log-theta-lattice [...], together with the portion of the log-theta-lattice [...] which consists of the vertical arrows in the 0- and 1-columns, together with the single horizontal arrow between the [*Hodge theaters*].

“[*A Hodge Theater is*] a single model of the conventional ring/scheme theory surrounding the elliptic curve over a number field under consideration. One then considers two types of gluing (denoted by the vertical and horizontal arrows in the diagrams) between certain portions of the Hodge theaters in the domain and codomain of each arrow. The vertical arrows denote log-links, while the horizontal arrows denote θ -links.”

If the Hodge theater is the unit cell, the evaluation points are certainly the labeled branes. The multiple “vertical arrows” seem to refer to the $\{x_+^0, x^0, x_-^0\}$ chronological times in the labeled branes while the “single horizontal arrow” must refer to χ^4 . It should be investigated to what extent such language may have appeared in Mochizuki’s 2012 papers pre-dating the unit cell, and to what extent these arrows might have referred to the MCM’s arrow-laden unit cell precursors [31, 40]. It is likely that Mochizuki’s context for elliptic curves is derived from the 2011 \hat{M}^3 operator which we have used to arrive at elliptic curves presently in Section 1.11.5. Therefore, we have laid the foundation for a large work unit sifting through a thousand or more pages of Mochizuki’s notoriously inaccessible jargon and unfortunate typographical choices. One would attempt to *see what he did there* and scan for any new insights that may have been included in the voluminous obfuscating layers. Such insights may or may not exist, which is to say that Mochizuki may have taken this writer’s idea and not added anything before rebranding it at his own idea.

32 Regularity Structures

“Martin Hairer takes \$3m Breakthrough prize for work a colleague said must have been done by aliens.” [55]

After Hairer won the Fields Medal in 2014, Quastel said his work in regularity structures must have been done by aliens because he knows very well that a “regularity structure” is the MCM unit cell equipped with the \hat{M}^3 operator. Consider Hairer’s words in [54].

“The purpose of this article is to develop a general theory allowing to formulate, solve and analyse solutions to semilinear stochastic partial differential equations of the type

$$\mathcal{L}u = F(u, \xi) \quad , \quad (32.1)$$

where \mathcal{L} is a (typically parabolic but possibly elliptic) differential operator, ξ is a (typically very irregular) random input, and F is some nonlinearity.”

Hairer describes the general problem of \hat{M}^3 which was the topic of Section 1. He uses \mathcal{L} as \hat{M}^3 and condenses everything we don’t know about the physics of the unit cell into F . Hairer continues as follows [54].

“One major difference between the results presented in this article and most of the literature on quantum field theory is that the approach explored here is truly non-perturbative and therefore allows one to deal also with some non-polynomial equations [...]. We furthermore consider parabolic problems, where we need to deal with the problem of initial conditions and local (rather than global) solutions. Nevertheless, the mathematical analysis of QFT was one of the main inspirations in the development of the techniques and notations presented [*elsewhere in [54]*].

“Conceptually, the approach developed in this article for formulating and solving problems of the type [(32.1)] consists of **three steps** [*emphasis added*].

1. In an algebraic step, one first builds a ‘regularity structure’, which is sufficiently rich to be able to describe the fixed point problem associated to [(32.1)] Essentially, a regularity structure is a vector space that allows to describe the coefficients in a kind of ‘Taylor expansion’ of the solution around any point in space-time. The twist is that the

‘model’ for the Taylor expansion does not only consist of polynomials, but can in general contain other functions and/or distributions built from multilinear expressions involving ξ .

2. In an analytical step, one solves the fixed point problem formulated in the algebraic step. This allows to build an ‘abstract’ solution map to [(32.1)]. In a way, this is a closure procedure: the abstract solution map essentially describes all ‘reasonable’ limits that can be obtained when solving [(32.1)] for sequences of regular driving noises that converge to something very rough.
3. In a final probabilistic step, one builds a ‘model’ corresponding to the Gaussian process ξ we are really interested in. In this step, one typically has to choose a renormalisation procedure allowing to make sense of finitely many products of distributions that have no classical meaning. Although there is some freedom involved, there usually is a canonical model, which is ‘almost unique’ in the sense that it is naturally parametrized by elements in some finite-dimensional Lie group, which has an interpretation as a ‘renormalisation group’ for [(32.1)].

“We will see that there is a very general theory that allows to build a ‘black box’, which performs the first two steps for a very large class of stochastic PDEs. For the last step, we do not have a completely general theory at the moment, but we have a general methodology, as well as a general toolbox, which seem to be very useful in practice.”

Step one regards the construction of the unit cell. In step two, Hairer defines the metric and 4-potential in \mathcal{H} from “reasonable” limits in Σ^\pm . Step three is the main problem which remains open in the MCM: how to push Schrödinger evolution from the \mathcal{H} -brane, through \emptyset , and then into the forward \mathcal{H} -brane in a way that agrees with experiment? Consider this writer’s words from [30].

“There are varying philosophies on quantum experimentation so let us define a process thoroughly. Two measurements must be made, A and B . The boundary condition set by A will be used to predict the state at B . The observer applies physical theory to trace a trajectory [*from A*] into the future and [*to*] predict what the state will be at that time. Before the observer can verify the theory, sufficient time must pass that the future event occurs. Once this happens a signal from the event reaches the observer in the present and a second measurement B becomes possible. From the

present we predict into the future. In time that becomes the past. When the signal from that event reaches the observer a theory can be tested. A three-fold process.

$$\text{Present} \mapsto \text{Future} \mapsto \text{Past} \mapsto \text{Present} \text{ .} \tag{32.2}$$

The Fields Medal and \$3M award suggest that Hairer has sufficiently developed the mathematical foundations of the issues raised in Section 1 to the point where serious things can be said about their resolutions.¹ Therefore, one would conduct of survey of Hairer’s main results regarding “regularity structures.” New insights achieved by Hairer, if any are found, may be useful for pushing the MCM past certain conceptual hurdles.

The reader is encouraged to carefully note that Hairer’s 2013 publication date for [54] comes chronologically later in the literature than the first iterations of \hat{M}^3 and the unit cell [3, 7, 30, 40]. Indeed, Hairer’s March 2013 publication date following so closely after the unit cell was published in January 2013 [7] is *oddly* timed with Ellis’ and You’s fallacious exaggeration regarding reasonable doubt in March 2013 [28]. One might entertain the notion that Ellis, You, Hairer, and others were working as agents of a conspiracy to besmirch and naysay the MCM while plagiarizing it. If such a conspiracy exists, as is suggested in Appendix C, it is unlikely that this writer has uncovered all of its evidence in the literature. However, it remains that Hairer’s work has at least the appearance of being well received in the mathematical community, and one would survey the work looking for new insights that might have applications in the MCM. Such insights may or may not exist. Hairer may have taken this writer’s idea and not added anything at all before rebranding it at his own idea.

33 Quantum Set Algebra

Finkelstein’s final seven uploads to arXiv all appear to be MCM response papers [147–153]. The last two are mathematical in nature and support this problem’s placement in Part III, in part. Before making a brief summary of the points of interest in Finkelstein’s arXiv publications, including his work on quantum set algebra, we will make a contextual aside regarding the MCM’s *administrative* peer review status.

Finkelstein had already moved into professor emeritus status when this writer began PhD studies at Georgia Tech. This was unfortunate because Finkelstein’s

¹Another reasonable conclusion to draw from Hairer’s \$3M award is that the main purpose of the Breakthrough Prize created by Milner, an Israeli, is to elevate the position of those who have an interest in the scientific demise of this writer. Perhaps similar things can be said about the Fields Medal committee.

research area overlaps with this writer’s interests. After [31] was censored by the arXiv moderators in 2009, and after [40] was similarly forbidden in 2011, this writer reached out to the faculty in the School of Physics and was put in contact with Finkelstein. After a few brief conversations, Finkelstein assured this writer that a fair hearing of peer review could be had IJTPD. At that time, it was not known to this writer that Finkelstein was an editor at IJTP from 1977 to 2005. In hindsight, the “fair hearing” was only that Finkelstein would don his anonymous reviewer’s mask to unleash all the criticisms he had withheld in conversations meant only to milk this writer’s ideas without offering his own constructive inputs. After submitting a manuscript regarding the MCM and the theory of reverse time,¹ the reviewer quickly denied publication. The brief rejection letter is accurately paraphrased as, “The author doesn’t know the ADM theorem² from a hole in the ground.” It is assumed that the reviewer was Finkelstein, and it is certain that a fair hearing was not had.

A rebutting response to the editor cited an assumption of cosmological isotropy and homogeneity in the Arnowitt–Deser–Misner (ADM) model of the universe as a non-orientable manifold. This assumption is called the cosmological principle. From that assumption, ADM extract the differential element of surface area at spacelike infinity and use that as the centerpiece of their theorem [41]. However, modern data which was only published near the end of Finkelstein’s long career shows that the cosmological principle is not sound. Correlations in the structure of the CMB are not consistent with the isotropy used by ADM. The quadrupole and octupole moments seen in CMB fluctuations are aligned when they have no reason to be. Both moments are further aligned with the plane of the solar system along what is called an *axis of evil* in modern cosmologies where the universe very much has an inherent orientation [154]. On the other hand, the two-universe structure cited in the manuscript submitted to IJTPD [40] was consistent with a symplectic 2-form at spacelike infinity from which either positive- or negative-definiteness of the universe’s p^0 would follow (Section 44). This directly and cleanly refuted the reviewer’s (Finkelstein’s) criticism about the ADM theorem preventing a negative energy universe moving backward in time from a cosmogenesis event.

If a fair hearing would have been had at IJTPD, the point in the rebuttal would have been acknowledged, but it was ignored, and the manuscript was removed from the online submission system about two weeks later. The true events were that the ideas in the MCM blew away anything Finkelstein had done in his career with respect

¹The manuscript submitted to IJTPD was a version of [40].

²This theorem proving the positive-definiteness of the p^0 component of the universe’s 4-momentum was said to disallow another universe with $p^0 < 0$. A rebuttal to this claim appears in Section 44.

to original thinking.¹ When his attempt to pontificate and detract from behind an anonymous reviewer's mask was destroyed on its merits due to new data which he had not appreciated, or whose consequences for the ADM theorem he had not evaluated, he retreated into a fog of anonymity to remove the manuscript from consideration. He did not acknowledge that new data is inconsistent with the cosmological principle which was in vogue across the several decades of his professional life. The entire encounter with Finkelstein, in person and anonymously, reeks of egotism and academic treachery. Although citations in the remainder of this section will demonstrate that Finkelstein had already written at least two MCM response papers before meeting with this writer in 2011 [147, 148], he pretended to gross ignorance in our conversations. Furthermore, he withheld his criticism about the ADM theorem during our meetings. This writer had never heard of the ADM theorem before the critique at IJTPD, but the wrongful reliance on the cosmological principle was identified in less than hour once the reviewer's citation was received, as was the workaround described in Section 44. Had Finkelstein mentioned the ADM theorem in person, it would have been impossible for him to ignore the rebuttal. However, he shrewdly (maliciously) withheld his criticism until it would be possible to ignore rebuttals and avoid any forced admission of wrongness from the safety of a zero-accountability environment.

Hitler writes the following [156].

“The more I debated with them the more familiar I became with their argumentative tactics. At the outset they counted upon the stupidity of their opponents, but when they got so entangled that they could not find a way out they played the trick of acting as innocent simpletons. Should they fail, in spite of their tricks of logic, they acted as if they could not understand the counter arguments and bolted away to another field of discussion. They would lay down truisms and platitudes; and, if you accepted these, then they were applied to other problems and matters of an essentially different nature from the original theme. If you faced them with this point they would escape again, and you could not bring them to make any precise statement. Whenever one tried to get a firm grip on any of these apostles one's hand grasped only jelly and slime which slipped through the fingers and combined again into a solid mass a moment afterwards. If your adversary felt forced to give in to your argument, on account of the observers present, and if you

¹Eddington–Finkelstein coordinates are due to Penrose [155] and ought to be called Penrose coordinates because neither Eddington nor Finkelstein ever wrote them down. They came to be named as they are because Penrose, when he was receiving accolades for his coordinates, cited much older papers written by Eddington and Finkelstein as providing the *ideation* for his own paper [155]. Therefore, it is the height of irony that Finkelstein's claim to fame is based on an acknowledgment of progenitive ideation of the sort Finkelstein himself has been so keen to avoid.

then thought that at last you had gained ground, a surprise was in store for you on the following day. The Jew would be utterly oblivious to what had happened the day before, and he would start once again by repeating his former absurdities, as if nothing had happened. Should you become indignant and remind him of yesterday’s defeat, he pretended astonishment and could not remember anything, except that on the previous day he had proved that his statements were correct. Sometimes I was dumbfounded. I do not know what amazed me the more—the abundance of their verbiage or the artful way in which they dressed up their falsehoods. I gradually came to hate them.”

Finkelstein never admitted to this writer that he was the reviewer at IJTPD, but perhaps he gained mastery in such tactics of evasiveness and deceit during his time at the Hebrew University and Yeshiva University. The reviewer simply laid down a platitude regarding the ADM theorem before slipping away without being forced to concede the cosmological principle’s unsound footing in modern experiments or the implied possibility for a symplectic 2-form at spacelike infinity. Indeed, Finkelstein employed such cunning that he was not forced even to concede awareness of the existence of the rebuttal. The reviewer at IJTPD wrote his criticism sounding as if he knew what he was talking about, but he did not. Instead, he counted on the stupidity of his critique’s readers to be such that the contents of the ADM paper [41] would not be verified. When this writer’s rebuttal was submitted in short order, the reviewer bolted away and used his authority to remove the manuscript from consideration. Furthermore, the reviewer’s implication that the ADM theorem should take precedence over *the law of conservation of momentum* was profoundly stupid.

The following appears in Finkelstein’s [147]. Published in 2010, we suggest [147] is a response to an MCM paper published in 2009 [31].

“The proposed quantum theory, termed recursive, represents the system as a recursive quantum assembly. Its modules have Fermi-Dirac statistics, and are modularizations, or unitizations, of like assemblies of a lower level, or rank. Each assembly is also interpreted as a quantum topological simplex with its constituent modules as its vertices.”

It is suggested that Finkelstein refers to Figure 26 which first appeared in [31]. The quantum theory is recursive due to its placement in the context of Ashtekar’s model of loop quantum cosmology. The modules are said to have Fermi–Dirac statistics because the particles in the Feynman diagram of Figure 26 obey such statistics. So,

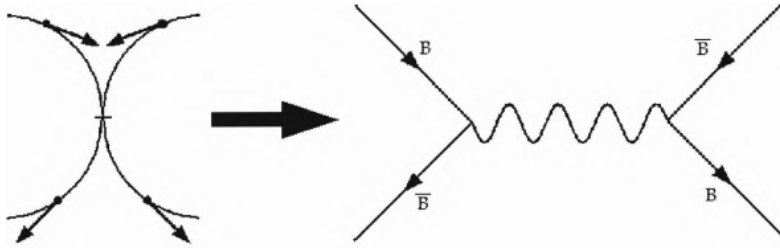

Figure 26: In this figure taken from [31], time increases toward the right (negative time increases toward the left). On the left, a spacetime diagram has been deformed so as to impose a periodic boundary condition along the x^0 axis. The same diagram of another universe whose time arrow points oppositely intersects the former at a big bounce. It was suggested that the familiar Feynman diagram for electron-positron scattering might offer a ready framework for describing the cosmological mechanics of such a bounce complex. A further implication derived by replacing the spacetime picture with a particle picture is that we may associate the anomalous, non-zero, positive baryon number B of the universe with the $+1$ lepton number of an electron, and likewise for the anti-universe and positron.

although Finkelstein found non-compliance with the ADM theorem to be an unfixable problem when he was hiding behind an anonymizing bureaucracy in 2011, the man himself saw enough merit in the MCM to take it as his own without citation in 2010. At the end of the abstract to [147], Finkelstein writes, “The gauge structure, the spin-statistics correlation, the space-time metric, and the Higgs field are modeled.” This an apparent reference to the final sentence of the abstract in [31]: “No attempt at quantification is made.” Since Finkelstein claims to have moved forward with quantification, his results must be surveyed. If they are found to be useful, they should be incorporated into future work.

In [148] (August 2011), Finkelstein writes the following.

“Present-day quantum field theory can be regularized by a decomposition into quantum simplices. This replaces the infinite-dimensional Hilbert space by a high-dimensional spinor space and singular canonical Lie groups by regular spin groups. It radically changes the uncertainty principle for small distances. Gaugeons, including the gravitational, are represented as bound fermion-pairs, and space-time curvature as a singular organized limit of quantum non-commutativity.”

The uncertainty principle is said be changed at small distances because Finkelstein is making an appeal to Ashtekar’s “repulsive force of quantum geometry.” By this

so-called force, Ashtekar has claimed that topological singularities are avoided during big bounce events. Instead of absolutely divergent collapse, the repulsive force of quantum geometry somehow kicks in at very small length scales so as to avoid the formation of a pointlike singularity. It is now this writer's opinion that the repulsive force of quantum geometry is nothing more than an artifact of Ashtekar's numerical algorithms, and Finkelstein was bluffing to suggest that he understood a new method in "present-day QFT." However, Finkelstein further claims to represent gaugeons (bosons) as bound fermion pairs which may be useful for associating the baryon number of a universe in a spacetime diagram with the lepton number of a fermion in a Feynman diagram. Certainly, Finkelstein's remark pertains to Figure 26. Perhaps his faith in the ADM theorem led him to discount the existence of a reversed universe so that fermion pairs on both sides of an annihilation event were associated with one universe on either side of a bounce. Perhaps the fermion pairs were an ingoing particle and an outgoing one corresponding to a universe going into the bounce and coming out of it, and Finkelstein fully copied the dual universe structure in 2010 before disputing it on the basis of the ADM theorem in 2011.

After meeting with this writer following a second event of censorship at arXiv in 2011, and before a third similar event at IJTPD, Finkelstein left Atlanta for a period of weeks claiming to have traveled to a certain castle in Bulgaria. Upon returning, he published [149–151] on arXiv in quick succession. These must be considered response papers to [30,40] (November 2011). One wonders if Finkelstein used a so-called retreat in Bulgaria as cover for travel to Israel where he would more closely collaborate with others among this writer's most detractive antagonists.

The first statement of the three-fold process for \hat{M}^3 appeared in [30]: observation, prediction, waiting, and observation again. Finkelstein writes the following in [149] which followed [30,40] by about two months.

“Call the process, if any, by which natural laws are formed ‘logogenesis’. Josephson proposed that quantum observer-participation leads to logogenesis. [...] In the logogenesis proposed by Peirce, nature first acts by chance, then acts form habits, and finally habits harden into more permanent laws. The formation and hardening of habits are not further described by Peirce. I speculate next on a still unformulated quantum logogenesis with elements of those of Einstein and Peirce. Peirce's ‘habit-forming tendency of nature’ can be read as a remarkable premonition of Bose statistics. In each step in time, the system is first annihilated and then recreated. This was asserted by Islamic Scholastics of 10th century Baghdad and is explicit

in quantum field theory, where a creation ψ^* follows every annihilation ψ in the action principle for a particle.

Finkelstein has dubbed the process for \hat{M}^3 a process of “logogenesis.” He refers to a system of logogenesis based on observations, exactly like \hat{M}^3 . Later in [149], he writes, “Peirce’s signs occur in a semantic triangle of sign, interpretant, and object.” This seems to be an attempt to attribute ideation for his own *forthcoming* three-fold process of logogenesis to work other than what is found in [30]. Keeping in mind that the unit cell was not yet devised in 2012, the three steps of \hat{M}^3 were $t_0 \rightarrow t_{\max} \rightarrow t_{\min} \rightarrow t_0$, and they are referenced by Finkelstein’s inclusion of creation and annihilation in each step of logogenesis. The universe falls into a big crunch at t_{\max} , and then it is reborn in a big bang at t_{\min} .

Finkelstein writes the following in [150].

“A finite relativistic quantum space-time is constructed. Its unit cell has Palev statistics defined by a spin representation of an orthogonal group. When the Standard Model and general relativity are physically regularized by such space-time quantization, their gauges are fixed by nature; the cell groups remain.”

Fixation of the gauge by nature is a clear reference to the FSC result in [30]. The finite quantum spacetime follows the MCM program of modular spacetimes [40] and references the 2D box used in the original derivation of α_{MCM} [30]. When meeting with this writer upon his return from “Bulgaria,” Finkelstein was exceedingly insistent that Palev statistics [150] were what the MCM was lacking. Therefore, Palev statistics should be taken with a grain of salt, and deliberate misinformation should be considered. Finkelstein’s character suggests that he would offer bad advice as a complement to the constructive criticism he withheld while feigning *total unfamiliarity* with the MCM in late 2011. However, Finkelstein’s insistence on writing his own variant of the MCM in the language of statistics throughout [147–153] can probably be trusted as the best intuition of a man who spent his life searching for a better theory. Palev statistics should be examined on its merits, and a statistical treatment of the MCM should be developed regardless of the utility or non-utility of such statistics.

Finkelstein’s citation of “di-fermions” as “Palevons” [150] suggests that he was at least as enamored of the mechanism in Figure 26 as was this writer. Di-fermions are the representation of the pre- and post-bounce states given bosonic baryon numbers as pairs of fermions. The high esteem of Finkelstein should further undermine detractors’



Figure 27: This figure excerpted from [151] shows the three steps of \hat{M}^3 .

insistence that the correspondence, or *duality*, between the spacetime and particle pictures (Figure 26) was vague, meaningless, and/or other unscholarly things.

Finkelstein writes the following in [151].

“I once asked Jack Schwartz what the difference was between mathematics and physics. At the time both were just equation-juggling to me. He was strap-hanging homeward from Stuyvesant High School, where we had just met, and he answered by drawing a hat in the subway air with his free hand: [Figure 27.] He explained that the bottom line is the real world and the top line is a mathematical theory. At its left-hand edge we take data from the real world and put them into a mathematical computation, and at the right-hand side we compare the output of the computation with nature. The loop closes if the theory is right. This diagram also applies to quantum systems, if the statistical nature of quantum theory is taken into account. Then the bottom line is not one experiment on the system but a statistical population of them. The question remains of what the symbols of mathematics mean to a mathematician. Some decades later I asked Jack Schwartz what ‘1’ means, and he replied that it means itself. This took me aback. I had not considered that possibility. Symbols generally mean something not themselves. Memorandum:

$$1 = \text{‘1’ .} \tag{33.1}$$

By the conspicuous absence of the present writer’s name in the gratitude section at the end of [150], perhaps Finkelstein would have his readers believe that without seeing [30, 31, 40], he spontaneously decided to write a paper [151] about how his old friend Jacky Boy from back in the day had explained to him 70 years ago that any mathematical description of a physical process is constrained to follow \hat{M}^3 . Perhaps the Jackster never told him any such thing, and this lie was part of a ruse designed to avoid recognizing the keen insights had by this writer.

After the unit cell [7] and MCM particle scheme [6] were published in 2013, Finkel-

stein produced two final uploads to arXiv regarding “quantum set algebra” [152,153]. The following are excerpted from [152].

“Quantum field theory can be physically regularized by modularizing it on several levels of aggregation. [...] Relativistic locality makes each point of a spacelike surface a separate physical system, in that the variables it carries are independent of those of any other point of the surface. Therefore a relativistic theory is necessarily a many-system theory. In a quantum theory this implies an algebra of creation and annihilation operators, not a mere vector space. The Hilbert space theory is a one system theory. Its constructs correspond to those of classical predicate algebra, with no analysis into independent systems.”

“In the Standard Model or any other quantum field theory [...], an experiment is a network of operations of quantum creation and annihilation, or input and output. For brevity, call these *port operations*, portations, or most briefly ports, and say that they *import* or *export* quanta. [...] Boole’s Laws of Thought and the set theory of Cantor, in which ‘A set is a Many that allows itself to be thought of as a One,’ explicitly concern mental processes. Adapted to quantum physical processes, the Laws of Thought of Boole become Laws of Ports and the set of Cantor becomes a Many that can be ported as One.”

The modularized, many-system theory refers to the 2013 brane structure of the unit cell [7]. Finkelstein seems to have associated the chirological interval separating branes with a spacetime diagram’s spacelike interval. Alongside the first statement of the unit cell, a brief note restating the rebuttal to Finkelstein’s criticism regarding the ADM theorem appeared in [7]. Finkelstein may have associated a possible symplectic 2-form at spacelike infinity with a doorway or “port” out of \mathcal{H} , into the chirological interval. References to “the Laws of Thought” and “mental processes” allude to the MCM process for \hat{M}^3 being psychological in nature.

Finkelstein writes the following in [153].

“A modular quantum architecture is given for the space-time, particles, and fields of the Standard Model and General Relativity. It assumes a right-handed neutrino[.]”

Finkelstein alludes to the 2013 MCM particle scheme [6] following from the architecture of the unit cell. The reference to handedness invokes the distinction be-

tween left- and right-handed spacetime quanta distinguishing quark and lepton pairs. Finkelstein also writes the following [153].

“Because the Heisenberg indeterminacy principle is so weakened, it can no longer be excluded that gaugeons are pairs of odd quanta, though these odd quanta are not necessarily the ones able to exist as free quanta.”

The MCM particle scheme is such that the gauge bosons are formed from pairs of “odd quanta,” or fermions. Finkelstein does not cite the MCM particle scheme. Instead, he cites some vague weakening of the Heisenberg indeterminacy principle. Indeed, Finkelstein had already suggested such a construction in 2011 [148], based on Figure 26 apparently, without the benefit of the explicit model of bosons as pairs of fermions given in [6].¹

Overall, the dating of the main body of citations in [147–153] suggest that Finkelstein stopped learning new things at some point in the 1970s. The prose in the papers is abrupt if not broken, and the jargon is idiosyncratic or anachronistic to the point of being non-standard (which is ok.) However, since these papers represent an honest attempt to steal the MCM, the work should be dissected, and any original contributions due to Finkelstein should be utilized in future work, if any are found to exist at all.

34 The Navier–Stokes Equation

The Navier–Stokes problem posed by the Clay Mathematics Institute asks if there exist “physically reasonable” solutions to the Navier–Stokes equation [157]. Often one solves complicated differential equations with combinations of exponential functions, so the utility of fractional distance analysis towards new zeros for e^x must be evaluated in the context of this problem. In the neighborhood of the origin, e^x has no roots on the real line. In the neighborhood of infinity, e^x has an infinite number of roots. This behavior should allow a rich new class of solutions for differential equations. The big exponential function E^x [2] offers another tool which may be useful for finding new solutions to differential equations. As the Riemann hypothesis was immediately solved with fractional distance analysis (almost trivially [2, 47, 48]), the similar mathematical structure of the Navier–Stokes problem demanding nothing more than a solution to an equation suggests that this problem might be solved in another forthright manner.

¹This writer had not yet begun to review Finkelstein’s publications when the MCM model of particles was constructed in [6].

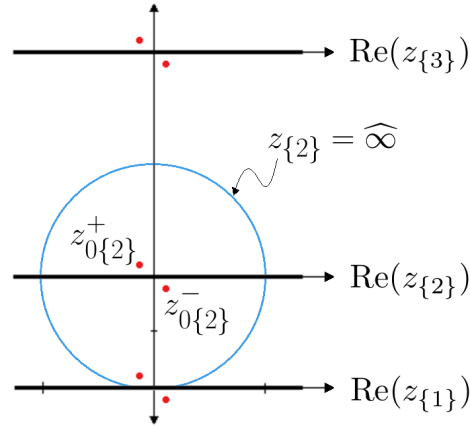

Figure 28: This figure, adapted from [72], shows a proposal for a proof of the existence of the Yang–Mills mass gap. The red dots are the poles of the k_0 part of the free propagator on a given level of aleph. Horizontal lines show the real axis of \mathbb{C} on the $\{k\}$ level of aleph. Such instances of \mathbb{C} are joined by mutual transverse continuations onto \mathbb{C}_{\pm}^* . The blue circle is the radius at infinity relative to the origin of $\mathbb{C}_{\{2\}}$. The radius at infinity increases as $\{k\}$ increases. The mass gap is attributed to the enclosure of three poles within that radius where only two are usually considered.

35 The Yang–Mills Mass Gap

The Millennium Prize regarding Yang–Mills theory [158, 159] requires proof that a quantum Yang–Mills theory exists in four dimensions, and that it contains the mass gap $\Delta > 0$ required by QCD. An MCM solution to this problem was proposed in [72]. Briefly, a transfinite continuation of the complex plane was introduced and associated with the changing level of aleph attendant to \hat{M}^3 , as in Figure 28. (We will call this continuation \mathbb{C}^* though its context in [72] was not exactly as described in Section 1.2.4.) In Figure 28, $z_{\{k\}}$ is the complex variable on the k^{th} level of aleph. The origin of each $z_{\{k\}} \in \mathbb{C}_{\{k\}}$ is found where the real axis crosses the vertical axis. Using QED as a jumping off point for this more challenging problem in QCD, one often examines the free propagator $D(x - y)$ from which we integrate out the time part $D^0(x - y)$. The two poles of $D^0(x - y)$ are the pairs of red dots shown in Figure 28: $z_{0\{k\}}^{\pm}$ on the k^{th} level of aleph such that

$$z_{0\{k\}}^{\pm} \equiv z_0^{\pm} \in \mathbb{C}_{\{k\}} \quad . \quad (35.1)$$

Although we have taken a transfinite extension of \mathbb{C} , we preserve the notion of an integration path at infinity. (The blue circle is the path at infinity relative to the

$k=2$ level of aleph. The radius of the path at infinity increases as the level of aleph increases.) To simplify $D^0(x - y)$, one usually employs the Cauchy residue theorem, integrates along the real axis, and closes the Cauchy C curve with a path at infinity in the upper or lower complex half plane. Depending on the path, one pole or the other is enclosed, the integral at infinity vanishes, and the integral along the real axis is left to equal to $2\pi i$ times the enclosed residue.

The idea for generating a mass gap is found with the third pole near the origin of $\mathbb{C}_{\{k-1\}}$. This pole is included within the path at infinity in \mathbb{C}^* , but it does not exist in \mathbb{C} . Appealing to the more complicated structure of QCD requiring such features as quark confinement which have no analogues in QED, one might take the function in the Cauchy theorem to be a sum of propagators on the k and $k - 1$ levels of aleph. We associate the \mathbb{C}_{\pm}^* extension of \mathbb{C} out of \mathcal{H} in the χ_{\pm}^4 directions with QCD, but not QED, because χ^4 is associated with quarks rather than leptons (Section 0.3). This thinking may provide guidance for the problem regarding the existence of a quantum Yang–Mills theory, but presently we aim only to describe the mass gap. In \mathbb{C}_{\pm}^* , a third pole is enclosed by the lower integration path, and the sum of the enclosed residues will not be zero. The two poles near the origin of $\mathbb{C}_{\{k\}}$ will cancel, but there will be a small remainder somewhere due to the pole on the lower level of aleph. One would attempt to correlate this structure with the existence of the QCD mass gap. Furthermore, one will obtain different values when integrating around the upper or lower complex half-planes. Such discrepancies remedied by the introduction of new theoretical mechanisms.

36 The Banach–Tarski Paradox and Information Density

Consider the series

$$x = 1 + 2 + 4 + 8 + \dots \quad , \quad (36.1)$$

such that

$$x = 1 + 2(1 + 2 + 4 + \dots) = 1 + 2x \quad \implies \quad x = -1 \quad . \quad (36.2)$$

To avoid this result, one often makes a heuristic argument regarding the manipulations of infinite series. However, fractional distance analysis offers new analytical tools with which to define a measure of information density such that the contradiction in (36.2) would be avoided because the parenthetical expression has one less term in it than the series in (36.1). Namely, x has $\widehat{\infty}$ terms in it, but the parenthetical expression

in (36.2) only has $\widehat{\infty} - 1$ terms.¹ Therefore, the parenthetical expression cannot be exactly equal to x , and the false implication does not follow. Such a statement of information density is not possible when $1 + 2 + 4 + \dots$ has ∞ terms in it. New tools which make it possible to quantify this notion of information density should be advanced to the state of some formal treatment.

In 1924, Banach and Tarski (BT) published a set-theoretical decomposition of the unit sphere [160]. They showed that pointwise operations on the set of a sphere's points may be executed such that the recombined points constitute two equal spheres. While some claim that there is no paradox because BT were correct to show that one sphere's points can be used to construct a second, equal sphere, the paradox is that one does not equal two. For instance, one might define the natural numbers in units of spheres. A set with one sphere in it is the number one, etc. Dividing one sphere into its fractional parts should not yield fractions that recombine to more than one sphere. Still, this is the result obtained by BT. No errors have been found in their derivation, so it is called a paradox. To avoid the paradox, one would invoke information density. As an illustration, consider BT's step where the set of terminal up rotations is made congruent to the sets of terminal up, left, and right rotations. After canceling the up operation with a down operation, the information density would be reduced, and the strict equality would be avoided. The $1=2$ paradox is avoided when the naturals are defined in units of spheres *with a certain information density*. As the final two spheres have lower information density than the initial sphere, they cannot quantify the same units as the initial sphere. It remains to formally recompose the result of Banach and Tarski in the language of fractional distance analysis.

37 The Topology of the Real Line

In [2], we have gone to great lengths to define a topology for \mathbb{R} . In the opinion of this writer, it is likely that the work can be extended to show that the topology of \mathbb{R} is \mathbb{S}^0 : the zero sphere. The argument proceeds as follows.

First, [2] meticulously defines the downward representation of geometric objects in algebraic language, but little attention is given to the upward representation of algebraic objects with geometric language. We know it is possible to put an infinite number of algebraic points into a geometric point, but the reverse relationship is not yet determined. By the general similitude of geometric points and algebraic

¹Earlier MCM work in [71] relied on such distinctions between series with $\widehat{\infty}$ implicit terms and with $\widehat{\infty} \pm 1$ implicit terms. The extra term at the end was described as a qubit, and applications of information density toward quantum theory were discussed. Mainly, the inner products of infinite series with odd or even numbers of terms were shown to have "qubit" remainders.

points (numbers), one expects that algebraic points may contain an infinite number of geometric points. If this reciprocity is proven or axiomized, it should be possible to prove that \mathbb{R} has the \mathbb{S}^0 topology. In other words, \mathbb{R} may be represented as two points.¹ Treating only the non-negative branch of \mathbb{R} for simplicity, one would use the result of [2] that geometric points may contain algebraic intervals to resolve geometric points A and B as the algebraic neighborhood of the origin and the maximal neighborhood of infinity respectively:

$$A \equiv [0, \mathcal{F}_0) \quad , \quad \text{and} \quad B \equiv [\mathcal{F}_{\infty-1}, \infty) \quad . \quad (37.1)$$

Recall that $\mathcal{F}_\chi \in \mathbb{F}$ is the supremum of the \mathbb{R}^χ neighborhood of fractional distance. One would convert the intervals to geometric line segments as

$$[0, \mathcal{F}_0) \equiv AA' \quad , \quad \text{and} \quad [\mathcal{F}_{\chi_{\max}}, \infty) \equiv B'B \quad , \quad (37.2)$$

and then proceed to iteratively construct the intermediate algebraic neighborhoods of infinity from A' and B' . It must be examined whether the limit of infinite iterations can be used to show that \mathbb{R} has the 0-sphere topology.

38 The Twin Primes Conjecture

The program described here is highly speculative relative to the work described in other sections. That being stated, one might endeavor to prove the twin primes conjecture as follows. (This approach was first suggested in [161].) Require that the orthogonality of plane waves on different levels of aleph ultimately follows the small box normalization convention (Section 1.7.3) in which the chirological wavenumber β is quantized:

$$\psi_n(x, t, \chi^4) = \exp\{i(kx - \omega t + \beta_n \chi^4)\} \quad , \quad (38.1)$$

Place \mathcal{A} and Ω on the $k \pm 1$ levels of aleph relative to \mathcal{H}_k . Assume the chirological wavenumber in $\mathcal{H}_k \neq \mathcal{H}_0$ is the difference of contributions from \mathcal{A} and Ω :

$$\beta_{k+1} - \beta_{k-1} = \beta_k \quad . \quad (38.2)$$

Develop a framework in which β_k increases by Φ on successive levels of aleph so that

$$\beta_{k \pm n} = \Phi^{\pm n} \beta_k \quad . \quad (38.3)$$

¹A 2-sphere is a hollow ball in 3D space, a 1-sphere is a circle in the plane, and a 0-sphere is two points in a line.

Substituting (38.3) into (38.2) yields

$$\Phi\beta_k - \varphi\beta_k = \beta_k \implies \Phi = 1 + \varphi \quad . \quad (38.4)$$

This must be true when $\beta_k = \Phi^k \beta_0$, so we obtain a general relationship

$$\Phi^{k+1} = \Phi^k + \Phi^{k-1} \quad . \quad (38.5)$$

This is known to be satisfied by the golden ratio Φ . One would find an example in which $k \pm 1$ are twin primes, as would be the case for \mathcal{H}_4 . It is a general idea in the MCM that certain non-classical effects in \mathcal{H}_k should be attributed to contributions from other levels of aleph, e.g.: anti-gravity in mechanical precession (Section 15), and we will attempt to prove the twin primes conjecture by the invariance of \mathcal{H}_k under $k \rightarrow k'$. Such a proof might proceed by induction, but we will give a more specific procedure.

Following a logical program like the sieve of Eratosthenes, one would develop a requirement that contributions from all non-prime levels of aleph are totally attenuated in the bulk lattice; only contributions from prime levels of aleph may contribute to physics in \mathcal{H}_k . One appeals to the fundamental theorem of arithmetic for an appropriate mechanism. Likewise, the Euler product form of the RZF sketches a path by which one is able to eliminate non-prime numbers. Under the given conditions, one would invoke the translational invariance of \mathcal{H}_k for any k to conclude that there must exist an infinite number of twin primes. In other words, if the nodes of a rectangular progression in the golden ratio are associated with a pair of twin primes, then the infinite continuation of the golden spiral will imply an infinite number of such primes because $\Phi^{k+1} = \Phi^k + \Phi^{k-1}$ for any k . As this pertains to the chirological wavenumber, one would find that there must exist infinite twin primes because physics in \mathcal{H}_k cannot depend on the absolute value of k .

39 The Limits of Sine and Cosine at Infinity

The results

$$\lim_{x \rightarrow \infty} \sin(x) = 0 \quad , \quad \text{and} \quad \lim_{x \rightarrow \infty} \cos(x) = 1 \quad , \quad (39.1)$$

derived in [162] rely on $\widehat{\infty}$ having multiplicative absorption but not additive absorption. This has several undesirable implications for basic arithmetic and does not reflect the conventions of the by-now mature framework for fractional distance analysis in \mathbb{R} [2]. Therefore, the result should be revisited under the arithmetic axioms

which remove both of the additive and multiplicative absorptive properties from $\widehat{\infty}$ [2]. It is expected that the result will hold up when the immeasurable, non-arithmetic numbers $x \in \mathbb{F}$ serve as some regularized boundary condition along \mathbb{R} such that the behavior of sine and cosine on approach to $\widehat{\infty}$ along \mathbb{R}^+ is the mirror image of the behavior on egress from the origin. However, further analysis is required to determine whether the result will hold up under the general arithmetic axioms in [2].

If the result will survive, applications toward integrals with infinite bounds and similar problems should be developed. For instance, the Dirac δ function has an integral definition

$$\delta(x) = \frac{1}{2\pi} \int_{-\widehat{\infty}}^{\widehat{\infty}} dk e^{ikx} = \frac{1}{2\pi ix} e^{ikx} \Big|_{-\widehat{\infty}}^{\widehat{\infty}} = \frac{1}{\pi x} \frac{e^{ix\widehat{\infty}} - e^{-ix\widehat{\infty}}}{2i} = \frac{1}{\pi x} \sin(\aleph_x) \quad . \quad (39.2)$$

By the assumed translational invariance of trigonometry functions among neighborhoods of fractional distance, $\sin(\aleph_x) = 0$ because $\sin(0) = 0$. If sine is equal to zero at the center of one neighborhood of fractional distance, it should be equal to zero in the center of all of them. Note the agreement of the assumed $\sin(\aleph_x) = 0$ with

$$\sin(\aleph_x) = \frac{e^{ix\widehat{\infty}} - e^{-ix\widehat{\infty}}}{2i} = \frac{(e^{i\widehat{\infty}})^x - (e^{-i\widehat{\infty}})^x}{2i} = \frac{1 - 1}{2i} = 0 \quad , \quad (39.3)$$

where $e^{\pm i\widehat{\infty}} = 1$ follows from (39.1). If we do not invoke

$$\lim_{x \rightarrow 0^\pm} \frac{1}{x} \quad \longrightarrow \quad \pm \widehat{\infty} \quad , \quad (39.4)$$

then the final step of (39.2) is undefined for $x = 0$. This blow up leads to the $\delta(0) = \infty$ property. To use (39.4), we should examine the product of $(\pi x)^{-1}$ with the series decomposition of sine:

$$\begin{aligned} \lim_{x \rightarrow 0} \frac{1}{\pi x} \sin(\aleph_x) &= \lim_{x \rightarrow 0} \frac{1}{\pi x} \sum_{n=0}^{\infty} c_n \aleph_x^{2n+1} \\ &= \lim_{x \rightarrow 0} \frac{1}{\pi} \sum_{n=0}^{\infty} c_n \aleph_x^{2n} \frac{\aleph_x}{x} \\ &= \lim_{x \rightarrow 0} \frac{1}{\pi} \sum_{n=0}^{\infty} c_n \aleph_x^{2n} \aleph_1 \quad . \end{aligned} \quad (39.5)$$

The $x \rightarrow 0$ limit of \aleph_x requires deeper analysis in the ε - δ framework, as in Section 1.6.9. We have defined $\aleph_0 = 0$ in [2], but \aleph_ε is greater than any natural number for

any real $\varepsilon > 0$. This suggests we might take

$$\lim_{x \rightarrow 0} \aleph_x = \mathcal{F}_0 \quad , \quad (39.6)$$

where \mathcal{F}_0 is the least positive non-arithmetic number. Since $\mathcal{F}_0 > 1$, (39.5) will agree with $\delta(0) = \infty$:

$$\lim_{x \rightarrow 0} \frac{1}{\pi} \sum_{n=0}^{\infty} c_n \aleph_x^{2n} \aleph_1 = \frac{1}{\pi} \sum_{n=0}^{\infty} c_n \aleph_{\mathcal{F}_0^{2n}} \approx \infty \quad . \quad (39.7)$$

On the other hand, if the limit is zero, the resulting expression contains $0 \times \aleph_1 = \aleph_0 = 0$, and we do not immediately obtain the correct behavior for $\delta(x)$ at $x=0$. Such nuance remains to be analyzed. A vast ocean of similar problems will be opened up to new analysis by proof of the limits of sine and cosine at infinity under the axioms of fractional distance analysis.

40 The Cauchy Residue Theorem

The coefficient of the Cauchy residue theorem

$$\oint_C dz f(z) = 2\pi i \sum \text{Res} f(z) \quad , \quad (40.1)$$

contains three of the four ontological numbers. One would attempt to make an extension of complex analysis to \mathbb{C}_{\pm}^* in the form

$$\oint_C dz f(z) = 2\pi i \Phi^{\Delta k} \sum \text{Res} f(z) \quad , \quad (40.2)$$

where k refers to a level of aleph and C acquires a winding number so that it can begin on one level of aleph and end on another. Δk is the change in the level of aleph between the start and endpoints of C , so $\Delta k = 0$ gives the usual formula. While it remains to be determined why the exponent on Φ should be different than those on 2 , π , and i , one understands that $\hat{\Phi}$ is unique for pointing in the direction which allows us to separate the start and end points of C on successive \mathcal{H} -branes. In that case, we slightly abuse the \oint closed path integral notation.

The neighborhood of infinity provides rich new structure around poles. One might envision the poles of a function piercing an infinite number of complex planes such that each intermediate neighborhood of infinity crossed on the approach to the pole is resolved on $\mathbb{C}_{\{k\}}$: the complex plane on the k^{th} level of aleph.

41 Intermediate Numerical Scale

Although fractional distance analysis is strictly a subset of real analysis, this problem calls for a survey of alternatives to \mathbb{R} such as the surreals [163] and hyperreals [164]. In either system, division by an infinite quantity can yield an infinitesimal but never a finite number. Fractional distance was conceived in part to fill this intermediate scale gap with numbers in the neighborhood of infinity such that

$$\frac{\aleph_{\mathcal{X}}}{\infty} = \mathcal{X} . \quad (41.1)$$

For $\mathcal{X} \in (0, 1)$, numbers such as $\aleph_{\mathcal{X}}$ occupy an intermediate numerical scale between infinites and the naturals such that

$$n \in \mathbb{N} \quad \implies \quad \frac{n}{\infty} = 0 . \quad (41.2)$$

Intermediate scale was relied upon heavily in the architecture for a negation of the Riemann hypothesis in [49]. Briefly, an infinitesimal neighborhood around a point and a smaller, nested *hypercomplexly infinitesimal* neighborhood were associated with adjacent odd and even levels of aleph with respect to finite numbers on a third adjacent even level. By scale invariance under shifting levels of aleph, the requirement for two tiers of infinitesimals was found to imply two tiers of finites: numbers in the neighborhood of the origin and those in the neighborhood of infinity. Namely, the scale progression

$$\text{finite} \quad \longrightarrow \quad \text{infinitesimal} \quad \longrightarrow \quad \text{hypercomplexly infinitesimal} , \quad (41.3)$$

was found to imply a similar progression

$$\text{infinite} \quad \longrightarrow \quad \text{intermediate} \quad \longrightarrow \quad \text{finite} , \quad (41.4)$$

under a shift of the level of aleph by two. Aside from [49], another discussion of this requirement may be found in [165]. Given the absence of an intermediate scale in popular extensions of \mathbb{R} containing infinitesimals, one would survey those models attempting to bridge the gap to fractional distance analysis.

Part IV: More Problems in Physics

Many problems in Part IV are concisely presented as surveys of others' work with an eye toward MCM connections. Miscellaneous topics in cosmology appear here as

well.

42 Randall–Sundrum Models

This writer became aware of Randall–Sundrum (RS) models in the years after developing the unit cell. The likeness of these models to the MCM is striking. The main purpose of the work described here will be to cast the MCM unit cell, to the extent that it may be possible, as a third type of RS model beyond the primary RS1 and RS2 models [166, 167].¹

The following is excerpted from [168].

“Randall–Sundrum models (also called 5-dimensional warped geometry theory) are models that describe the world in terms of a warped-geometry higher-dimensional universe, or more concretely as a 5-dimensional anti-de Sitter space where the elementary particles (except the graviton) are localized on a (3+1)-dimensional brane or branes. The two models were proposed in two articles in 1999 by Lisa Randall and Raman Sundrum because they were dissatisfied with the universal extra-dimensional models then in vogue. Such models require two fine tunings; one for the value of the bulk cosmological constant and the other for the brane tensions. Later, while studying RS models in the context of the anti-de Sitter/conformal field theory (AdS/CFT) correspondence, they showed how it can be dual to technicolor models. The first of the two models, called RS1, has a finite size for the extra dimension with two branes, one at each end. [166] The second, RS2, is similar to the first, but one brane has been placed infinitely far away, so that there is only one brane left in the model. [167].

“The model is a braneworld theory developed while trying to solve the hierarchy problem of the Standard Model. It involves a finite five-dimensional bulk that is extremely warped and contains two branes: the Planckbrane (where gravity is a relatively strong force; also called ‘Gravitybrane’) and the Tevbrane (our home with the Standard Model particles; also called ‘Weakbrane’). In this model, the two branes are separated in the not-necessarily large fifth dimension by approximately 16 units (the units based on the brane and bulk energies). The Planckbrane has positive brane energy, and the Tevbrane has negative brane energy. These energies are the

¹The first citation of Sundrum and Randall in [166] is to a paper of Arkani-Hamed and Dvali [5] regarding new dimensions near one millimeter. This paper was cited here in Sections 0.1 and 15 as agreeing with and supporting the characteristic scale for new MCM physics at 10^{-4} m. RS state that their own work is similar to the model presented in [5].

cause of the extremely warped spacetime. In this warped spacetime that is only warped along the fifth dimension, the graviton’s probability function is extremely high at the Planckbrane, but it drops exponentially as it moves closer towards the Tevbrane. In this, gravity would be much weaker on the Tevbrane than on the Planckbrane.”

RS1 is AdS₅ bounded by two branes separated by a finite distance across which spacetime is *warped* in the fifth dimension only. RS warp factor is identical to MCM scale factor, so this is very similar to the MCM scheme for increasing scale along χ^4 . However, the warp factor is not like the continuum of increasingly curved, maximally symmetric MCM branes because the RS warp factor acts uniformly on the entire 4D part of the metric. In RS models, the warping is said to be caused by the energies of the branes, but the MCM approach defines scale as a property of a quantum operator algebra whose analytical underpinnings have not yet been determined. The MCM construction leaves energetic considerations to follow as a consequence when the usual program in physics is that everything should follow from the energy landscape. The alternative, usual view in RS models may be useful for answering questions left open when energy is said to result in the MCM rather than to cause.

Randall and Sundrum (RS) write the following in [166].

“We propose that the metric is not factorizable but rather the four-dimensional metric is multiplied by a ‘warp factor’ which is a rapidly changing function of an additional dimension. The dramatic consequences for the hierarchy problem that we identify [...] follow from the particular non-factorizable metric,

$$ds^2 = e^{-2kr_c\phi}\eta_{\mu\nu}dx^\mu dx^\nu + r_c^2 d\phi^2 \quad , \quad (42.1)$$

where k is a scale of order the Planck scale, x^μ are the coordinates for the familiar four dimensions, while $0 \leq \phi \leq \pi$ is the coordinate for an extra dimension, which is a finite interval whose size is set by r_c .”

RS put the warp factor directly into the metric, but MCM scale factor is associated with renormalization of the observer’s reference frame onto the level of aleph of a given brane. After non-unitary evolution by \hat{M}^3 , unitarity is restored by the scale factor in the brane at the end. The example in Section 0.2 defined unit scale in the \mathcal{H} -brane by an equation in the form

$$g_{\mu\nu} = \Phi g_{\mu\nu}^+ - \varphi g_{\mu\nu}^- \quad , \quad (42.2)$$

where Φ and $-\varphi$ play the role of the RS warp factor $e^{-2kr_c\phi}$ on the branes where we take $g_{\mu\nu}^\pm$. RS achieve unit scale where $\phi=0$ (the Planckbrane), and later in their paper they add an absolute value so the warp factor becomes $e^{-2kr_c|\phi|}$. This is said to cause “the graviton wavefunction” to fall off exponentially quickly away from the Planckbrane, which RS call the *hidden* brane. The hierarchy problem is said to result because the graviton wavefunction has fallen off so greatly by the time it reaches the *visible* Tevbrane at $\phi = \pm\pi$. The absolute value on $|\phi|$ makes RS physics symmetric about the Planckbrane, but scale is not symmetric around MCM branes. This is an important distinguishing feature among RS and MCM models. The main difference between them is that the metric warp factor is the kernel of RS physics, but we have used the KK metric to impose unification of EM and gravitation while putting a warp factor-analogue into the non-unitarity of \hat{M}^3 . Kaluza–Klein theory is the kernel of the metric part of the MCM, and a complete metrical analysis remains to be carried out. Namely, the relative merits of taking $g_{\mu\nu}^\pm$ in (42.2) as the 4D parts of g_{AB}^\pm in the low χ_\pm^4 limits or in the Ω - and \mathcal{A} -branes must be fully evaluated. The detailed metrical analyses in [166, 167] provide a template of important cases and considerations.

The method by which r_c sets the scale of RS’ $\phi \in [0, \pi]$ parameter (actually $\phi \in [-\pi, \pi]$) is the same one by which an arbitrary chronological time between measurements is normalized around $\chi^4 \in [-\varphi, \Phi]$. Where r_c is a constant in RS theory, however, the MCM r_c equivalent will take a unique value in each unit cell because the time interval between measurements may be irregular. In the limit of vanishing A_\pm^μ , the MCM metric

$$g_{AB}^{\text{MCM}} = \begin{pmatrix} g_{\alpha\beta} + \chi^4 A_\alpha A_\beta & \chi^4 A_\alpha \\ \chi^4 A_\beta & \chi^4 \end{pmatrix}, \quad (42.3)$$

has line element

$$ds_{\text{MCM}}^2 = g_{\alpha\beta} d\chi^\alpha d\chi^\beta + \chi^4 (d\chi^4)^2, \quad (42.4)$$

where $g_{\alpha\beta} = \eta_{\mu\nu}$ is implicit for comparison with (42.1). An overall scale factor is implicit as well. The MCM metric reduces to the KK metric through $\chi^4 = \phi^2$ for a scalar field ϕ . In (42.1), constant r_c^2 replaces the KK scalar field.

RS continue as follows [166].

“Because our spacetime does not fill out all of five dimensions, we need to specify boundary conditions, which we take to be periodicity in ϕ , the angular coordinate parameterizing the fifth dimension, supplemented with the identification of (x, ϕ) with $(x, -\phi)$ [...]. We take the range of ϕ to be

from $-\pi$ to π ; however the metric is completely specified by the values in the range $0 \leq \phi \leq \pi$. The orbifold fixed points at $\phi = 0, \pi$ will be taken as the locations of two 3-branes, extending in the x^μ directions, so that they are the boundaries of the five-dimensional spacetime. The 3-branes can support (3+1)-dimensional field theories. Both couple to the purely four-dimensional components of the bulk metric:

$$g_{\mu\nu}^{\text{vis}}(x^\mu) \equiv G_{\mu\nu}(x^\mu, \phi = \pi) \quad , \quad g_{\mu\nu}^{\text{hid}}(x^\mu) \equiv G_{\mu\nu}(x^\mu, \phi = 0) \quad , \quad (42.5)$$

where G_{MN} , $M, N = \mu, \phi$ is the five-dimensional metric. This set-up is in fact similar to the scenario of [Arkani-Hamed *et al. when laying out the case for new dimensions near $10^{-3}m$ in [5].*]

RS introduce a 5D metric G_{MN} whose $\mu, \nu \in \{0, 1, 2, 3\}$ submetrics $G_{\mu\nu}$ correspond to 4D metrics on the bounding branes of the 5D space: the hidden Planckbrane and the visible Tevbrane. Similarly, we have the g_{AB}^\pm metrics for 5D abstract coordinates in Σ^\pm and 4D physical metrics $g_{\alpha\beta}^\pm$ on the bounding branes. $g_{\mu\nu}^{\text{vis}}$ is like the metric on \mathcal{H} (the Tevbrane) and $g_{\mu\nu}^{\text{hid}}$ is like the metric on a hidden \mathcal{A} -, Ω -, or \emptyset -brane. RS assign unit scale factor (warp factor) to the hidden brane whereas we associate unit scale with quantum mechanical unitarity and, thus, the visible \mathcal{H} -brane. However, RS will go on to explain that their model works with either of the Tev- or Planckbranes placed at $\phi=0$.

RS' identification of their boundaries in 5-space as 3-branes shows that they are not considering the timelike part of their AdS_5 space as part of the bulk enclosed by the boundaries. This is another significant departure from the MCM even while it contextualizes what is meant when each \mathcal{H}_k -brane corresponds to a measurement at an observer's proper chronological time t_k . t_k identifies a 3-brane within \mathcal{H}_k , but we will only say that the observer's proper time was t_k when he was in \mathcal{H}_k without reducing the dimensionality of the boundary. Furthermore, RS only consider $\{- + + + +\}$ 5-space while we consider the $\{- + + + \pm\}$ topologies such that complexity is introduced when 3-branes in Euclidean signature $\{+ + +\}$ can be time evolved in more than one way. One envisions modularized dynamical MCM process in which the time evolutions of spacelike 3-branes are alternately chronological and chirological, and wherein we might achieve arbitrage of information around time loops. Processes like $t \rightarrow -it$ Wick rotation might be used to reorient MCM 3-branes with respect to x^0 or χ^4 such that lower case Latin metric counting indices are shifted from $\{0, 1, 2, 3\}$ to $\{1, 2, 3, 4\}$ resulting in non-factorizable mechanisms beyond those considered by RS.

RS continue as follows [166].

“Until this point, we have viewed $M \approx M_{\text{Pl}}$ as the fundamental scale, and the TeV scale as a derived scale as a consequence of the exponential factor appearing in the metric. However, one could equally well have regarded the TeV scale as fundamental, and the Planck scale of 10^{19} GeV as the derived scale. That is, the ratio is the physical dimensionless quantity. From this viewpoint, which is the one naturally taken by a four-dimensional observer residing on the visible brane, the large Planck scale (the weakness of gravity) arises because of the small overlap of the graviton wave function in the fifth dimension (which is the warp factor) with our brane. In fact, this is the only small number produced. All other scales are set by the TeV scale.”

Here, RS point out that the warp factor is such that either of the Planckbrane or the Tevbrane may be taken as the fundamental brane. Likewise, we may represent the unit cell centered on \mathcal{H} or \emptyset . The MCM scale progression in Φ^k suggests that any brane can be taken as the fundamental one with unit scale by a change of variables $k \rightarrow k'$. The RS branes' locations at $\phi=0$ and $\phi=\pm\pi$ —two opposite poles of a circle—imply that we should be able to continue the RS 5-space past the Tev- or Planckbrane, depending on which is placed at $\phi=0$, by unwrapping ϕ from around a cylinder. In RS1 however, the behavior by which the absolute value in (42.6) causes the graviton wavefunction to fall off exponentially quickly away from the Planckbrane cannot be preserved if the Tevbrane is taken as the fundamental scale *and* the fifth coordinate is still continued beyond the Planckbrane. For instance, consider a rescaling $r_c\phi \rightarrow y$ so that (42.1) becomes

$$ds^2 = e^{-2k|y|} \eta_{\mu\nu} dx^\mu dx^\nu + dy^2 \quad , \quad \text{with} \quad y \in \mathbb{R}^0 \quad . \quad (42.6)$$

If the Tevbrane is placed at $y=0$ and y is continued beyond $y=\pm r_c\pi$, then what RS call the graviton no longer falls off exponentially quickly away from the Planckbrane. To cast the MCM as an RS model, it is required to continue y as stated so as to impose an asymmetric scale factor around branes, but this adversely affects the freedom to take the Tevbrane as the fundamental brane. In turn, this should affect MCM freedom to center the unit cell on \mathcal{H} or \emptyset . By allowing the fifth coordinate y to extend beyond the $\phi=\pm\pi$ bounding branes, RS1 can be stepped toward congruence with the MCM, but this breaks another desirable correspondence elsewhere in the model. The extent to which this latter correspondence may be important or required for casting the unit cell as an RS model must be examined. Since symmetry in the $\phi=\pm\pi$ boundaries appears hard-coded in RS models, one might consider two different ϕ -symmetric RS braneworlds and then seek to construct an MCM unit cell as their piecewise union.

The following is excerpted from [168].

“The RS2 model uses the same geometry as RS1, but there is no TeV brane. The particles of the standard model are presumed to be on the Planck brane. This model was originally of interest because it represented an infinite 5-dimensional model, which, in many respects, behaved as a 4-dimensional model. This setup may also be of interest for studies of the AdS/CFT conjecture. [...] In 1998/99 Merab Gogberashvili published on arXiv a number of articles on a very similar theme [169–171].”

The Tevbrane (\mathcal{H}) is absent in the RS2 model. Sometimes it is said that it is moved to infinity whereas the Tevbrane is separated from the Planckbrane by a finite distance in RS1. Considering that the MCM introduces two semi-infinite 5-spaces to induce 4D physics on the boundary between them, one would join two RS2 models as Σ^\pm such that both models’ Tevbranes at infinity become a shared MCM \mathcal{H} -brane (which is not included in either of Σ^\pm .) In another union of RS models, one would simply concatenate \mathcal{H} to one of Σ^\pm so that one 5D space has two bounding branes (RS1), and the other has only one (RS2). The one where \mathcal{H} lies at infinity would be said to reside on a higher or lower level of aleph. The RS1/RS2 union is also interesting because it matches the globally open and closed 4D topologies in the slices of Σ^\pm despite RS1 and RS2 each using the $\{- + + +\}$ 5D topology. Since the RS branes are only 3-branes, RS models of both types may be amenable to embedding in the pseudo-Lorentzian $\{- + + -\}$ topology of Σ^- .

The following is excerpted from [172].

“The Randall–Sundrum model [166, 167] is a class of string theory inspired models in combined cosmology and particle physics, which assume that the observable universe constitutes the asymptotic boundary of an ambient anti de Sitter spacetime: the force of gravity would pertain to the full anti de sitter ‘bulk’ spacetime, but the gauge fields and fermion matter fields would be constrained to reside on that boundary, as would hence be all observations made via electromagnetic radiation by observers inside this cosmology. Hence the extra bulk dimensions in these models need not be small (technically: the fiber spaces need not be compact topological spaces with tiny Riemannian volume) in order to be unobservable for observers. This is in contrast to the (historically much older) Kaluza–Klein compactification models for physics with extra dimensions. Therefore Randall–Sundrum-like models are also referred to as large extra dimension models.”

RS make a similar comment in [167] about their model differing from comparable models by not requiring compactification of dimensions greater than four. Since the MCM scale increases with increasing levels of aleph, it will be prudent to compare it to existing models of large extra dimensions.

43 Brans–Dicke Theory

Scalar-tensor theories are ones in which gravitation is controlled by a rank-2 metric tensor and also a varying scalar field. Brans–Dicke theory [173, 174] is the most prominent example of such a theory. The MCM’s KK metric contains a scalar field ϕ , so the body of literature on such scalar-tensor connections should be surveyed. Brans’ review of scalar fields in physics [175] is likely to contain various insights and tools useful for describing the MCM’s 5D abstract and 4D physical metrics, and the connections between them. Particularly, the generalized Brans–Dicke theory is obtained by converting the Ricci scalar R to a generalized function [176], and this is similar to what we have done by identifying the Ricci scalar $R \propto (\ell_{\pm}^2)^{-1}$ with the KK scalar field via $R = \phi^2 = f(\chi_{\pm}^4)$.

44 The Arnowitt–Deser–Misner Theorem

A 1960 theorem of Arnowitt, Deser, and Misner (ADM) proves that the p^0 component of the universe’s 4-momentum is positive-definite [41]. This result forbids a second universe with $p^0 < 0$ such that the total energy of two universes with opposite time arrows sums to zero. However, this is required for conservation of momentum in cosmogenesis, so the MCM requires modifications in the underpinnings of this theorem.

In [41], ADM suppose that the universe is rotationally and translationally invariant (g_{ik} is isotropic). Then their theorem proceeds in the analysis of non-orientable manifolds. However, modern astrophysical experiments show anomalous multipole correlations in the temperature fluctuations of the cosmic microwave background (CMB). Furthermore, the CMB appears warmer to the north of the plane of the solar system and cooler to the south, and the already mutually correlated CMB quadrupole and octupole moments are further aligned with the axis of this heat distribution. Krauss said the following [177].

“The new results are either telling us that all of science is wrong and we’re the center of the universe, or maybe the data is simply incorrect, or maybe it’s telling us there’s something weird about the microwave background

results and that maybe, maybe there’s something wrong with our theories on the larger scales.”

In an obvious way, if the distance from an observer to a surface is the same in any spatial direction, the CMB at about 14Gcy for example, then the surface is a sphere, and the observer is at its center. This fact places the Earth at the center of the universe. Data from experiments such as WMAP [178] and Planck [179] suggest this arrangement. Such data runs contrary to ADM’s assumption that the universe should be translationally and rotationally invariant on large scales. Land and Magueijo have called this structure the “axis of evil” because it greatly confounds longstanding and well-loved models of cosmology such as the one used in the ADM theorem. Therefore, we have reason to discount the isotropic g_{ij} assumption in the original ADM theorem. Many subsequent, alternative derivations of the ADM theorem have appeared in the intervening decades, and a survey of such work is required to show that any theorem which forbids $p^0 < 0$ necessarily fails in the general case.

A possible workaround for avoiding the theorem’s implication proceeds as follows. ADM assign a differential element of area to the surface at spacelike infinity in the form [41]

$$dS_i = \frac{1}{2} \varepsilon_{ijk} dx^j dx^k \quad . \quad (44.1)$$

However, orientable manifolds may be equipped with symplectic forms on their boundaries. The consequence of ADM’s work may be avoided if one rejects (44.1) in favor of

$$dS_i = \frac{1}{2} \varepsilon_{ijk} dx^j \wedge dx^k \quad . \quad (44.2)$$

The $dx^j \wedge dx^k = -dx^k \wedge dx^j$ property of the wedge product nullifies the ADM theorem when the opposite sign carries through to allow positive- or negative-definite energy. Although the Levi–Civita symbol reverses the sign with permutations of j and k , it cannot be determined if the positively signed case in (44.1) should correspond to $dx^j \wedge dx^k$ or $dx^k \wedge dx^j$.

Since the universe \mathcal{H} connects to Σ^\pm via some exotic geometry, one would examine the cases for symplectic 2-forms at spacelike infinity. If it can be demonstrated absolutely that (44.2) is the proper surface element, then the implication following from (44.1) will be avoided, as is required.

45 The Borde–Guth–Vilenkin Theorem

The Borde–Guth–Vilenkin (BGV) theorem is said to rule out any model of cosmology in which time extends infinitely far into the past. In [57], BGV give a simple argument proving that a past spacetime boundary must exist for expanding spacetimes with metric

$$ds^2 = dt^2 - a(t)d\mathbf{x}^2 \quad . \quad (45.1)$$

After proving the case of a toy model, they proceed to prove the general case similarly. The proof for the toy model begins with the differential element of the null interval in the space described by (45.1):

$$d\lambda \propto a(t)dt \quad . \quad (45.2)$$

This may be normalized as

$$d\lambda \propto \frac{a(t)}{a(t_f)}dt \quad , \quad (45.3)$$

for some reference time t_f . Using the standard definition of the Hubble parameter

$$H = \frac{\dot{a}}{a} \quad , \quad (45.4)$$

the authors integrate H from an early time to t_f :

$$\begin{aligned} \int_{\lambda(t_i)}^{\lambda(t_f)} H(\lambda)d\lambda &= \int_{t_i}^{t_f} \frac{\dot{a}(\lambda)}{a(\lambda)} d\lambda \\ &= \int_{t_i}^{t_f} \frac{\dot{a}(t)}{a(t)} \frac{a(t)}{a(t_f)} dt \\ &= \int_{t_i}^{t_f} \frac{d}{dt} \frac{a(t)}{a(t_f)} dt \\ &= \int_{a(t_i)}^{a(t_f)} \frac{da}{a(t_f)} \\ &= \left(1 - \frac{a(t_i)}{a(t_f)} \right) \leq 1 \quad . \end{aligned} \quad (45.5)$$

The authors then define an average Hubble parameter H_{av} over the affine parameter λ :

$$H_{\text{av}} = \frac{1}{\lambda(t_f) - \lambda(t_i)} \int_{\lambda(t_i)}^{\lambda(t_f)} H(\lambda)d\lambda \leq \frac{1}{\lambda(t_f) - \lambda(t_i)} \quad (45.6)$$

According to the metric in (45.1), the universe has always been expanding, and it follows that $H_{\text{av}} > 0$. Since (45.6) shows that the average has to be less than or equal to the given fraction, the affine parameter is constrained to some finite length. H_{av} is greater than zero, but the fraction goes to zero as $\lambda(t_i) \rightarrow -\infty$. Thus, $H_{\text{av}} > 0$ requires that the time interval parameterized by λ cannot extend infinitely far into the past.

The BGV theorem does not cover the case of χ^4 extending infinitely far into the chirological past, so the theorem does not disrupt the presumed infinite extent of the MCM cosmological lattice. While the MCM does not necessarily depend, at this point, on a cyclic cosmology model in which timelike chronological geodesics must extend infinitely far into the past, the introduction of a reversed time arrow at the past spacetime boundary implied by (45.6) may provide a workaround for the implication of the BGV theorem. Rather than forcing past incompleteness, the BGV theorem might be shown to force sign-alternating piecewise structure onto the affine parameterization of geodesics longer than some scale.

46 The Ehrenfest Paradox

The Ehrenfest paradox [180] pertains to a spinning disc whose outer edge moves at relativistic speeds. The radius of the disc is always perpendicular to the motion of the disc's elements and should not be affected by special relativistic length contraction. The circumference of the disc, however, is parallel to the tangential velocity of the disc's elements and must be affected by length contraction. As a consequence, the ratio π between the non-spinning disc's radius R_0 and circumference C_0 cannot be the ratio of R_0 to the spinning disc's circumference C . An extensive analysis of this problem appears in [181] wherein Grøn emphasizes a historical preoccupation with the elastic properties of a hypothetical disc as well as the feasibility of making properly comoving measurements to observe the ratio $C/R \neq 2\pi$. Without regard to the material properties of a physical disc or the possibility of any specific experiment, the Ehrenfest paradox is a fascinating problem in pure geometry.

Framing this process in the MCM, one would examine the case in which π is factored out of Lorentz contraction in a rotating reference frame as

$$|\psi; \hat{\pi}\rangle \longrightarrow \underbrace{|\psi\rangle}_{\text{relativistic}} \times \underbrace{\hat{\pi}}_{\text{abstract}} . \quad (46.1)$$

This possibility is directly falsifiable. If the mechanism is not immediately determined to be infeasible, one would compare any results to known gravitational anomalies such

as the Pioneer anomaly [182].¹ Small deviations from the predicted orbit might be assigned to a non-relativistic $\hat{\pi}$.

47 The Ford Paradox

In [184], Locklin writes the following about the Ford paradox [185, 186].

“If quantum mechanics is the ultimate theory of the universe: where do the long strings of random bits come from in a classically chaotic system? Since people believe that QM is the ultimate law of the universe, somehow we must be able to recover all of classical physics from quantum mechanics. This includes information generating systems like the paths of chaotic orbits. If we can’t derive such chaotic orbits from a QM model, that indicates that QM might not be the ultimate law of nature. Either that, or our understanding of QM is incomplete. Is there a point where the fuzzy QM picture turns into the classical bit generating picture? If so, what does it look like in the transition?”

“I’ve had physicists tell me that this is ‘trivial,’ and that the ‘correspondence principle’ handles this case. The problem is, classically chaotic systems egregiously violate the correspondence principle. Classically chaotic systems generate information over time. Quantum mechanical systems are completely defined by stationary periodic orbits. To say the ‘correspondence principle handles this’ is to merely assert that we’ll always get the correct answer, when, in fact, there are two different answers. The Ford paradox is asking the question: if QM is the ultimate theory of nature, where do the long bit strings in a classically chaotic dynamical system come from? How is the classical chaotic manifold constructed from quantum mechanical fundamentals?”

While the above pertains to the chaotic double pendulum, one might ask where large scale turbulence in the universe comes from if the big bang was a *quantum* nucleation event. If quantum mechanics was the supreme law in the evolution of the universe, it would follow that the universe could have only become a perfectly symmetric crystal devoid of the information needed to characterize turbulent macro-scale structures. Since QM is an information-conserving theory, the universe at late times would not contain more information than was in the initial qubit.

¹The current reliance on finite element analysis to diagnose the Pioneer anomaly as a heat issue [183] is unsatisfying to this writer. The small effect obtained in this analysis is as likely to be an artifact of the choice of finite elements as it is to be a real effect, in the opinion of this writer.

Locklin also writes the following [184].

“This may seem subtle, but according to quantum mechanics, the ‘motion’ is completely defined by periodic orbits. There are no chaotic orbits in quantum mechanics. In other words, you have a small set of periodic orbits which completely define the quantum system. If the orbits are all periodic, there is less information content than orbits which are chaotic. If this sort of thing is true in general, it indicates that classical physics could be a more fundamental theory than quantum mechanics.”

While the Ford paradox is little regarded by the physics orthodoxy, it was instrumental in this writer’s thinking during the formation of the MCM. Fundamentally, the increase of entropy in real systems requires that total information is not conserved. This is not possible in the framework of quantum mechanics. The introduction of irrational numbers to the scale factor associated with non-unitary \hat{M}^3 is proposed in part to generate the anomalous (but required) long strings of random bits needed to describe simple experiments and, eventually, large scale turbulence in the universe, e.g.: crashing ocean waves, terrestrial clouds, astrophysical nebulae, etc. As an example, new information might enter a theory when the arguments of sines and cosines periodic in 2π are rescaled as $n\pi x \rightarrow n\pi\Phi x'$. Cases of this paradox must be surveyed and analyzed in the modified framework of quantum mechanics dependent on \hat{M}^3 .

48 Intrinsic Periodicity

A program of Dolce, e.g.: [187–190], pertains to the periodicity intrinsic to quantum states through the de Broglie wavelength. Dolce endeavors to associate this manifestation of wave-particle duality with more fundamental periodicities in time and space. Given the MCM particle scheme in which fundamental particles are themselves quanta of spacetime more so than they are the “isolated energy parcels” described by de Broglie [191], a survey of Dolce’s program is likely to yield results, methods, and language appropriate for use in the MCM. Particularly, Dolce has considered the case of a virtual extra dimension in [189]. The MCM’s fifth *abstract* dimension may be more appropriately classified as a canonically virtual dimension than a real spacelike or timelike one. The distinctions of such dimensions must be analyzed and incorporated into the MCM to the extent that they are useful.

49 Non-Local Hidden Variables

Bell’s theorem is said to preclude the existence of local hidden variables in quantum theory. ’T Hooft states Bell’s theorem as follows [192].

“No physical theory of local hidden variables can ever reproduce all of the predictions of quantum mechanics.”

A hypothetical MCM workaround for this theorem was meant to allow χ^4 as a local hidden variable [193]. However, the mechanism relies on several unresolved *if* statements, and subsequent analysis shows that χ^4 may be better described as a non-local hidden variable than a local one.¹ Therefore, it is required to establish χ^4 as a non-local variable or to manufacture a rigorous refutation of Bell’s theorem.

50 Λ CDM Cosmology

Energy equations are rarely sufficient to determine unique solutions in cosmology. In general, equations of state are required before one may form a system of N cosmology equations in N unknowns. In this research program, we have not considered pressures and densities at all. We have only loosely alluded to the associations of AdS and dS with positive and negative cosmological constants, but those constants are intimately linked to the thermodynamic state of a universe. Λ CDM models cover all standard thermodynamic cosmology states, so these models must be canvassed for the additional constraint equations required in a mature model of cosmology, e.g.: Chapter 27 in [194] or Chapter 8 in [195].

51 The Landau–Yang Theorem

Although Particle Data Group reports each year that it has not yet been determined if the Higgslike particle decays to two photons, e.g.: [17, 27, 125, 126], it is said that spin-1 is ruled out for that particle by the Landau–Yang theorem *because the particle has been observed to decay to two photons*. In either case, a review of this theorem [196, 197] and its foundation in spin-statistics is in order. If it is eventually determined that the Higgslike particle decays to two photons, might there be a workaround for the implication of the Landau–Yang theorem that spin-1 is consequently forbidden? The foundations of this theorem must be analyzed to determine whether or not new principles inherent to the MCM might introduce corner cases which have not been previously considered.

¹The information and correlations of local variables are limited by the speed of light.

52 A Clopen Universe

While it is an open question whether or not the physical universe is topologically flat, all data indicates that the deviation from topological flatness on cosmological scales is very small if it exists at all. However, the 4D de Sitter and anti-de Sitter slices of the MCM unit cell have positive and negative curvature respectively corresponding to topological open- and closedness. The \mathcal{H} -brane can smoothly sew together the geometries of the low curvature limits of the slices of Σ^\pm , but the topology of \mathcal{H} cannot smoothly merge these incompatible topologies. An eccentric topology beyond closed and open is the *clopen* topology. Something is said to be clopen if it is both open and closed. One would conduct a survey of the properties of clopen spaces with the goal of better understanding connections between Σ^\pm . One would seek to develop cosmological observables related to topological clopenness in the \mathcal{H} -brane.

53 The Galactic Rotation Anomaly

To a hammer, every problem looks like a nail. This is the main reason why particle physicists insist on solving the galactic rotation anomaly with particles despite a mountain of non-confirming evidence. So many experiments have failed to detect even the slightest hint of dark matter that modern dark matter models are hopelessly contrived and unrealistic. At the heart of this active research area is a large federal budget for grants related to dark matter investigations. Without that, most reasonable scientists would have given up on the particle theory of dark matter by now. Dozens or hundreds of experiments have failed to find any evidence.

Underlying a hypothetical, undetectable or nearly undetectable, novel form of matter called dark matter is the galactic rotation anomaly. The tangential velocities of stars on the outer rims of spiral galaxies are too large for those stars to be held within their galaxies by the gravity of the visible matter. Thus, it was originally speculated that there must be some additional, invisible matter called *dark matter* responsible for the gravitational binding of the fast-moving stars on the rim. In analogy, if one pours sand on a dinner plate and begins to spin the plate, the sand will begin to fly off from the outer edge of the plate once the velocity exceeds what can be offset by the sand's friction force on the plate. Likewise, certain stars should be thrown out of their galaxies, but that is not what is observed. The anomaly by which stars remain on the spinning plate is very real, but, in light of overwhelming experimental evidence, there is little to no good reason to suppose that a new form of particulate *dark* matter generates the required gravitation. As stated above, it is

this writer’s opinion that all or nearly all interest in such models pertains to a large pool of funding for what is effectively a dead research area. Such research is kept alive because there is always a risk that funds will be diverted to sociology rather than other problems in physics.

As an alternative to a novel, dark form of matter, one would attempt to account for the anomalous gravitation by exploring galactic geometries other than the simplest ones which can be extracted from 2D astronomical data recorded by telescopes. For instance, one would explore the gravitational energy of 4D galactic geometries rather than only 3D geometries. The MCM suggests dark energy as a cosmological effect when the universe gravitates toward another universe (or itself) in the future (Section 7), and one would also explore localized galactic manifestations of such effects. Might the mass of the galaxy in the future gravitate with visible matter on our past light cone? Might other, more exotic galactic configurations be consistent with 2D astronomical data and also able to account for the anomalous gravitation? Matter hidden from our telescopes by exotic geometries might be labeled “dark” without reference to new particles absent from the standard model.

An anomalous correlation of supermassive black hole masses with the masses of their host galaxies is further evidence that one ought to explore alternative models of galactic physics. Present models predict that a black hole in the center of a galaxy should not know anything about the mass of the galaxy itself, but observations show that heavier galaxies tend to host heavier supermassive black holes [198,199]. Rather than posing dark matter for one anomaly and another theory for the other, one would seek a new model of galactic physics in which to resolve both issues.

54 Neutrino Helicity

The standard model predicts that all neutrinos should exist in left-handed helicity states. However, observed neutrino flavor oscillations [200–202] require that neutrinos must exist in left- and right-handed helicities. This major deficiency of the standard model’s wrong prediction should be examined in the context of the MCM particle scheme. Relative to conserved parity for strong and EM interactions, one would seek to identify a mechanism in the structure of the unit cell for parity non-conservation in weak interactions. One would develop MCM cases for Dirac and Majorana neutrinos and study the standard model case in which right-helical Dirac neutrinos cannot interact via the weak interaction. One would attempt to attribute the standard model prediction to inherent directionality in \hat{M}^3 .

In one further portion of neutrino physics, one might revisit the MCM particle

scheme (Section 0.2) in which neutrinos are differentiated from their charged lepton partners by the handedness of a $\{x^0, x^i, \chi^4\}$ coordinate system. As mentioned in Section 1.9.1, the subsequent introduction of $\widehat{\infty}$ may allow us to distinguish charged lepton/neutrino pairs between coordinate triads located at either of $\widehat{0}$ or $\widehat{\infty}$ rather than between right- and left-handed ones. Such an arrangement might lend itself to the large mass ratios among charged and neutral leptons, and to a longstanding prediction for massless neutrinos which was ultimately rejected on the basis of neutrino oscillations. In an intuitive way, one would associate zero mass with $\widehat{0}$ or $\widehat{\infty}$, and then develop an allowance for a small non-zero mass pertaining to the neighborhood of infinity. To avoid similar mass ratios among generations of quarks paired according to $\widehat{0}$ and $\widehat{\infty}$, one would appeal to the piecewise structure of χ^4 relative to x^0 .

55 Local Gauge Symmetry

Consider the standard model of particle physics' group theoretical structure $SU(3) \times SU(2) \times U(1)$. While there are variations on the standard model which are allowed, this algebraic structure seems to be enforced at the experimental level. The $U(1)$ part describes, loosely, the oscillations of the EM field. From one point in spacetime to another, the EM field has a $U(1)$ symmetry such that \mathbf{E} is determined by $\theta \in [0, 2\pi)$ and \mathbf{B} is determined consequently by overall relativistic invariance. Every possible value of the EM field at a point can be obtained by applying a $U(1)$ rotation to the value of θ at any other point. Therefore, we say that the EM field has a $U(1)$ phase at each point. In quantum mechanics, the $U(1)$ gauge symmetry allows us to make changes like $\psi \rightarrow e^{i\lambda}\psi$ as long we make corresponding *gauge transformations* elsewhere in the theory. In this case, the $U(1)$ circle group describes the 2π radian periodicity in the function $e^{i\lambda} = e^{i\lambda+2\pi}$. The $SU(2)$ weak theory is slightly more complicated. It adds a 2-sphere of coordinate freedom to each point in spacetime and the $U(1)$ part of the $SU(2) \times U(1)$ electroweak theory pertains to *hypercharge* rather than electric charge. The $SU(3)$ strong force adds a 3-sphere to each point. The strong force at any point can be obtained by rotating three QCD angles defined at any other point. These degrees of freedom assigned to the points of spacetime are called local gauge symmetries.

Following the MCM particle scheme in which gravitational manifolds are like elementary particles, one would link the dynamical quantum metric defined with four degrees of freedom to a new local QFT gauge symmetry. In other words, the internal coordinates associated with the gauge symmetries at a point on one level of aleph would be like the coordinates of a gravitational manifold on another level of aleph.

This description of metrical degrees of freedom as local gauge symmetries may be useful in MCM quantum gravity which resolves quantum states as metric tensors. For example, the necessary slow variation of x^μ Cartesian coordinates in spacetime relative to an $SU(4)$ representation of those coordinates as four angles may be germane to the hierarchy problem.

56 The Amplituhedron

In late 2013, several months after the first publication of the unit cell in [7], Arkani-Hamed and Trnka published a famously received paper describing an “amplituhedron.” They write the following in [203].

“Perturbative scattering amplitudes in gauge theories have remarkable simplicity and hidden infinite dimensional symmetries that are completely obscured in the conventional formulation of field theory using Feynman diagrams. This suggests the existence of a new understanding for scattering amplitudes where locality and unitarity do not play a central role but are derived consequences from a different starting point. In this note we provide such an understanding for $N=4$ [*supersymmetric Yang–Mills theory (SYM)*] scattering amplitudes in the planar limit, which we identify as ‘the volume’ of a new mathematical object—the Amplituhedron.”

“[*T*]here must be a different formulation of the physics, where locality and unitarity do not play a central role, but emerge as derived features from a different starting point. A program to find a reformulation along these lines was initiated in [*two omitted Arkani-Hamed papers*], and in the context of a planar $N=4$ SYM was pursued in [*three other omitted Arkani-Hamed papers*], leading to a new physical and mathematical understanding of scattering amplitudes [*in another omitted Arkani-Hamed paper*].”

The new object with volume is the authors’ version of the unit cell. Following the program of Ashtekar [50, 58], Finkelstein [147–153], *and others*, Arkani-Hamed and Trnka appear to suggest that they were barking up the same tree as this writer, at the same time, and without delivering any hard new results of their own, at that time or subsequently.¹ As Finkelstein was so enchanted by the idea to model the big bang with a Feynman diagram (Figure 29), the 2013 comment of Arkani-Hamed and Trnka regarding post-Feynmanian understanding of scattering amplitudes suggests

¹To the contrary, this writer has parlayed early thinking into the negation of the Riemann hypothesis [2, 47, 48], a formidable result of hard matériel, and made numerous other technical advances.

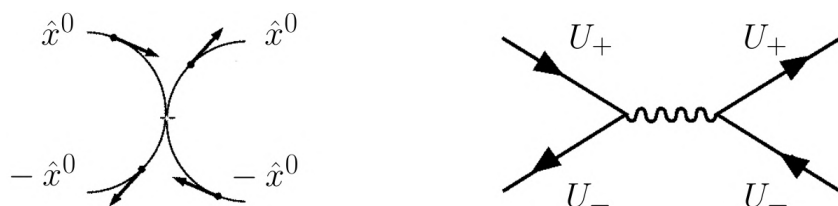

Figure 29: This figure is adapted from [40]. The original caption read, “A duality transformation between the geometric and particle pictures.”

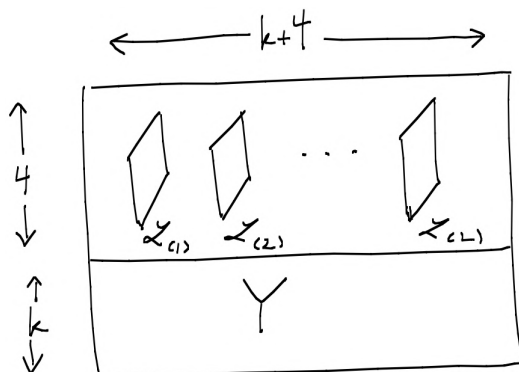

Figure 30: This figure is due to Arkani-Hamed and Trnka [203]. We suggest that this figure is intended to invoke the likeness of the MCM unit cell. The “4” written to the left apparently refers to the dimensionality of the MCM’s labeled branes, and k refers to an unspecified number of embedding dimensions: the MCM’s χ_{\pm}^4 (and χ_{\emptyset}^4 .)

that they were enamored of the idea as well, and rightly so. The reader is reminded that a modestly similar likeness demonstrated by Maldacena became *the most cited paper* in the high energy particle physics literature [59] despite Maldacena not having demonstrated what new physics or precise new understanding might be gained by the AdS/CFT correspondence. The likeness between the anti-de Sitter space and a conformal field theory in one less dimension speaks for itself. Masterful scholars infer from the likeness alone that it should be important *for something*. Indeed, it is likely that far more physicists were excited by the MCM particle-spacetime duality than were this writer, Arkani-Hamed, and Finkelstein, c.f.: Appendix C.

Arkani-Hamed and Trnka continue as follows.

“[W]e can now give the full definition of the amplituhedron[.] [...] The amplituhedron lives in $G(k, k + 4; L)$: the space of k planes Y in $(k + 4)$ dimensions, together with L 2-planes \mathcal{L}_i in the 4 dimensional complement

of Y , [as in Figure 30.] [...] The amplituhedron $A_{n,k,L}(Z)$ is the subspace of $G(k, k+4; L)$ consisting of all \mathcal{Y} 's which are a positive linear combination of the external data[.] [...] The notion of cells, cell decomposition and canonical form can be extended to the full amplituhedron. A cell Γ is associated with a set of positive coordinates $\alpha^\Gamma = (\alpha_1^\Gamma, \dots, \alpha_{4(k+L)}^\Gamma)$, rational in the \mathcal{C} , such that for α 's positive, $\mathcal{C}(\alpha) = (D_{(i)}(\alpha), C(\alpha))$ is in $G_+(k, n; L)$. A cell decomposition is a collection T of non-intersecting cells Γ whose images under $\mathcal{Y} = \mathcal{C} \cdot Z$ cover the entire amplituhedron."

In the opinion of this writer, Arkani-Hamed examined the unit cell and envisioned Figure 30 as his own alternative ideation. After that, all of the language about, "generalizing the notion of the inside of a triangle in a plane," [203] (not excerpted) was reverse engineered to develop a context for Figure 30 without being forced to acknowledge the MCM or ideation from this writer. Indeed, Arkani-Hamed and Trnka appear to go much farther than their peers in generating a paper trail to suggest their own parallel ideation. To wit, after sufficiently *generalizing the inside of a triangle*, Arkani-Hamed and Trnka state the above in which a decomposable Γ takes the place of $\Sigma^+ \cup \Sigma^-$. The "entire amplituhedron" is presumably the analogue of the MCM bulk cosmological lattice. The authors' following claim (below) to be motivated by the idea of the area of dual polygon is more evidence that the main goal of their paper was to rephrase the MCM's dual Σ^\pm structure in the context of their own legitimate research, and a smattering of nonsense given as excuse.

"While cell decompositions of the amplituhedron are geometrically interesting in their own right, from the point of view of physics, we need them only as a stepping stone to determining the form $\Omega_{n,k,L}$. This form was motivated by the idea of the area of a (dual) polygon."

It seems unlikely to this writer that hot-shot particle physicists at the Institute for Advanced Study would have found spontaneous and profound inspiration in a polygon's dual having an area. In the opinion of this writer, the amplituhedron is more evidence of the great worth of this writer's ideas being immediately apparent to everyone exposed to them, barring those less expert in physics. As with pseudo-plagiaristic rewrites lacking proper acknowledgment of ideation in other sections, one would survey work pertaining to the amplituhedron to determine if any new insights were had and whether or not any of them might be useful for developing the MCM.

57 Time Crystals

A time crystal is a physical system which is periodic in time. The MCM unit cell is an example of a time crystal, and, indeed, the term “unit cell” is taken from the physics of crystalline solids. Wilczek’s and Shapere’s time crystal papers [52, 204] appeared on arXiv in February 2012, a year before the unit cell was published in [7]. Therefore, we will consider the classical time crystal paper authored by Shapere and Wilczek, and the quantum time crystal paper authored by Wilczek alone, as response papers¹ to the time periodicity attributed to \hat{M}^3 near the end of 2011 [30, 40]. To Wilczek’s credit, he seems only to analyze the possibilities related to \hat{M}^3 without attempting to fabricate a parallel construction. He writes the following [52].

“Symmetry and its spontaneous breaking is a central theme in modern physics. Perhaps no symmetry is more fundamental than time translation symmetry, since time translation symmetry underlies both the reproducibility of experience and, within the standard dynamical frameworks, the conservation of energy. So it is natural to consider the question, whether time translation symmetry might be spontaneously broken in a closed quantum mechanical system. That is the question we will consider, and answer affirmatively, here. Here we are considering the possibility of time crystals, analogous to ordinary crystals in space. They represent spontaneous emergence of a clock within a time-invariant dynamical system. [...]

“Several considerations might seem to make the possibility of quantum time crystals implausible. The Heisenberg equation of motion for an operator with no intrinsic time dependence reads

$$\langle \Psi | \dot{\mathcal{O}} | \Psi \rangle = i \langle \Psi | [H, \mathcal{O}] | \Psi \rangle \xrightarrow{\Psi = \Psi_E} 0, \quad (57.1)$$

where the last step applies to any eigenstate Ψ_E of H . This seems to preclude the possibility of an order parameter that could indicate the spontaneous breaking of infinitesimal time translation symmetry. Also, the very concept of ‘ground state’ implies state of lowest energy; but in any state of definite energy (it seems) the Hamiltonian must act trivially. Finally, a system with spontaneous breaking of time translation symmetry in its ground state must have some sort of motion in its ground state, and is therefore

¹These papers are very good, concise, and readable. The mathematical analysis therein is greatly contrasts the mathematical content of [203] (Section 56) in that it cannot be considered math salad by any stretch of the imagination. Wilczek’s and Shapere’s math is math as it is meant to be. Both papers are models of good work in fundamental physics, excepting the likely lack of a due acknowledgment.

perilously close to fitting the definition of a perpetual motion machine.”

In [204], Shapere and Wilczek state the following.

“When a physical solution of a set of equations displays less symmetry than the equations themselves, we say the symmetry is spontaneously broken by that solution.”

One understands that the three-fold process for \hat{M}^3 gives a context in which general classes of solutions might display far more complex behavior than is immediately apparent in $\mathcal{H} \rightarrow \Omega \rightarrow \mathcal{A} \rightarrow \mathcal{H}$. Particularly, Wilczek’s attention to violation of time reversal symmetry in [52] places the content of his paper later than the postulation of \hat{M}^3 [30, 40] but earlier than the postulation of the unit cell [7]. In 2012, \hat{M}^3 would require violation of time translation symmetry for a particle at rest, presumably in the ground state, to move in a periodic motion among $\{\mathcal{A}, \mathcal{H}, \Omega\}$. This reflects the $t_0 \rightarrow t_{\max} \rightarrow t_{\min} \rightarrow t_0$ convention of [30, 40], but the subsequent introduction of the chirological time spanning the unit cell in 2013 [7] sidesteps the main thrust of Wilczek’s paper. Still, time crystals were affirmatively observed in 2016 [205], and we have very much designed the unit cell to function like a clock: the ticking of \hat{M}^3 from one observation to the next marks the chirological time. The constant cycling among the branes of the unit cell during repeated observations of a system in its ground state is very much like perpetual motion, but abstract perpetual motion in the bulk of the unit cell may not be prohibited as is physical perpetual motion in \mathcal{H} .

The point raised by (57.1) is that any order parameter, call it the expectation value $\langle \mathcal{O} \rangle$, which might indicate spontaneous symmetry breaking by a transition from trivial into more complicated behavior is forbidden in the ground state due to the expectation value of $\dot{\mathcal{O}}$ being equal to zero. By imposing the overall symmetry condition (periodicity) in the unit cell in the χ^4 direction, we do not impose any new symmetries on the x^μ part of a Hamiltonian, so the extent to which Wilczek’s work on symmetry breaking is in scope for the current iteration of the MCM must be evaluated.

Following the wrap-the- x^0 -axis-around-cylinder program of the earliest incarnation of the MCM [31], Wilczek cites a ring particle as an exception to his previous comment regarding the preclusion of an order parameter (not excerpted.) For an angular coordinate ϕ and a Lagrangian

$$L = \frac{1}{2} \dot{\phi}^2 + \alpha \phi \quad , \quad (57.2)$$

Wilczek makes the following remarks.

“If α is not an integer, we will have

$$\langle l_0 | \dot{\phi} | l_0 \rangle = l_0 - \alpha \neq 0 \quad . \quad (57.3)$$

The case when α is half an odd integer requires special consideration. In that case we will have two distinct states $|\alpha \pm \frac{1}{2}\rangle$ with the minimum energy.”

The case of α being half an odd integer leading to two ground states deserves closer study because it is qualitatively suggestive of the Σ^\pm structure as well as the structure of the fundamental fermions in the MCM particle scheme. Wilczek makes other remarks regarding multiple ring particle wavefunctions behaving as Cooper pairs. The utility of this language must also be evaluated for descriptions of the U_\pm universes’ particle descriptions. The language of Cooper pairs is well suited to the picture of U_\pm universes in simultaneous, isentropic cosmological bouncing.

Further hinting at an underlying ideation in the MCM, Wilczek writes the following [52].

“It is interesting to speculate that a (considerably) more elaborate quantum-mechanical system, whose states could be interpreted as collections of qubits, might be engineered to traverse, in its ground configuration, a programmed landscape of structured states in Hilbert space over time. [...] The a.c. Josephson effect is a semi-macroscopic oscillatory phenomenon related in spirit to time crystallization. It requires, however, a voltage difference that must be sustained externally.”

One speculates that the more elaborate system is the one described by $\mathcal{H} \rightarrow \Omega \rightarrow \mathcal{A} \rightarrow \mathcal{H}$ which became the unit cell and its accoutrements detailed in Section 1. The Josephson junction is the main experimental protocol for measuring the fine structure constant, and a comment of Shapere and Wilczek in [204] about higher powers of velocities appearing naturally seems to refer to the third derivative application for $\alpha_{\text{MCM}}^{-1} = 2\pi + (\Phi\pi)^3$. Another comment in [204] about converting space derivatives into time derivatives seems to refer to the statement

$$\hat{U} \propto \partial_x \quad , \quad \text{and} \quad \hat{M} \propto \partial_t \quad , \quad (57.4)$$

which was the main proposal for a new mathematical method before χ^4 was introduced in [7]. Therefore, one questions the words of Ledesma-Aguilar [206]:

“Back in 2012, Wilczek came up with a tantalizing idea. He wondered if, in the same way that a crystal breaks symmetry in space, it would be

possible to create a crystal breaking an equivalent symmetry in time. This was the first time the idea of a time crystal was theorized.”

As stated above, it is to Wilczek’s credit that he has not fabricated some fictitious path toward the idea of time crystals. He simply writes about the idea. Despite Wilczek not making any claim toward independent ideation, however, his non-citation to the MCM facilitates the above easy and natural misconception. Similarly, Weinstein never claimed to have formulated the theory of “Geometric Unity” (to the knowledge of this writer) [207], but his failure to attribute the original ideation to Tooker facilitated a profound and rampant misconception.

It remains true that time crystals were observed in 2016 [205], and the topic is an active research area in fundamental physics today. The main results in the field [205,208–210] must be surveyed and evaluated for applications in the MCM. The main question will be whether the current structure of the MCM unit cell requires the breaking of time translation symmetry, and, if it does, whether or not χ^4 should be useful as an order parameter characterizing the broken symmetry.

58 Cellular Automata

’T Hooft has written a book called *The Cellular Automaton Interpretation of Quantum Mechanics* [211] which begins as follows.

“This book is about a theory, and about an interpretation. The theory, as it stands, is highly speculative. It is born out of dissatisfaction with the existing explanations of a well-established fact. The fact is that our universe appears to be controlled by the laws of quantum mechanics. Quantum mechanics looks weird, but nevertheless it provides for a very solid basis for doing calculations of all sorts that explain the peculiarities of the atomic and sub-atomic world. The theory developed in this book starts from assumptions that, at first sight, seem to be natural and straightforward, and we think they can be very well defended.

“Regardless whether the theory is completely right, partly right, or dead wrong, one may be inspired by the way it looks at quantum mechanics. We are assuming the existence of a definite ‘reality’ underlying quantum mechanical descriptions. The assumption that this reality exists leads to a rather down-to-earth interpretation of what quantum mechanical calculations are telling us. The interpretation works beautifully and seems to remove several of the difficulties encountered in other descriptions of how

one might interpret the measurements and their findings. We propose this interpretation that, in our eyes, is superior to other existing dogmas.”

’T Hooft expresses the same interest in going beyond quantum mechanics which motivates the MCM. Fortunately, one finds evidence in the literature [212,213] that ’t Hooft was pursuing such ideas before the MCM was constructed. Indeed, ’t Hooft’s references to the problem of information loss (Section 47) in [211,212] paint a picture of his interests being well aligned with those of this writer. Regarding the specifics of his model, he writes the following.

“A *cellular* automaton is an automaton where the data are imagined to form a discrete, d -dimensional lattice, in an $n = d + 1$ dimensional space-time. The elements of the lattice are called ‘cells’, and each cell can contain a limited amount of information. The data $Q(\vec{x}, t)$ in each cell (\vec{x}, t) could be represented by an integer, or a set of integers, possibly but not necessarily limited by a maximal value \mathbb{N} . An evolution law prescribes the values of the cells at time $t + 1$ if the values at time t (or t and $t - 1$) are given. Typically, the evolution law for the data in a cell at the space-time position

$$(\vec{x}, t) \text{ , } \vec{x} = (x^1, x^2, \dots, x^d) \text{ , } x^i, t \in \mathbb{Z} \text{ ,} \quad (58.1)$$

will only depend on the data in neighbouring cells at $(\vec{x}', t - 1)$ and possibly those at $(\vec{x}', t - 2)$.”

The MCM exceeds ’t Hooft’s model in that the presence of a third derivative will require data at least as far back as $(\vec{x}', t - 3)$ due to the backward difference approximation of the third derivative. Retrocausality suggests data as far forward as $(\vec{x}', t + 3)$ as well, but those would make for tricky calculations since those data do not exist at time t . Overall, ’t Hooft’s cellular automaton is quite like the MCM. His insights on such physics are likely to provide clarifications on the structure of the MCM cosmological lattice. ’T Hooft’s lattice description raises an interesting question, actually, in that we have not decided if all non-local lattice sites contribute to local physics (as terms in a Laurent series, for example), or if we might restrict interactions with $|\psi; \hat{e}_\mu^k\rangle$ to $|\psi'_\lambda; \hat{e}_\nu^{k\pm n}\rangle$ for $0 \leq n \leq 3$. For comparison, the derivation of 10^{-4}m as the characteristic length scale for new effects referenced only one higher $\hat{\pi}$ -site and one lower one (Section 15).

’T Hooft explains the kernel of his model as follows [211].

“The price we do pay seems to be a modest one, but it needs to be mentioned: we have to select a very special set of mutually orthogonal states

in Hilbert space that are endowed with the status of being ‘real’. This set consists of the states the universe can ‘really’ be in. At all times, the universe chooses one of these states to be in, with probability 1, while all others carry probability 0. We call these states *ontological states*, and they form a special basis for Hilbert space, the ***ontological basis*** [*emphasis added*]. One could say that this is just wording, so this price we pay is affordable, but we will assume this very special basis to have special properties. What this does imply is that the quantum theories we end up with all form a very special subset of all quantum theories. This then, could lead to new physics, which is why we believe our approach will warrant attention: eventually, our aim is not just a reinterpretation of quantum mechanics, but the discovery of new tools for model building.”

Unfortunately, ’t Hooft’s book trails this writer’s “Ontological Physics” [71] by about five months. The main topic of that paper was that an observer has no way to tell if his *basis* for quantum mechanics is on one level of aleph or another.¹ One notes that the extensive reference to Bell’s theorem in ’t Hooft’s introduction follows “On Bell’s Inequality” [193] by that same five months. One might ask whether the comments in ’t Hooft’s introduction regarding the theory being “completely right, partly right, or dead wrong” refer respectively to the MCM model of particles [6], the framework for levels of aleph [71], and the proposed workaround for Bell’s inequality [193], all of which were published in 2013.² Whatever the circumstances, ’t Hooft’s program should be investigated. The following definitions from [211] are of particular interest.

“We plan to distinguish three types of operators:

- (I) *beables*: these denote a property of the ontological states, so that beables are diagonal in the ontological basis $\{|A\rangle, |B\rangle, \dots\}$ of Hilbert space:

$$\mathcal{O}_{\text{op}}|A\rangle = \mathcal{O}(A)|A\rangle \quad , \quad (\text{beable}) \quad . \quad (58.2)$$

- (II) *changeables*: operators that replace an ontological state by an-

¹The first verbatim appearance of the phrase “ontological basis” in the MCM is traced to 2015 [161]. It is possible that this writer had already had a look at ’t Hooft’s book when coining the term. However, the ontological basis cited in [161] was a clear continuation of the work regarding ontology and bases begun in [71]. The verbiage was probably found independently.

²As mentioned in Section 49, a number of unresolved conditions in the proposed workaround for Bell’s theorem [193], and further evidence for the non-locality of χ^4 suggest that the workaround may be infeasible, or “dead wrong.”

other ontological state, such as a permutation operator:

$$\mathcal{O}_{\text{op}}|A\rangle = |B\rangle \quad , \quad (\text{changeable}) \quad . \quad (58.3)$$

These operators act as pure permutations.

(III) *superimposables*: these map ontological states onto superpositions of ontological states:

$$\mathcal{O}_{\text{op}}|A\rangle = \lambda_1|A\rangle + \lambda_2|B\rangle + \dots \quad .” \quad (58.4)$$

To specify that which is of most interest, the time arrow states we have built from

$$\widehat{\text{MCM}}|\text{bounce}\rangle = |t_+\rangle + |t_-\rangle \quad , \quad (58.5)$$

cast $\widehat{\text{MCM}}$ as a “superimposable” operator.

59 Feynman’s Division of the Time Interval

In his spacetime approach to non-relativistic quantum mechanics, Feynman identifies a shortcoming of his framework [68]. After showing that the action

$$S[x(t)] = \int dt L(x(t), \dot{x}(t)) \quad , \quad (59.1)$$

can be divided into small steps along any path as

$$S = \sum S(x_i, x_{i-1}) \quad , \quad (59.2)$$

he writes the following [68].

“Actually, the sum in [(59.2)], even for finite [*time steps*] is infinite and hence meaningless (because of the infinite extent of time). This reflects a further incompleteness of the postulates. We shall have to restrict ourselves to a finite, but arbitrarily long, time interval.”

First, we have suggested that quantum equations of motion should differ from their classical counterparts when the action along a path is maximized rather than minimized (Section 1.5). Therefore, one might reformulate Feynman’s framework in that picture so as to avoid a *problem* of divergent action. Under fractional distance analysis, the sum in (59.2) will be proportional to $\widehat{\infty}$. One might also induce the

superposition time $|t_\star\rangle = |t_+\rangle + |t_-\rangle$ so that the integral over t in (59.1) yields one negative action increment for every positive one so that the sum of small increments should converge in the neighborhood of the origin. As the action of two different paths through time, the corresponding equations of motion would describe two systems, one of which might be taken as Feynman's. One might develop a system for superpositions of motion following from the superposition of time. Ultimately, this would be linked to the metric's definition as a sum of contributions from Σ^\pm .

60 Path Integrals

The path integral measure

$$\int Dq(t) \equiv \lim_{N \rightarrow \infty} \left(\frac{-im}{2\pi\delta t} \right)^{\frac{N}{2}} \left(\prod_{k=1}^{N-1} \int dq_k \right) , \quad (60.1)$$

represents an infinite-dimensional integral whose place in physics is not supported by the highest level of mathematical rigor, yet it is used to compute amplitudes in the form

$$\langle \psi_2 | e^{-i\hat{H}T} | \psi_1 \rangle = \int Dq(t) \exp \left\{ i \int_0^t dt' \frac{1}{2} m \dot{q}_k^2 \right\} . \quad (60.2)$$

The integral over the oscillating complex exponential function in (60.2) cannot be guaranteed to converge, so, in general, one substitutes a complex integration variable $-it'$ for the real variable t' to obtain an exponentially damped integral which is known to converge. Since substitutions of the form $\mathbb{R} \rightarrow \mathbb{C}$ are still non-rigorous (under a certain standard of rigor), one would seek to employ the many methods for complex time listed in the previous sections to reformulate the path integral in an absolutely convergent form from physical considerations alone without the need to introduce an additional analytical step $t \rightarrow -it$, commonly called Wick rotation. The desire to obtain an effective Wick rotation for (60.2) would guide the choice of phase convention among the various steps of \hat{M}^3 .

61 The Golden Ratio in Black Holes

The factor of 2π inherent to

$$\hat{M}^3 |\psi, \hat{\pi}^0\rangle = 2\pi \Phi |\psi, \hat{\pi}^1\rangle , \quad (61.1)$$

is ordinary in physics, but the coefficient's proportionality to Φ is eccentric. The

golden ratio is not encountered very often in physics. One of the few places where it may be found is in the thermodynamics of black holes [214–218].¹ Since we expect to accrue powers of Φ in the MCM by successive transmissions through a black hole at each \emptyset -brane separating successive levels of aleph, a study of the black hole context for Φ is in order. In [214, 215], Davies has shown that the specific heat of a black hole transitions from negative to positive when a certain ratio exceeds the golden ratio (under certain conditions.) The transition between positive and negative specific heat evokes the picture of changing time arrow direction at the Ω -brane where $\chi_+^4 = \Phi$. Furthermore, Cruz, Olivares, and Villanueva have found that Φ is associated with the turning points of orbits around certain black holes [216]. Thus, a deep study of black holes and their thermodynamics is in order.

62 Rydberg States

Rydberg states are highly excited atomic bound states near the ionization energy. One of the least understood areas of atomic physics regards the structure of the Hamiltonian near the ionization energy. Below it, the Hamiltonian is represented as a diagonal matrix with a countable infinity of energy eigenvalues written as its diagonal entries. Beyond countable infinity, however, the infinite discrete bound states $|n\rangle$ give way to a continuum of free particle states which cannot be enumerated with integers. The Hamiltonian can no longer be represented as a true matrix above this energy, but quantum theory provides little to no guidance on the transition from matrix-valued Hamiltonians to ones with continuous analogues of rows and columns.

Numbers in the neighborhood of infinity are well suited to the study of the transition from bound states to free particle states at the ionization energy. One might limit the number of atomic bound states by an appeal the Planck scale, but the mathematical structure of the theory is such that for any $n, m \in \mathbb{N}$ with $m > n$, there are an infinite number of E_m such that $E_n < E_m < E_{\text{ion}}$. With n confined to the neighborhood of the origin, it is not possible, in terms of the quantum number $|n\rangle$, even to begin to approach a state in the region of anomalous transition from discrete to continuous energy eigenvalues. The arithmetic of $\widehat{\infty}$, however, should allow us to write down the highest energy bound state as $|\widehat{\infty} - 1\rangle$. In turn, this may facilitate new methods for investigating the transition from bound states to free particle states and thereby illuminate a nebulous region of quantum theory.

¹In [219], Xu and Zhong report obtaining Φ in QM. A reference therein to El-Naschie’s E-infinity theory [220] puts the result of [219] in scope for the MCM because α_{MCM} was first obtained in 2011 following the program of El-Naschie in [221].

63 Two Time Models

The MCM is much like a two time model such as those described by Bars et al. [222–226]. Bars writes the following [223].

“The physics that is traditionally formulated in one-time-physics (1T-physics) can also be formulated in two-time-physics (2T-physics). The physical phenomena in 1T or 2T physics are not different, but the spacetime formalism used to describe them is. The 2T description involves two extra dimensions (one time and one space), is more symmetric, and makes manifest many hidden features of 1T-physics. One such hidden feature is that families of apparently different 1T-dynamical systems in d dimensions holographically describe the same 2T system in $d+2$ dimensions.”

Similarly, the MCM adds one spacelike and one timelike dimension as χ_{\pm}^4 to establish a system of holographic duality between boundary physics in \mathcal{H} and bulk physics in Σ^{\pm} . Therefore, one would conduct a survey of 2T models and phrase the MCM in those terms.

64 Time and Imaginary Time

Regarding the spacelikeness and timelikeness of χ_{\pm}^4 , one would undertake considerations regarding duality between time in QFT and imaginary time in statistical mechanics. Creutz and Freedman write the following [227].

“Feynman’s path integral formulation of quantum mechanics reveals a deep connection between classical statistical mechanics and quantum theory. Indeed, in an imaginary time formalism the Feynman integral is mathematically equivalent to a partition function.”

Like the duality between a Feynman diagram and the MCM model of dual universes, *and* like the AdS/CFT correspondence, this “deep connection” between the path integral and the partition function is exciting despite any clear understanding of what the connection is. Following the program to obtain the $\{- + + +\}$ signature of Minkowski space from $x^0 = ict$, the $\{- + + + \pm\}$ signature in Σ^{\pm} implies that there must exist an imaginary phase between χ_{\pm}^4 relative to some affine parameter. If one is like time, the other is like imaginary time. In terms of the metric signature which results from this relative phase, they are spacelike and timelike, so the imaginary time representation will give us cause to treat both of χ_{\pm}^4 like time, regardless of the phase.

The spacelikeness of one or the other of χ_{\pm}^4 was mentioned in previous sections as a potential impediment to equations for time-parameterized motion across the unit cell, but the imaginary time provides a convenient workaround.

The extensive body of literature detailing the connections between time in QFT and imaginary time in statistical mechanics, including $t \rightarrow -it$ Wick rotations, should provide valuable insights into the structure of the unit cell and its cosmological lattice.

65 String Theory

A survey of string theory is in order! Particularly, the new holographic duality between the surface \mathcal{H} and the bulk spaces Σ^{\pm} should be associated, to the degree that it is possible, with the AdS/CFT correspondence [59] whose context in string theory is well studied in a large body of literature. As a first jump into string theory for the MCM, consider Zwiebach’s remarks in [228].

“Despite the large number of particles it describes, the Standard Model is reasonably elegant and very powerful. As a complete theory of physics, however, it has two significant shortcomings. The first one is that it does not include gravity. The second one is that it has about twenty parameters that cannot be calculated within its framework. Perhaps the simplest example of such a parameter is the dimensionless (or unit-less) ratio of the mass of the muon to the mass of the electron. The value of this ratio is about 207, and it must be put into the model by hand. [...] The first sign that string theory is rather unique is that it does not have adjustable dimensionless parameters. As we mentioned before, the Standard Model of particle physics has about twenty parameters that must be adjusted to some precise values. A theory with adjustable dimensionless parameters is not really unique. When the parameters are set to different values one obtains different theories with potentially different predictions. String theory has one dimensionful parameter, the string length ℓ_s . Its value can be roughly imagined as the typical size of strings.”

One would begin a foray into the exciting field of string theory by supposing that the lengths of strings or the dimensionless ratios of strings’ lengths should be proportional to the numbers in the ontological basis.¹ The S-, T-, and U-dualities of string theory should be contextualized as dualities inherent to the unit cell and the

¹In a video lecture series on string theory, Susskind supposes that there might exist a string of length π before *greatly demurring* regarding the origin of that idea. Unfortunately, this lecture series appears to have been deleted from the internet, and a citation cannot be offered.

cosmological lattice spanning various levels of aleph. Not strangely, the dimensionality of famous 10- and 26-dimensional string theories, and 11D M-theory, is natural in the unit cell. The two 5D theories in Σ^\pm give ten dimensions and adding x^0 makes 11. Counting

$$\chi_+^A, \chi_-^A, x_+^\mu, x_-^\mu, x^\mu, \text{ and } \chi_\emptyset^\mu, \quad (65.1)$$

shows 26 degrees of freedom when Ω and \mathcal{A} are not separated by a 5-space, i.e.: when $\chi_\emptyset \neq \chi_\emptyset^A$. One would establish a link between 10- and 26D string theories by noting that the coordinates in the bounding branes should be determined by holographic duality with the coordinates in Σ^\pm .

Sen has theorized a process in string theory called *tachyon condensation* which is likely to have applications toward the MCM [229]. The superluminal quality of tachyons is directly applicable to a model of χ^A as a non-local variable: one whose information and correlations are not restricted by the speed of light, as in Section 49. Furthermore, the thermodynamic process of condensation should introduce an equation of state which the MCM has so far ignored. Such physics may make it possible to describe the change of basis operation between chirological and chronological time arrow states as a thermodynamic phase transition from propagation in the bulk of Σ^\pm to confinement in \mathcal{H} .

66 Fast Radio Bursts

This problem resides in the MCM's early venue: cosmological phenomenology. It is suggested that fast radio bursts [230,231] should be modeled as black hole lightning. Petroff, Hessels, and Lorimer write the following [231].

“[P]ulsar surveys have led to the serendipitous discovery of fast radio bursts (FRBs.) While FRBs appear similar to the individual pulses from pulsars, their large dispersive delays suggest that they originate from far outside the Milky Way and hence are many orders-of-magnitude more luminous. While most FRBs appear to be one-off, perhaps cataclysmic events, two sources are now known to repeat and thus clearly have a longer-lived central engine. [...] With peak flux densities of approximately 1 Jy, this implied an isotropic energy of 1032 J (1039 erg) in a few milliseconds or a total power of 1035 J s⁻¹ (1042 erg s⁻¹.) The implied energies of these new FRBs were within a few orders of magnitude of those estimated for prompt emission from GRBs and supernova explosions, thereby leading to theories of cataclysmic and extreme progenitor mechanisms. [...] Currently, the

research community has no strict and standard formalism for defining an FRB, although attempts to formalize FRB classification are ongoing [...]. In practice, we identify a signal as an FRB if it matches a set of loosely defined criteria. These criteria include the pulse duration, brightness, and broadbandedness, and in particular whether the [*dispersion measure*] is larger than expected for a Galactic source.”

The dynamical origin of large-scale charge distributions leading to terrestrial lightning are not understood. EM theory suggests that large-scale charge formations should not appear in the atmosphere because they would seem to neutralize themselves at small-scale. However, lightning is known to occur on a scale which is only possible given unexplained large-scale charge distributions. It is also known that lightning is a radio source. Therefore, one might suppose that the mechanism for the anomalous assembly of large-scale charge distributions between a planet and its atmosphere is also in play between a black hole and its accretion matter. The famous no-hair theorem (which is a conjecture) permits black holes to have only three observable parameters, one of which is electric charge. In the absence of a dense atmosphere, the amount of charge needed to induce dielectric breakdown in the local neighborhood of a black hole is expected to be very large. Therefore, it is reasonable to suppose that “cataclysmic” and “one-off” FRB events are black hole lightning. Dielectric breakdown of accretion matter is one possible mechanism. Dielectric breakdown of the quantum vacuum is an exotic mechanism which might be investigated.

As a work in phenomenology, one would assemble known radio models of terrestrial lightning and then compute the characteristics of black hole lightning needed to produce the observed radio fluxes at cosmological distances. A few known repeating FRB sources may be understood as black hole lightning storms. Planetary storm clouds are known not to totally discharge in single lightning bolts, so some constraint mechanism would be introduced to explain the possible incomplete electric discharge of a black hole upon a single FRB event.

Appendix A: The Origin of \hat{M}^3

The original motivation for \hat{M}^3 was only a requirement for some third order operator needed to generate the $(\Phi\pi)^3$ term appearing in $\alpha_{\text{MCM}}^{-1} = (\Phi\pi)^3 + 2\pi$. However, the third order operator became independently useful, as in Section 1 and elsewhere. For breadth, this appendix will fully review the original development of \hat{M}^3 in which it was conceived only as a way to force a cubed term into a theory where cubed terms usually do not appear. The first statement of \hat{M}^3 appeared in [30]. This was published before the construction of the unit cell [7] whose structure provides the current best framework for understanding \hat{M}^3 .

What follows is the first statement of requirements for \hat{M}^3 , as given in [30]. For consistency with present notations, the original symbol \aleph from [30] is replaced with \mathcal{A} . Following the excerpt, we will carefully review what was written.

“If the observer’s proper time is t_0 [,] we can write the following with certainty.

$$\begin{aligned} \text{Past} &:= [t_{\min}, t_0) \\ \text{Present} &:= [t_0] \\ \text{Future} &:= (t_0, t_{\max}] \ . \end{aligned} \tag{A.1}$$

“In General Relativity there is no inertial frame[,] but one is assumed[,] and L^2 is the vector space of this approximation. Unitary evolution [*of charged particles*] in this space is characterized by orders of [*the fine structure constant*]. This number should be a direct prediction of a complete Quantum Theory. A finely structured theory is needed, one which does not reside in the Hilbert space \mathcal{H} alone. To be precise, define a Gelfand triple $\{\mathcal{A}, \mathcal{H}, \Omega\}$ where each set contains a Minkowski picture \mathbf{S} .

$$\begin{aligned} \mathcal{A} &= \{x_-^\mu \in \mathbf{S} \mid t_{\min} < t < t_0\} \\ \mathcal{H} &= \{x^\mu \in \mathbf{S} \mid t = t_0\} \\ \Omega &= \{x_+^\mu \in \mathbf{S} \mid t_0 < t \leq t_{\max}\} \ . \end{aligned} \tag{A.2}$$

“The Minkowski diagram gives a clear illustration. The past and future light cones define the half spaces \mathcal{A} and Ω [,] and the hypersurface of the present is a delta function $\delta(t - t_0)$. The present is defined according to the observer[,] so it is an axiom of this interpretation that the observer is

isomorphic to the δ function. Our task is how to reconcile calculations in \mathcal{H} with the actual dynamics of Nature proceeding around us and through us in \aleph and Ω . To this end[,] define an operator \hat{M}^3 that is non-unitary and complimentary to the unitary evolution operator \hat{U} .

$$\begin{aligned} \hat{U} : \mathcal{H} &\mapsto \mathcal{H} & \text{and} & & \hat{M}^3 : \mathcal{H} &\mapsto \Omega \mapsto \mathcal{A} \mapsto \mathcal{H} & \quad (\text{A.3}) \\ \hat{U} &:= \partial_x \quad , & & & \hat{M}^3 &:= \partial_t \quad . \end{aligned}$$

The above appeared in [30] only as a segue into the main result of the short paper titled “Derivation of the Fine Structure Constant.” While terse brevity is a hallmark of an academic writing style, the brevity of the segue has been cited as rendering the entire paper nonsensical. The purpose of this appendix is, in part, to refute such claims. To that end, the reader is encouraged to understand that these few words above, excerpted from the beginning of [30], were written only to introduce the main result that $(\Phi\pi)^3 + 2\pi \approx 137$ very nearly replicates the accepted value for α_{QED}^{-1} . This result does not hinge on any of the material quoted above, yet detractors cite the abrupt progression through the introduction as if it nullifies the main result of the paper whose title is as stated: derivation of the fine structure constant.

The second sentence of the excerpt about the assumption of inertial frames means that although flat space does not exist, it is assumed to exist. The L^2 space of position space wavefunctions is usually assumed on a flat spacetime background. One does quantum mechanics in an implicit Lorentz frame, even if general relativity is not considered. In QED, a relativistic extension of quantum mechanics, α characterizes the interaction between photons and charged particles. Various generating functionals for amplitudes of processes involving charged particles may be decomposed as power series in α . The unitary evolution of such particles is foremost among those things which are described with quantum theory, as in the excerpt’s third sentence. The main purpose of these remarks is not to derive the FSC. Instead, they are a segue into what would otherwise be a single line reporting the paper’s main result: $(\Phi\pi)^3 + 2\pi \approx 137$ may be of interest to those who wonder about where α comes from.

Dirac said finding the origin of this number is, “the most important unsolved problem in physics,” and Feynman wrote the following [87].

“It is a simple number that has been experimentally determined to be close to 0.08542455. (My physicist friends won’t recognize this number, because they like to remember it as the inverse of its square: about 137.03597 with about an uncertainty of about 2 in the last decimal place. It has been a mystery ever since it was discovered more than fifty years ago, and all good

theoretical physicists put this number up on their wall and worry about it.) Immediately you would like to know where this number for a coupling comes from: *is it related to pi* [*emphasis added*] or perhaps to the base of natural logarithms? Nobody knows. It's one of the greatest damn mysteries of physics: a magic number that comes to us with no understanding by man. You might say the 'hand of God' wrote that number, and 'we don't know how He pushed his pencil.' We know what kind of a dance to do experimentally to measure this number very accurately, but we don't know what kind of dance to do on the computer to make this number come out, without putting it in secretly!"

While all good physicists worry about this number whose origin *may be related to* π , many readers of [30] expressed no interest in it, preferring instead to fixate on a few of the tangential introductory remarks. The main purpose of [30] was to demonstrate that a certain "dance" with a third order operator does the trick quite nicely. At the end of the paper, it was suggested that if this dance is real and not wrongly contrived, then there should exist observables correlated with delay. The main point of the paper, however, was to report that there exists a previously unconsidered type of dance which outputs the requisite number to within an accuracy that can probably be reconciled via theoretical restructuring, as in Section 1.9.

As is usual in physics, there was a segue giving some context at the beginning of the paper. As is not usual in physics, detractors cite the segue as if it was something other than a few brief words given for context.¹ Furthermore, the delay experiment which was suggested to support the context returned an affirmative confirmation [32]. If the experimental prediction had not been confirmed, the paper's main result would have stood on its own: $(\Phi\pi)^3 + 2\pi$ might be of interest to those interested in the "most important unsolved problem in physics."

The next item in the excerpt regards the introduction of rigged Hilbert space. The reasons for doing quantum theory in rigged Hilbert space are well known. For instance, de la Madrid writes the following [60].

"Nowadays, there is a growing consensus that the [*rigged Hilbert space*], rather than the Hilbert space alone, is the natural mathematical setting of Quantum Mechanics."

¹A certain formula for the Riemann ζ function was given at the beginning of [49] wherein the architecture of the neighborhood of infinity and an eventual formal negation of the Riemann hypothesis were developed. Many readers of [49] fixated on the lack of a caveat clarifying that the formula was not defined everywhere on the complex plane while completely ignoring the paper's main result. Then, as in [30], the limitation on the domain of validity for that formula had absolutely no impact on the paper's topic or main results. It is not required to reinvent the wheel each time a scientific paper is written, and the formula was presented only to sketch a setting for the main result.

Nothing new about rigged Hilbert space is written in [30]. Position eigenstates don't exist in Hilbert space, but definite location at a point in Minkowski space \mathbf{S} can only be represented in quantum theory with a position eigenstate. Since one uses such eigenstates (and similar) very often in the course of doing quantum mechanics, one would adopt a state space which does not preclude their existence.

One valid criticism of [30] regards a notational deficiency. We fail to distinguish with separate labels the state spaces in the RHS from the subsets of \mathbf{S} identified with the past, present, and future. This deficiency has been remedied in subsequent work with the addition of a tick mark to distinguish $\{\mathcal{A}', \mathcal{H}', \Omega'\}$ from the manifolds \mathcal{A} , \mathcal{H} , and Ω . In [30], it is clear that $\{\mathcal{A}, \mathcal{H}, \Omega\}$ is a rigged Hilbert space, and it is clear that the given \mathcal{A} , \mathcal{H} , and Ω are subsets of Minkowski space. However, the non-ticked notation relies on the reader's ability to differentiate between state spaces and geometric manifolds. The statement that each set (a state space is a set of vectors equipped with an inner product) contains a Minkowski picture is imprecise. The state spaces are said to contain the coordinate spaces because the coordinate spaces are the domains of the functions which represent the states. It might have been stated more clearly that if ψ is a function of $x_-^i \in \mathcal{A}$, then $\psi \in \mathcal{A}'$. Still, the paper's main result was that a third order operator can output the value $(\Phi\pi)^3$ required for α_{MCM} , and that observed delay correlations would lend further support to the way \hat{M}^3 was hypothesized. The distinction of the domain of each function space was not very important for the main result, and the detail was glossed over.

Moving on to the next item in the excerpt, the hypersurface of the present is *given by* $\delta(t - t_0)$, as per usual. Some readers of [30] insist that they cannot, could not, or would not understand the obvious relationship between the Dirac δ function and a surface selected from a bulk. It is claimed that the absence of further words such as "given by" overwhelmed and destroyed their knowledge of the only possible relationship between a δ function and a surface. Regarding the usual ability of a scientific reader to infer, consider the definition of the Dirac δ function published by Proceedings of the Royal Society of London in 1927 [232].

"One cannot go far in the development of the theory of matrices with continuous ranges of rows and columns without a notation for that function of a c-number x that is equal to zero except when x is very small, and whose integral through a range that contains the point $x=0$ is equal to unity. We shall use the symbol $\delta(x)$ to denote this function, i.e.: $\delta(x)$ is defined by

$$\delta(x) = 0 \quad , \quad \text{with} \quad x \neq 0 \quad , \quad (\text{A.4})$$

and

$$\int_{-\infty}^{\infty} x \delta(x) = 1 \quad .” \tag{A.5}$$

None of Dirac’s readers reached this definition and stopped with a declaration, “This is nonsense! Matrices have discrete rows by construction, so there is no such thing as a matrix with continuous rows.” None stopped reading and put Dirac’s paper into the trash declaring, “The integral symbol only has meaning when it appears with the differential of an integration variable such as dx . Clearly this fool Dirac, who does not understand even the most basic principles of calculus, is wasting pages in the journal where I have found his paper!” It is suggested that the main difference by which Dirac’s readers were able to infer a dx in the integral over $\delta(x)$, while others were not able to infer the relationship between a δ function and a surface, is that Dirac’s readers were reading with an intention to understand while others were reading about the MCM with an intention not to understand, and to say that the MCM is worthless, and that the author is a poor pretender, or worse.

The hypersurface of the present is given by a δ function in the way that one might select the volume V of all of space from the volume VT of all of spacetime. One inserts $\delta(t - t_0)$ into $\int d^4x$. The selection of such surfaces by δ functions is standard, and this is what was meant in [30] when it was said that the hypersurface of the present *is* a δ function, rather than that it *is given by* one. What we usually do with the hypersurface of the present in QM is to integrate over all of it with d^3x , and quantum mechanics usually ignores d^4x . However, the *dance* prescribed in [30] is such that we need to differentiate among the d^3x at various x^0 . The intended readership for [30] was assumed to have some familiarity with the physicist’s basic mathematical toolbox, but many detractors have admitted no such familiarity. While it is true that the surface is not the δ function itself identically, the reader is given a choice by the brevity. They may understand the relationship between surfaces and δ ’s, or they may choose not to. Furthermore, the hypersurface of the present being given by a δ function has almost nothing to do with the paper’s main result. It is only mentioned to compare the present moment’s quality of singular thinness to the extended bulk of the past and future, and to complement, thereby, the stated division of

$$\text{Past} := [t_{\min}, t_0) \quad , \quad \text{Present} := [t_0] \quad , \quad \text{and} \quad \text{Future} := (t_0, t_{\max}] \quad . \tag{A.6}$$

The observer is said to be *isomorphic* to the δ because the δ that selects the hypersurface of the present is comoving in spacetime with the observer. If the observer’s proper time is t_{now} , that shows up in the stated mechanism as $\delta(t - t_{\text{now}})$. Isomorphic means “corresponding or similar in form and relations,” and the association of the

observer at proper time t_{now} with $\delta(t - t_{\text{now}})$ is exactly that.

Now we have worked through the *introductory remarks* in [30]. The remainder of the excerpt proposes the \hat{M}^3 operator whose non-unitarity and functioning are discussed in Section 1 of the present paper. After briefly explaining the relationships among $\{\mathcal{A}, \mathcal{H}, \Omega\}$, the mathematical property of \hat{M}^3 was stated as

$$\hat{M}^3 : \mathcal{H}'_1 \rightarrow \Omega' \rightarrow \mathcal{A}' \rightarrow \mathcal{H}'_2 \quad . \quad (\text{A.7})$$

It was suggested that the mechanism proposed for \hat{M}^3 would result in observable delay correlations, and these were observed in the BaBar data forthwith [32]. The fixation of detractors on the terseness of [30] belies a low comprehension if not a malicious intent to wrongfully naysay. A positive reader should have come away with the understanding that α_{MCM}^{-1} can be extracted from some rather ordinary quantum mechanical formalism, that α_{MCM}^{-1} and α_{QED}^{-1} differ by about 0.4%, and that observed delay correlations were expected to serve as experimental support. In the remainder of this appendix, we will continue a critical review of [30], and the intention will be to address all possible criticisms that a non-positive or overly pedantic reader might seize upon in lieu of the main results.

To contextualize the FSC result itself, first consider that the MCM is such that the universe is like a quantum particle. Since the universe contains smaller quantum particles of its own, an apparent scale invariance and self-similarity in the model directed this writer's attention toward fractal models of cosmology. Coming quickly to the prolific body of work due to El Naschie, a formula was encountered for the fractal dimension of a Cantorian spacetime [221]:

$$D = 4 + \varphi^3 \quad , \quad \text{where} \quad \varphi = \frac{|1 - \sqrt{5}|}{2} \quad . \quad (\text{A.8})$$

This formula profoundly attracted this writer's attention, as described in [96]. The formula

$$\alpha_{\text{MCM}}^{-1} = 2\pi + (\Phi\pi)^3 \approx 137 \quad , \quad (\text{A.9})$$

was quickly obtained by the ansatz method. The example of the 2D box given in [30] was devised to support an explanation for where such a number might come from. The sides of the box—a duration D and a length L —were chosen to satisfy $\Phi D = 2L$. Written as $D = 2\varphi L$, this is in the same general form of $C = 2\pi R$ giving the circumference of a circle in terms of the radius.¹ This is somewhat interesting as

¹In Section 1.2.4, we assumed that \mathcal{H} was spanned by one unit of time so that we could use the locations of \mathcal{A} and Ω at $\chi_-^4 = -\varphi$ and $\chi_+^4 = \Phi$ to identify the unit cell with a pair of golden rectangles of dimensions $\Phi \times 1$ and $1 \times \varphi$.

a geometric confluence, and it was stated as such in [30]. However, it went unstated that (A.9) was conceived as a *circularization* of the *rectangular* (A.8), meaning $4 \rightarrow 2\pi$ and $\phi^3 \rightarrow (\Phi\pi)^3$. In that way, in the context of the author's thinking, the confluence of the dimensions of the 2D box mimicking $C = 2\pi R$ was slightly more significant than what was recorded in [30].

The inclusion of t for one of the sides of the box was a hard concept because t is only used for time evolution in quantum mechanics. States in Hilbert space do not depend on t as they do the x associated with the L side of the box. However, the subsequent introduction of the χ^4 variables as a second form of time sidesteps the problem of double usage for t . The 2D box was eventually replaced by the unit cell, and the box spanned by space and time later became important for the MCM particle scheme, as in Section 0.3 and [6]. Still, the general idea for an operator on a state in a box which should return α_{MCM}^{-1} as a characteristic value remains as it was, as in Section 1.9.

Continuing with a review of the material in [30], the well-known wavefunction of a particle in a 2D box with sides D and L is

$$\psi_{nm}(x, t) = \frac{2}{\sqrt{DL}} \sin\left(\frac{n\pi x}{L}\right) \sin\left(\frac{m\pi t}{D}\right) . \quad (\text{A.10})$$

A box spanned by one dimension of space and one dimension of time is a 2D universe, so putting the particle in this box was like putting it into a finite model of the universe. Likewise, one of the main purposes of the modern unit cell is to put a universe, possibly even a universe extending infinitely far in its physical coordinates, inside an abstract box of finite dimension. Having fixed the box' aspect ratio $D = 2\varphi L$ in [30], the duration was set to φ . The chosen dimensions are such that

$$\psi_{nm}(x, t) = 2\sqrt{2\Phi} \sin(2n\pi x) \sin(\Phi m\pi t) . \quad (\text{A.11})$$

This is not a simultaneous eigenvector of ∂_x and ∂_t^3 as would be required for equation (19) in [30]:

$$\hat{\Upsilon}\psi_{11} = (\partial_x + \partial_t^3)\psi_{11} = \alpha_{\text{MCM}}^{-1} \psi_{11} , \quad (\text{A.12})$$

where $\hat{\Upsilon} = \partial_x + \partial_t^3$ reflects $\hat{\mathcal{U}} := \partial_x$ and $\hat{M} := \partial_t$. Instead, these partial derivatives operate on (A.11) as

$$\partial_x \psi_{11}(x, t) = 2\pi\phi_1(x, t) , \quad \text{and} \quad \partial_t^3 \psi_{11}(x, t) = (\Phi\pi)^3 \phi_2(x, t) , \quad (\text{A.13})$$

However, x^0 rightfully spans infinitely far into the past and infinitely far into future, so we would assume that the length of the \mathcal{H} -brane in the x^0 direction is 2∞ . Assuming that the chronological and chirological coordinates are on different levels of aleph scaled by ∞ , $D = 2\infty$ in \mathcal{H} and $L = \Phi\infty$ in Σ^+ satisfy the ratio $D = 2\varphi L$.

where ϕ_1 and ϕ_2 demonstrate that ψ_{11} is incompatible with the eigenvalue equation in (A.12). The exponential, not the sine, is the eigenfunction of the derivative. Since α^{-1} is observable, quantum theory suggests that it should be an eigenvalue of an operator's eigenvector, but this detail was neglected in [30].

The equation $\hat{\Upsilon} = \hat{\mathcal{U}} + \hat{M}^3$ was written in [30], but we have used it as $\hat{\Upsilon} = \partial_x + \partial_t^3$. This could have been better clarified. The statement $\hat{\mathcal{U}} := \partial_x$ refers to

$$\hat{\mathcal{U}}(t, t_0) = \exp\left\{\frac{-i\hat{H}(t-t_0)}{\hbar}\right\} = \exp\left\{\frac{-i(t-t_0)}{\hbar}\left[\frac{\hat{p}^2}{2m} + \hat{V}(\hat{x})\right]\right\},^1 \quad (\text{A.14})$$

wherein \hat{H} depends on $\hat{p} \propto \partial_x$. To get 2π out of ψ as needed for $2\pi + (\Phi\pi)^3$, we have operated with ∂_x . Since $\hat{\mathcal{U}}$ uses $e^{\partial_x^2}$, there would be an implicit square root somewhere, and a logarithm would be required to use $\hat{\mathcal{U}}$ for returning 2π . For instance, equations (7) and (8) in [30] were

$$\begin{aligned} \hat{\mathcal{U}}|\psi\rangle &:= \partial_x(2n\pi x) = 2n\pi & (\text{A.15}) \\ \hat{M}|\psi\rangle &:= \partial_t(\Phi m\pi t) = \Phi m\pi, \end{aligned}$$

but the time evolution operator $\hat{\mathcal{U}}$ (given a time-independent Hamiltonian and an energy eigenstate ψ_E) is such that

$$\hat{\mathcal{U}}|\psi_E\rangle = e^{-iEt/\hbar}|\psi_E\rangle. \quad (\text{A.16})$$

The $:=$ symbol has been used in [30] to suppress the fact that the value for α_{MCM}^{-1} would probably appear as an exponent. As [30] is written, all such details pertaining to an exact arithmetic are relegated to the catch-all $:=$ symbol. However, the hard functioning of **the main result** is given by the strict equality

$$\alpha_{\text{MCM}}^{-1} = 2\pi + (\Phi\pi)^3. \quad (\text{A.17})$$

The context of the 2D box was reverse engineered to fit this result. Similarly, Schrödinger's initial publication of his equation [81] gave its context as being derived from the stationary action principle. That reasoning for coming to the Schrödinger equation has not stood the test of time even while the equation itself has survived. Likewise, the context of the 2D box proffered in [30] is no longer an attractive path toward arriving at the equation for α_{MCM}^{-1} . Even then, the box is important for this appendix.

The operator $\hat{\Upsilon}$ in (A.12) requires a simultaneous eigenfunction of ∂_x and ∂_t^3 , and

¹This form of $\hat{\mathcal{U}}$ is developed in Appendix B.

one such function is

$$\Psi_{nm}(x, t) = Ae^{i\pi(2nx + \Phi mt)} \quad . \quad (\text{A.18})$$

Ψ_{nm} would be obtained by rescaling x and t to be small relative to the dimensions of the box. Far from the edges of the universe-as-a-box, the solutions are plane waves in an ordinary way of approximating physics.¹ In this case, one might have simply supposed plane waves with the given wavenumber and frequency without invoking the context of a box at all. It is true that free particle plane wave solutions are essentially the opposite of particle-in-a-box solutions (Section 1.7.3), but it also true that plane waves in the universe are ultimately constrained to be particle in a box states due to the L^2 condition of square integrability.² In any case, observable operators have real-valued eigenvalues, and (A.18) does the trick with operators $-i\partial_x$ and $-i\partial_t^3$:

$$\hat{Y} = -i(\partial_x + \partial_t^3) \quad \implies \quad \hat{Y}\Psi_{11} = \left[2\pi + (\Phi\pi)^3\right] \Psi_{11} \quad . \quad (\text{A.19})$$

Overall, the heavy reliance on the $:=$ symbol in [30] was purposed to avoid tangential details. The unstated point in presenting the 2D box was that it was reasonable to expect that a sufficient eigenstate should exist due to the low algebraic complexity of the formula for α_{MCM}^{-1} . Noting that even the inclusion of this present paragraph would have increased the word count of [30] by 10% or so, certain details were omitted. To facilitate the structure of the paper, a *toy model* was constructed wherein one obtains α_{MCM}^{-1} as the eigenvalue of an operator. In hindsight, it may have been better to directly suppose the plane waves in (A.18) than to try to extract the geometric setting of a box. On the other hand, the initial ideation for a box led to the box-like structure of the MCM unit cell which has been useful for continued inquiry.

Regarding the excerpt below, non-standard language around (A.20), (A.21), and (A.22) also deserves attention.

“We have defined a unitary time evolution operator and a non-unitary one. Assume the correct evolution operator is the sum of a unitary part

¹Confinement to a finite volume induces quantization on a state’s wavenumber, but for applications in which the wavelength is much smaller than the dimension of the box, which is also called being *far from the edges*, one often ignores the quantization to suppose that the state has a continuous wavenumber and extends infinitely far. This approximation is generally valid when the range of wavenumbers considered is such that the wavelength is everywhere small compared to the confinement dimension, *and* when the region under consideration is far from the edges of the box. For visualization purposes, one understands that increasing the quantum number on a particle-in-a-box state adds maxima to the sinusoidal wavefunction. When the number of maxima is very large, it is often safe to assume that the quantum number becomes continuous. It is also safe to ignore the non-plane wave boundary condition that the states must vanish at the edges of the box if one is considering a region where the wavefunction is separated from the boundary by a large number of local maxima. Thus, one assumes plane waves in an ordinary way of approximating physics.

²This case for assuming plane waves follows the conditions in the previous footnote. The universe is large compared to a typical de Broglie wavelength.

and a non-unitary part so that $\hat{\Upsilon} = \hat{\mathcal{U}} + \hat{M}^3$

$$\langle \psi; x, t | \hat{\Upsilon} | \psi; x, t \rangle = \langle \psi; x, t | \hat{\mathcal{U}} | \psi; x, t \rangle + \langle \psi; x, t | \hat{M}^3 | \psi; x, t \rangle \quad (\text{A.20})$$

$$\langle \psi | \hat{M}^3 | \psi \rangle := \int \psi^*(t) \delta(t) \partial_t^3 \psi(t) dt \quad , \quad (\text{A.21})$$

[w]here the inclusion of $\delta(t)$ fixes the observer at $[t=0]$. The integral over all times will trace a path through \mathcal{A} , \mathcal{H} , and Ω . To use the integrand $f(t)\delta(t)[,]$ we must employ the familiar method from complex analysis.

$$\int_{-\infty}^{\infty} \delta(t) f(t) dt = \int_0^{t_{\max}} f(r, 0) dt + \int_0^{\pi} f(\infty, \phi) d\phi + \int_{t_{\min}}^0 f(r, \pi) dt \quad . \quad (\text{A.22})$$

This method is an outstanding logical proxy for the process [*Present*→*Future*→*Past*→*Present*].”

The usual definition for an expectation value is

$$\langle \hat{Q} \rangle = \int d^3x \psi^*(\mathbf{x}) \hat{Q} \psi(\mathbf{x}) \quad , \quad (\text{A.23})$$

but the excerpt contains

$$\langle \hat{M}^3 \rangle := \int dt \psi^*(t) \delta(t) \partial_t^3 \psi(t) \quad . \quad (\text{A.24})$$

Keeping in mind that t has been replaced with χ^4 in subsequent work, the purpose of this non-standard definition of the expectation value was to induce the piecewise structure on t which is now found in $\{\chi_+^4, \chi_-^4, \chi_{\emptyset}^4\}$. The $:=$ symbol is used in (A.24) to highlight only the new MCM part of the integral while ignoring the spatial part that should take its usual form, as in (A.23). If the $\delta(t)$ appearing in (A.24) is the Dirac δ function, we obtain

$$\langle M^3 \rangle := (\Phi\pi)^3 \int dt \psi_{11}^*(t) \delta(t) \psi_{11}(t) = (\Phi\pi)^3 |\psi(0)|^2 = (\Phi\pi)^3 \quad , \quad (\text{A.25})$$

as expected. There is no need for the separated path of integration in (A.22).

At the time of the publication of [30] in 2011, this writer was under the wrong impression that there exists a class of spike functions called δ functions, one which is

named after Dirac. A primitive definition of the Dirac δ function is

$$\delta(x - x_0) = \begin{cases} \infty & \text{for } x = x_0 \\ 0 & \text{otherwise} \end{cases}, \quad (\text{A.26})$$

but the $\delta(t)$ appearing in (A.24) was purposed as a generalized spike function

$$\bar{\delta}(x - x_0) = \begin{cases} \infty & \text{for } x = x_0 \\ 1 & \text{otherwise} \end{cases}. \quad (\text{A.27})$$

It is entirely reasonable that a reader would assume that $\delta(t)$ is the Dirac δ function from which the use case for a vanishing path of integration at infinity as in (A.22) does not follow in an intuitive way. Now we will describe how the path of integration in (A.22) follows from (A.27).

The expectation value for \hat{M}^3 requires an integral over all of time, but we have inserted a pole at $t = 0$ with $\bar{\delta}(0)$. Rather than to revise the definition of the expectation value, the pole is meant to separate time into the three regimes of Past, Present, and Future defined at the outset of [30]. A common method in physics for dealing with a pole along the path of integration in integral \mathcal{I} is to move the pole off of the path by the addition of an imaginary infinitesimal somewhere. Then one forms a closed path integral with \mathcal{I} and another path of integration at infinity along which the L^2 condition makes the integrand vanish at every point. Cauchy's residue theorem is applied to solve for $\mathcal{I} + 0$ as $2\pi i$ times the residue at the pole.

The meaning of (A.22) is that the closed path of integration in the Cauchy formula may be parsed as the process for \hat{M}^3 when we integrate as follows.

- From $t=0$ to $t_{\max} = \infty$ as Present \rightarrow Future.
- From t_{\max} along a path at infinity to $t_{\min} = -\infty$ as Future \rightarrow Past. (This path at infinity is now associated with the transit of \emptyset between Σ^\pm .)
- From t_{\min} back to $t=0$ as Past \rightarrow Present.

Although the unit cell was not constructed when [30] was published, these three paths along the closed Cauchy curve are like $\mathcal{H} \rightarrow \Omega$, $\Omega \rightarrow \mathcal{A}$, and $\mathcal{A} \rightarrow \mathcal{H}$. The current parameterization of this path in terms of χ^4 between two \mathcal{H} -branes may yet be simplified with Cauchy's theorem and a pole located in or near \mathcal{H} or \emptyset . A winding number is easily added to the Cauchy curve to identify the integration's start and endpoints with two different instances of \mathcal{H} rather than with each other.

Aside from presenting the main result, the remainder of [30] develops the algebra from which Einstein’s equation would be derived almost a year later in [3]. It was emphasized heavily in subsequent work that the MCM derivation of Einstein’s equation may appear to have been goal-sought, or reverse engineered, but no such thing was the case. The algebra in which Einstein’s equation appeared was assembled long before the GR result was found and reported in [3]. The comment on Palev statistics in [3] reflects a comment made to this writer by Finkelstein (Section 33) who had gone into professor emeritus status shortly before this writer was accepted as a PhD candidate and awarded a prestigious fellowship at Georgia Tech. The possible relevance of Palev statistics was never investigated, and it may have been a monkey wrench thrown into the works by a notorious and miserly detractor of the MCM.

As one further remark on the algebra developed in [30], the reader is invited to notice that [30]’s Equation (18) is a rich algebraic structure indeed. It is not cited as a thesis in the main body of this paper, but this algebra should be reconstructed in the language of Galois theory, if possible. The structure is quite rich. This writer has never seen another like it, but that may reflect this writer’s limited exposure to abstract algebra.

The conclusion of [30] gives a suggestion to look for delay correlations in particle collider data.

“If variations in α can be detected by varying the delay between an event and its measurement in an experimental apparatus[,] that will strongly support the ideas presented here.”

Very soon after this prediction was published, the BaBar collaboration discovered time reversal symmetry violation through delay correlations in their previously collected data [32]. In earlier work on the MCM [31], dark energy had been described as a delay correlation of sorts, and the algebraic structure around [30]’s equation (15)—the $\varphi^{**} \neq \varphi$ property of \mathbb{C}_{\pm}^* —was meant to break time reversal symmetry. Particularly, if the space of states in the past is different than the space of states in the present, it was suspected that the duration between an event and its observation would have observable correlations. Since the experimental quantity in context was the FSC, it was suggested that the delay correlations would manifest in its observed value.

The following is a summary of the prominent issues with the original formulation in [30].

- The well-known state ψ of a quantum particle in a 2D infinite square well was

employed as

$$\hat{\Upsilon}|\psi\rangle = (\partial_x + \partial_t^3)|\psi\rangle = \alpha_{\text{MCM}}^{-1}|\psi'\rangle . \quad (\text{A.28})$$

The tick mark showing that ψ is not an eigenstate of $\hat{\Upsilon}$ was omitted. The state

$$\psi_{nm} = \frac{2}{\sqrt{LD}} \sin\left(\frac{n\pi x}{L}\right) \sin\left(\frac{m\pi t}{D}\right) . \quad (\text{A.29})$$

of a 2D particle in a box spanned by x and t in respective dimensions L and D (length and duration) is not an eigenstate of $\partial_x + \partial_t^3$. Since α is observable, the general axiomatic framework of QM suggests that a Hermitian operator should return α^{-1} when acting on an eigenvector. The given ψ_{nm} fails to satisfy an eigenvalue equation with $\hat{\Upsilon}$ as defined.

- α_{MCM}^{-1} is returned only upon choosing $L=1/2$ and $D=2\varphi L$. The fixed dimensions of the box are associated easily enough with the fixed abstract dimensions of the unit cell, but no explanation for this ratio was proposed.
- α_{MCM}^{-1} is returned as the $nm=11$ eigenvalue of ψ_{nm} , but there is no ready interpretation for the other nm eigenvalues. α^{-1} should be returned by an *ontological*, or unique, eigenstate without an unbounded spectrum of other values for n and m .
- While the single spatial derivative in $\hat{\alpha} = \partial_x + \partial_t^3$ was natural to the 2D box model, the full theory would have three spatial derivatives inherent to the ∇ operator. With α being rooted historically in 3D atomic physics, the initial context for one spatial dimension must be generalized to the full theory. It seems likely that this generalization would unfixably alter the 2π part of α_{MCM}^{-1} .
- In the statement $\hat{\Upsilon} = \hat{\mathcal{U}} + \hat{M}^3$, the relationship between $\hat{\mathcal{U}}$ and ∂_x inherent to

$$\hat{\mathcal{U}}(t, t_0) = \exp\left\{\frac{-i\hat{H}(t - t_0)}{\hbar}\right\} , \quad (\text{A.30})$$

reflects only the simplest case of a time-independent Hamiltonian. Already, a function for extracting one linear ∂_x from $\hat{\mathcal{U}}$ seems too complicated. The generalization to a time-dependent Hamiltonian would be an analytical mess. Backing ∂_x out of the Dyson series representation of a Hamiltonian such that $[\hat{H}(t_0), \hat{H}(t_1)] \neq 0$ may not be possible.

Appendix B: Focused Review of Quantum Mechanics

To build up a well-known operator formalism which shall be extended with \hat{M}^3 , we will begin in the basis of position eigenstates. This is the usual path of development for QM because it connects so well with the picture of classical physics. Much of this appendix follows Sakurai and Napolitano [84].

B.1 The Translation Operator

By definition, position eigenstates are eigenvectors of the position operator

$$\hat{x}|x\rangle = x|x\rangle \quad . \quad (\text{B.1})$$

The position operator \hat{x} has a complete, continuous spectrum. The completeness relation is

$$\mathbb{1} = \int dx |x\rangle\langle x| \quad . \quad (\text{B.2})$$

To move a particle from position x_1 to position x_2 , the machinery of quantum mechanics requires that we operate on $|x_1\rangle$ with an operator such that $|x_2\rangle$ is the result. We will call that operator the translation operator and label it $\hat{\mathcal{J}}$. Evidently, it satisfies

$$\hat{\mathcal{J}}(\Delta x)|x\rangle = c|x + \Delta x\rangle \quad . \quad (\text{B.3})$$

This equation comes directly from the physics of motion: $\hat{\mathcal{J}}$ moves $|x\rangle$ to $|x + \Delta x\rangle$. Now it remains to reverse engineer the analytical form of the operator. Similarly, we have proposed that \hat{M}^3 should move $|\psi\rangle$ like so, like so, and like so, and then left a determination of the actual machinery to a later endeavor. This is what is done with $\hat{\mathcal{J}}$ and other operators: one conceives of an operation, labels the operator that does it, and then works out what it has to be. It is no hoax that we have written (B.3) without knowing what mathematical form $\hat{\mathcal{J}}$ might take, and neither is the MCM reliance on \hat{M}^3 without first defining its analytical form. This is business as usual in quantum theory.

It is for a good reason that

$$\hat{M}^3|\psi; \mathcal{H}_1\rangle = c|\psi; \mathcal{H}_2\rangle \quad , \quad (\text{B.4})$$

looks like (B.3). $\hat{\mathcal{J}}$ is the spatial translation operator, and \hat{M}^3 is another kind of translation-like operator between unit cells. \hat{M}^3 is necessarily more complicated than $\hat{\mathcal{J}}$ because it must be uniquely complemented by a time evolution to the later chronological time on the forward \mathcal{H} -brane, and this added complexity is part of why \hat{M}^3 is

posed as three separate operations while $\hat{\mathcal{J}}$ is not.

To work out the mathematical representation of $\hat{\mathcal{J}}$ based on the physics assigned to it, first we will consider infinitesimal 1D translations:

$$\hat{\mathcal{J}}(dx)|x\rangle = c|x+dx\rangle . \quad (\text{B.5})$$

For ease in notation, we will set $c=1$. As per usual in quantum mechanics, we will explore the mathematical structure by inserting (B.2): the completeness relation. Assigning the dummy integration variable x' , we have

$$\begin{aligned} \hat{\mathcal{J}}(dx)\mathbb{1}|x\rangle &= \hat{\mathcal{J}}(dx) \int dx' |x'\rangle\langle x'|x\rangle \\ &= \int dx' \hat{\mathcal{J}}(dx)|x'\rangle\langle x'|x\rangle \\ &= \int dx' |x'+dx\rangle\langle x'|x\rangle . \end{aligned} \quad (\text{B.6})$$

The quantity $\langle x'|x\rangle$ is interpreted as the expansion coefficient of $\hat{\mathcal{J}}(dx)|x\rangle$ written in the basis of $|x'+dx\rangle$ states. That basis is merely the position basis with position measured from an origin shifted by dx , so we will introduce a coordinate transformation to shift it back. Using

$$x'' = x' + dx \quad \Longrightarrow \quad dx'' = dx' , \quad (\text{B.7})$$

we obtain

$$\hat{\mathcal{J}}(dx)|x\rangle = \int dx'' |x''\rangle\langle x'' - dx|x\rangle . \quad (\text{B.8})$$

Since x' and x'' are only dummy variables, we can forget about the old x' and rename x'' as the new x' :

$$\hat{\mathcal{J}}(dx)|x\rangle = \int dx' |x'\rangle\langle x' - dx|x\rangle , \quad (\text{B.9})$$

The expansion coefficient $\langle x' - dx|x\rangle$ is called “the position space wavefunction,” and it is written as $x(x' - dx)$. If we would have used “ $|\psi\rangle$ ” to label the operand in (B.5) rather than “ $|x\rangle$,” then the wavefunction would be the more familiar looking $\psi(x' - dx)$. In that case, we would write

$$\hat{\mathcal{J}}(dx)|\psi_1\rangle = c|\psi_2\rangle . \quad (\text{B.10})$$

This should make it obvious why it can be better to label position states with their positions than Greek letters. In the ψ labeling, we would have to add some notes

to say, “ ψ_1 is the state of being located at x and ψ_2 is the state of being located at $x + dx$.” That would be cumbersome, but it is demonstrative to emphasize that the $\langle x' - dx|x \rangle$ appearing in (B.9) is an ordinary $\psi(x)$ despite it being written here as $x(x')$. Overall, (B.10) does not *obviously* communicate the physics we have assigned to $\hat{\mathcal{J}}$ in the forthright manner of (B.5).

We have explained that inserting the completeness relation into the definition of infinitesimal translation makes the wavefunction appear, but we have not yet clarified what the wavefunction is. Since the wavefunction (in position space) is the expansion coefficient in the continuous basis (of position states), we should build up an expansion in a discrete basis, and then generalize it to the continuous basis so that the wavefunction is not mysterious in any way. Then we will return to the analytical form of $\hat{\mathcal{J}}$ in the following subsection.

B.1.1 Interpretation of Basic Formalism in Quantum Mechanics

If one measures position, there is a continuum of different positions one might observe, so we say the spectrum of the position operator is continuous. Let there be an observable operator \hat{A} such that there are only a finite number of quantized (discrete) values that might be observed in a measurement of observable A . In the $\{|a_k\rangle\}$ eigenbasis of \hat{A} , we have

$$\hat{A}|a_k\rangle = a_k|a_k\rangle \quad , \quad (\text{B.11})$$

which mimics the eigenvalue equation for the position operator: (B.1). The difference is that there are an uncountably infinite number of positions x that one might find in a measurement of position, but there are only a finite number of a_k one might find when measuring observable A .

The fundamental idea in QM is that everything which can be observed may be represented as an operator. For a given observable, every possible value that may be found in an observation is an eigenvalue of that operator. The possible values of x (position) touch each other, and the spectrum of \hat{x} is called *continuous*. There are numerical gaps between the a_k , and, due to these gaps, the spectrum of \hat{A} is said to be *discrete*. The completeness relation for discrete eigenbases is

$$\mathbb{1} = \sum_k |a_k\rangle\langle a_k| \quad . \quad (\text{B.12})$$

If we operate on $|a_k\rangle$ with \hat{A} , we are guaranteed to get a_k since $|a_k\rangle$ is the eigenvector of \hat{A} with eigenvalue a_k . However, sometimes one does not know ahead of time what outcome a measurement will give. To determine what will happen when we measure

A on an unknown state ψ , we insert the completeness relation to *expand ψ in the eigenbasis of \hat{A}* as

$$|\psi\rangle = \mathbb{1}|\psi\rangle = \sum_k |a_k\rangle \langle a_k|\psi\rangle . \quad (\text{B.13})$$

As in (B.9), we have obtained an *expansion coefficient* $\langle a_k|\psi\rangle$. This is the discrete version of (B.9)'s $\langle x' - dx|x\rangle$, which we have called a *wavefunction*. Wavefunctions are the coefficients of expansion in a continuous basis. $\langle a_k|\psi\rangle$ is not a wavefunction, however. It is just a number. $\langle x' - dx|x\rangle$ is a wavefunction because it contains the integration variable x' .

If a state $|\psi\rangle$ has its representation expanded in the basis of an operator with a discrete spectrum, the probability for finding the a_k eigenvalue is the absolute square of the $\langle a_k|\psi\rangle$ expansion coefficient. If $|\psi\rangle$ is expanded in a continuous basis, this cannot be the program for finding the probability of any particular eigenvalue because the total probability, 100%, cannot be divided into uncountably many small but finite probabilities. This is the reason why the continuous basis coefficients contain integration variables. By integrating over a finite interval containing an uncountably infinite number of continuous eigenstates, one obtains a finite, real-valued probability. Rather than taking the absolute square of the constant c_k , one integrates $|\psi(x)|^2$ across some interval. The aggregate 100% probability can always be divided into real-valued fractions across finitely many finite intervals. This can be tricky for the beginners who are the intended audience for this appendix. Thus, we belabor the details. It is the intention to make MCM publications so plainly accessible to beginners that even novices might easily see through detractors' stupid remarks and baseless criticisms. Early work in the MCM written exclusively for subject matter experts was flawed in that regard because myriad scandalmongers and blowhards could levy any criticism free from accountability to many third parties who might judge for themselves.

We have expanded ψ in the eigenbasis of the observable represented by \hat{A} : (B.13). Since the expansion coefficients are not functions of any variables, they must be numbers, and we can simplify (B.13) as

$$|\psi\rangle = \mathbb{1}|\psi\rangle = \underbrace{\sum_k |a_k\rangle \langle a_k|}_{\text{Completeness}} \psi = \sum_k |a_k\rangle \underbrace{\langle a_k|\psi\rangle}_{c_k} = \sum_k c_k |a_k\rangle . \quad (\text{B.14})$$

For expansion in a continuous basis, we have

$$|\psi\rangle = \mathbb{1}|\psi\rangle = \underbrace{\int d\alpha | \alpha \rangle \langle \alpha |}_{\text{Completeness}} \psi\rangle = \int d\alpha | \alpha \rangle \underbrace{\langle \alpha | \psi \rangle}_{\psi(\alpha)} = \int d\alpha \psi(\alpha) | \alpha \rangle . \quad (\text{B.15})$$

Having made clear the role of the wavefunction $\psi(\alpha)$ as an expansion coefficient,¹ we will continue in the example of the discrete basis. Then we will say more about the continuous basis as the context develops.

Operating on ψ with \hat{A} does not represent a measurement of observable A . Rather, it yields a weighted sum of possible results of measurement. In the discrete case, the weight is the probability amplitude c_k for an eigenvalue a_k times the eigenvalue:

$$\hat{A}|\psi\rangle = \sum_k \hat{A}|a_k\rangle \langle a_k|\psi\rangle = \sum_k a_k |a_k\rangle c_k = \sum_k c_k a_k |a_k\rangle . \quad (\text{B.16})$$

This weighted average lends itself to the expectation value

$$\langle \hat{A} \rangle \equiv \langle \psi | \hat{A} | \psi \rangle . \quad (\text{B.17})$$

This is the average value that will be found across many measurements of A on identical ψ states. The orthonormal property of the $\{|a_k\rangle\}$ eigenbasis is such that

$$\langle a_j | a_k \rangle = \delta_{jk} ,^2 \quad (\text{B.18})$$

where δ_{jk} is the Kronecker δ , so acting on (B.16) from the left with $\langle \psi |$ yields a pure number:

$$\langle \psi | \hat{A} | \psi \rangle = \sum_j \sum_k c_j c_k a_k \langle a_j | a_k \rangle = \sum_j \sum_k c_j c_k a_k \delta_{jk} = \sum_k c_k^2 a_k . \quad (\text{B.19})$$

We know a measurement of A on state ψ will yield eigenvalue a_k with probability $P_k = |c_k|^2$, so the interpretation of (B.19) is that the *expectation value* $\langle \hat{A} \rangle$ is the probability weighted average of possible outcomes when measuring A . If ψ was an eigenstate of \hat{A} , then all the c_k would be equal to zero for every value of k except one. Then we could write $|\psi\rangle = c_j |a_j\rangle = |a_j\rangle$ and $\langle \hat{A} \rangle = a_j$ without including the sum because there is no need to sum the terms whose coefficients are zero.

Unless ψ is an eigenstate of \hat{A} , operation by \hat{A} does not return any one value of a_k , even though a lab measurement of A *will* return one and only one a_k . This shows

¹ $\psi(x)$ is mainly called the wavefunction when the continuous eigenbasis α is the position basis.

²Orthogonal means $\langle a_j | a_k \rangle = 0$ when $j \neq k$, and normalized means $\langle a_j | a_k \rangle = 1$ when $j = k$. Orthonormal means orthogonal and normalized.

what it means when we say that the collapse of the wavefunction is implemented in an “ad hoc” way in quantum mechanics. For states expanded in discrete bases, collapse looks like

$$\begin{aligned}
 |\psi\rangle_{\text{discrete}} &= \sum_k |a_k\rangle \langle a_k | \psi \rangle \\
 &= \sum_k c_k |a_k\rangle \xrightarrow{\text{measurement}} |a_j\rangle .
 \end{aligned}
 \tag{B.20}$$

One should compare this to (B.16) which shows that operating with \hat{A} on $|\psi\rangle$ does not reduce the state to a single eigenstate unless the initial state was an eigenstate. Reflecting the lack of a natural mathematical operation for wavefunction collapse upon measurement, the long labeled arrow shows that collapse happens *somehow*. In practice, after obtaining eigenvalue a_k in an experiment, the observer will use a $\hat{\mathcal{P}}_k$ projection operator to update ψ :

$$\hat{\mathcal{P}}_k |\psi\rangle = |a_k\rangle .
 \tag{B.21}$$

In the continuum, the same collapse behavior is written

$$\begin{aligned}
 |\psi\rangle_{\text{continuous}} &= \int dx' |x'\rangle \langle x' | \psi \rangle \\
 &= \int dx' \psi(x') |x'\rangle \xrightarrow{\text{measurement}} \psi(x') = \delta(x' - x_0) ,
 \end{aligned}
 \tag{B.22}$$

where $\delta(x' - x_0)$ is the Dirac δ function representing the x_0 position eigenstate in position space. This δ function makes the QM of continuous observables somewhat (or massively) more complicated than the QM of discrete observables. In the discrete case, the expansion coefficients for a particular basis were just the numbers $c_k \in \mathbb{C}$ whose squares are postulated to return real-valued probabilities. In the other case, they are differentials that need to be integrated. Namely, there is no k such that we much ask about a finite probability for being located at x_k . Instead, we ask about the probability for being found between x_k and x_j .

The discrete-continuous correspondence $c_k \leftrightarrow \psi(x)$ yields the following probability structure:

$$P_k = |\langle a_k | \psi \rangle|^2 = |c_k|^2 \iff P(x_k) dx' = |\langle x_k | \psi \rangle|^2 dx' = |\psi(x_k)|^2 dx' .
 \tag{B.23}$$

The dx' tells us that the probability of observing state $|\psi\rangle$ with exact continuous parameter x_k is infinitesimal. In practice, it is not possible to measure ψ at math-

emational point x_k due to resolution limits on physical devices, general principles of Heisenberg uncertainty, and, ultimately, Planck scale effects. While this writer is always eager to step forward with criticisms of quantum theory, (B.23) is a beautiful example of its robust power. The probability for observing a particle at a point is less than any positive real number. We would like to build devices that might detect particles at points, but such devices do not exist, and QM says they cannot exist. This is a great success among the many shortcomings that this writer is prone to highlight.

Since probability is dimensionless, the expansion coefficients $\psi(x)$ in the continuous basis have to have units of [meters] $^{-1/2}$ to cancel the units of dx' . These units are reflected in the normalization conditions

$$\begin{aligned} \langle \psi | \psi \rangle &= \langle \psi | \mathbb{1} | \psi \rangle = \sum_k \langle \psi | a_k \rangle \langle a_k | \psi \rangle = \sum_k c_k^* c_k = \sum_k |c_k|^2 = 1 & \text{(B.24)} \\ \langle \psi | \psi \rangle &= \langle \psi | \mathbb{1} | \psi \rangle = \int_{-\infty}^{\infty} dx' \langle \psi | x' \rangle \langle x' | \psi \rangle = \int_{-\infty}^{\infty} dx' |\psi(x')|^2 = 1 \quad . \end{aligned}$$

It follows from the units that $|\psi(x)|^2$ cannot be a real probability like $|c_k|^2$. Probability is dimensionless, but $|\psi(x)|^2$ is dimensionful. Calling attention to this radical alteration of the structure for the eigenbases of operators with continuous spectra, the expansion coefficient $\langle x | \psi \rangle = \psi(x)$ is called the position space wavefunction rather than simply an expansion coefficient. We often call the position space wavefunction “the wavefunction.” The important thing to know about wavefunctions is that they are the infinite number of expansion coefficients needed to expand an abstract state ket $|\psi\rangle$ in the infinite eigenbasis of some observable with a continuous spectrum. For $x_k \in (x_1, x_2)$, $\psi(x_k)$ (which is the function $\psi(x)$ evaluated at x_k) is the expansion coefficient of the $|x_k\rangle$ basis vector in the representation of $|\psi\rangle$ in the eigenstates of the \hat{x} operator.

For each of an uncountably infinite number of unique x in the spectrum of \hat{x} , there is a corresponding expansion coefficient $\psi(x)$. Mirroring the discrete expansion

$$|\psi\rangle_{\text{discrete}} = \sum_k c_k |a_k\rangle = c_1 |a_1\rangle + c_2 |a_2\rangle + c_3 |a_3\rangle + \dots \quad , \quad \text{(B.25)}$$

we would like to write the continuous expansion as

$$|\psi\rangle_{\text{continuous}} = \sum_x \psi(x) |x\rangle = \dots \psi(x') |x'\rangle + \psi(x'') |x''\rangle + \psi(x''') |x'''\rangle + \dots \quad . \quad \text{(B.26)}$$

However, the eigenvalue spectrum $\{x\}$ is an *uncountable* set. We can never enumer-

ate the various x eigenstates with natural numbers as we have for the a_k discrete eigenstates. Luckily, Newton has developed an excellent workaround for us. Written in the notation of Leibniz, the workaround is

$$|\psi\rangle_{\text{continuous}} = \int_{-\infty}^{\infty} dx' \psi(x') |x'\rangle . \quad (\text{B.27})$$

This workaround is great and useful, but it comes at the expense of the complications that we have discussed.

B.1.2 Back to the Translation Operator

Now that we understand the wavefunction, we will continue from (B.9) restated here:

$$\hat{\mathcal{J}}(dx)|\psi\rangle = \int dx' |x'\rangle \langle x' - dx|x\rangle = \int dx' \psi(x' - dx) |x'\rangle . \quad (\text{B.28})$$

We understand that the dx infinitesimal translation is a different sort of object than the dx' differential of the integration variable. We also understand that $\psi(x') = \langle x'|x\rangle$ is used because $x(x') = \langle x'|x\rangle$ is relatively unsightly. The minus sign in the argument of $\psi(x' - dx)$ seems to reflect translation by $-dx$ rather than by the dx that had been intended. This was a feature inherited by our change of variables in (B.7). Apparently, $\hat{\mathcal{J}}(-dx)$ is the operator that generates translation by dx :

$$\hat{\mathcal{J}}(-dx)|\psi\rangle = \int dx' \psi(x' + dx) |x'\rangle . \quad (\text{B.29})$$

We have seen that the c_k expansion coefficients give the probability for finding a_k in a measurement of the discrete observable A as $P_k = |c_k|^2$. In general, the c_k are called probability amplitudes, and the product with the complex conjugate c_k^* gives a real-valued probability. In the continuous case, the probability amplitude is the wavefunction, so we get $P(x) = |\psi(x)|^2 dx$ which results in a real-valued probability after it is integrated across some range. Since it has to be integrated, we call the modulus squared of $\psi(x)$

$$|\psi(x)|^2 = \psi^*(x)\psi(x) , \quad (\text{B.30})$$

a *probability density*. Before we operated with $\hat{\mathcal{J}}$, the wavefunction was $\psi(x)$. After, it was $\psi(x + dx)$ and the probability density was $|\psi(x + dx)|^2$. Evidently, the translation operator $\hat{\mathcal{J}}(-dx)$ has shifted the probability density for finding ψ in some region of space by the amount dx . We have succeeded in implementing the desired physics, but we have not yet obtained the analytical form of $\hat{\mathcal{J}}$. To get there, we will impose more physics.

- If $|x\rangle$ is properly normalized to $\langle x|x\rangle = 1$, then the translated state $|x'\rangle$ must maintain the normalization:

$$\langle x'|x'\rangle = \left[\langle x|\hat{\mathcal{J}}^\dagger \right] \left[\hat{\mathcal{J}}|x\rangle \right] = \langle x|\hat{\mathcal{J}}^\dagger \hat{\mathcal{J}}|x\rangle = 1 \quad \implies \quad \hat{\mathcal{J}}^\dagger \hat{\mathcal{J}} = 1 \quad .^1 \quad (\text{B.31})$$

In other words, we require that $\hat{\mathcal{J}}$ is a unitary operator. In general, unitary transformations preserve the norm of a ket.

- Two consecutive translations by Δx_1 and Δx_2 must be equal to a single translation by $\Delta x_1 + \Delta x_2$:

$$\hat{\mathcal{J}}(\Delta x_1)\hat{\mathcal{J}}(\Delta x_2) = \hat{\mathcal{J}}(\Delta x_1 + \Delta x_2) \quad . \quad (\text{B.32})$$

- Translation by Δx_1 and then $-\Delta x_1$ must be the identity operation:

$$\hat{\mathcal{J}}(-\Delta x_1)\hat{\mathcal{J}}(\Delta x_1) = \mathbb{1} \quad \implies \quad \hat{\mathcal{J}}(-\Delta x_1) = \hat{\mathcal{J}}^{-1}(\Delta x_1) \quad . \quad (\text{B.33})$$

(This follows from (B.32) in the case of $\Delta x_2 = -\Delta x_1$.)

- In the limit of vanishing displacement, the translation operator must reduce to the identity:

$$\lim_{dx \rightarrow 0} \hat{\mathcal{J}}(dx) = \mathbb{1} \quad . \quad (\text{B.34})$$

We still don't have an exact picture of the analytical form of $\hat{\mathcal{J}}$ though we have obtained have a detailed view of its physics. To move forward, we supplement these physical requirements with a mathematical requirement that $\hat{\mathcal{J}}(dx)$ should be linear in dx to leading order.

$$|\mathbb{1} - \hat{\mathcal{J}}(dx)| = \mathcal{O}(dx) \quad . \quad (\text{B.35})$$

Now the magic is made to happen with... *an ansatz!* We will guess that the form is

$$\hat{\mathcal{J}}(dx) = 1 - i\hat{K} dx \quad , \quad (\text{B.36})$$

for some Hermitian operator \hat{K} . It is often taken as a postulate of quantum mechanics that the generator of translations \hat{K} is the momentum operator \hat{p} times a constant.

When developing $\hat{\mathcal{J}}$ in [84], Sakurai and Napolitano proceed with a method by which one is able to deduce that the momentum operator satisfies the ansatz. Their method of Taylor series analysis necessarily introduces some gaps in the mathematical rigor at order $\mathcal{O}(dx^2)$. Ignoring $\mathcal{O}(dx^2)$ terms is perfectly standard in physics, and

¹Dagger denotes the conjugate transpose. For scalars, this is the ordinary complex conjugate.

taking $\hat{K} \propto \hat{p}$ directly as a postulate also introduces a gap in the first principles approach to understanding where everything comes from. However, all the expressions which follow from the $\hat{K} \propto \hat{p}$ postulate are exact while $\mathcal{O}(dx^2)$ gaps propagate through all the expressions which follow from the method of Taylor series analysis. Because the MCM has some concept of changing levels of aleph such that dx on one level of aleph might be finite on another level, we prefer to stay away from ignoring the $\mathcal{O}(dx^2)$ terms. Therefore, we postulate that \hat{K} is \hat{p} times a constant. From (B.36), we can see that \hat{K} does not have the correct units to be the momentum operator which should have units of mass times velocity. As it is, \hat{K} has units of inverse meters. Dimensional analysis shows that \hat{p} must be divided by something with units of action if it is to play the role of the generator of translations. Sakurai and Napolitano mention that if quantum physics had been developed in history before classical physics, the fundamental units would have been chosen so that this constant of proportionality between \hat{K} and \hat{p} was equal to one [84]. With units already having been set, it works out to \hbar :

$$\hat{\mathcal{J}}(dx) = 1 - \frac{i}{\hbar} \hat{p} dx \quad . \quad (\text{B.37})$$

Finite translations are obtained by compounding infinitesimal ones. To proceed in our quest to obtain the analytical form of

$$\hat{\mathcal{J}}(\Delta x)|x\rangle = |x + \Delta x\rangle \quad , \quad (\text{B.38})$$

we divide the finite (non-infinitesimal) translation Δx into N equal parts

$$\delta x = \frac{\Delta x}{N} \quad . \quad (\text{B.39})$$

Applying (B.32), we have

$$\hat{\mathcal{J}}(\Delta x) = \hat{\mathcal{J}}\left(\sum_{k=1}^N \delta x\right) = \prod_{k=1}^N \hat{\mathcal{J}}(\delta x) \quad . \quad (\text{B.40})$$

We make the connection to the generator of infinitesimal translations by taking the limit $N \rightarrow \infty$ such that $\delta x \rightarrow dx$. This yields

$$\hat{\mathcal{J}}(\Delta x) = \lim_{N \rightarrow \infty} \prod_{k=1}^N \hat{\mathcal{J}}(\delta x) = \lim_{N \rightarrow \infty} \left(1 - \frac{i\hat{p}_x \Delta x}{\hbar N}\right)^N \quad . \quad (\text{B.41})$$

This limit is a definition of the exponential function, so we have

$$\hat{\mathcal{J}}(\Delta x) = \exp \left\{ -\frac{i\hat{p}_x\Delta x}{\hbar} \right\} . \quad (\text{B.42})$$

If we are able to determine the analytical form of \hat{p} operating on position states, then we will have found the analytical form of the translation operator for such states.

B.2 The Momentum Operator

This section begins with a brief account of the road which led to “the creation of quantum mechanics” for which Heisenberg won the 1932 Nobel Prize in Physics. In 1925, Dirac described the kernel of what Heisenberg had done [233].

“It is well known that the experimental facts of atomic physics necessitate a departure from the classical theory of electrodynamics in the description of atomic phenomena. This departure takes the form, in Bohr’s theory, of the special assumptions of the existence of stationary states of an atom, in which it does not radiate,¹ and of certain rules, called quantum conditions, which fix the stationary states and the frequencies of the radiation emitted during transitions between them.² These assumptions are quite foreign to the classical theory, but have been very successful in the interpretation of a restricted region of atomic phenomena. The only way in which the classical theory is used is through the assumption that the classical laws hold for the description of the motion in the stationary states, although they fail completely during transitions, and the assumption, called the Correspondence Principle, that the classical theory gives the right results in the limiting case when the action per cycle of the system is large compared to Planck’s constant h , and in certain other special cases.

“In a recent paper [234] Heisenberg puts forward a new theory, which suggests that it is not the equations of classical mechanics that are in any way at fault, but that the mathematical operations by which physical results

¹Classical electromagnetic theory predicts that electrons undergoing centripetal acceleration in atomic orbits should radiate energy and fall into the nucleus. All classical charged particles radiate energy under acceleration, and the non-radiation of electrons in atomic orbitals was one of the main non-classical problems in the early days of atomic physics.

²In celestial mechanics, it is understood that a large asteroid impact might subtly alter the orbital radius of a planet around the sun. In atomic physics, the situation is totally different. When a photon hits an atomic electron, it cannot slightly alter the electron’s orbit. If the photon does not have enough energy to knock the electron all the way to the next fixed stationary state (orbit), then the photon will scatter elastically from the electron (having transferred zero energy.) This phenomenon describes the nature of quantum mechanics. In celestial mechanics, there are a continuum of orbital radii allowed for a planet to orbit the sun, but, in the atomic version of the solar system with electrons orbiting nuclei, the electron is only allowed certain discrete, or *quantized*, orbits.

are deduced from them require modification. All the information supplied by the classical theory can thus be made use of in the new theory. [...]

“We are now in a position to perform the ordinary algebraic operations on quantum variables. The sum of [*matrices*] x and y [, *with the nm matrix element of x denoted $x(nm)$*] is determined by the equations

$$\{x + y\}(nm) = x(nm) + y(nm) \quad , \quad (\text{B.42})$$

and the product by

$$xy(nm) = \sum_k x(nk)y(km) \quad , \quad (\text{B.43})$$

[...] An important difference now occurs between the two algebras. In general

$$xy(nm) \neq yx(nm) \quad , \quad (\text{B.44})$$

and quantum multiplication is not commutative, although, as is easily verified, it is associative and distributive. The quantity with components $xy(nm)$ [...] we shall call the Heisenberg product of x and y , and shall write simply as xy . Whenever two quantum quantities occur multiplied together, the Heisenberg product will be understood. Ordinary multiplication is, of course, implied in the products of amplitudes and frequencies and other quantities that are related to sets of n 's which are explicitly stated.”

Quantum quantities are what we now call observable operators. The quantities we observe commute in the usual way, but their representations in quantum theory do not. The principle manifestation of Heisenberg's quantum algebra is the commutator of position and momentum

$$[\hat{x}_j, \hat{p}_k] \equiv (\hat{x}_j \hat{p}_k - \hat{p}_k \hat{x}_j) = i\hbar \delta_{jk} \quad \implies \quad \hat{x} \hat{p}_x \neq \hat{p}_x \hat{x} \quad . \quad (\text{B.45})$$

A wonderful feature of quantum mechanics is that observables which can be known simultaneously have operators that commute. If two observables can't be known at the same time, their operators don't commute, meaning the commutator $[\hat{A}, \hat{B}]$ does not vanish. When two operators commute, we are able to find simultaneous eigenstates of both which save us the hassle of change of basis operations each time one or the other observable is to be measured. Intuitively, we know that 3D position can be measured in the lab, so we expect that the \hat{x} , \hat{y} , and \hat{z} observable operators should commute. $\psi(\mathbf{x}) = \delta(\mathbf{x})$ is a simultaneous eigenstate of all three operators which

we denote $|\mathbf{x}\rangle = |x, y, z\rangle$. That position and momentum can't commute follows from similar physical thinking. To measure momentum, one measures speed, mass, and direction. To measure speed, time is measured between two positions. Once a speed is determined, however, one must ask which of the two positions might be associated with it. Since we have only measured speed between two positions, we cannot rightly associate either of them with the measured speed. If we were to associate the average of the two positions with the speed, that would require an assumption of constant velocity between the two positions. This would be unphysical because we measured the average velocity between the two positions and have no way to know if it was constant on the interval. Therefore, we can be sure that $\hat{\mathbf{p}}$ won't commute with $\hat{\mathbf{x}}$ because the underlying quantities cannot be known simultaneously.¹ Other than that, we need to determine the analytical form of $\hat{\mathbf{p}}$ if we are going to answer the previous question about the analytical form of the translation operator $\hat{\mathcal{J}}(\Delta\mathbf{x})$ which depends on it, as in (B.42).

The guiding principle regarding the form of $\hat{\mathbf{p}}$ is that it has to return eigenvalue \mathbf{p} when it operates on a momentum eigenstate. Following along with the goal to determine the form of $\hat{\mathcal{J}}(\Delta\mathbf{x})$ acting on states in the position representation, we will consider momentum eigenstates in the position representation. Momentum eigenstates in the momentum representation can only be δ functions,² and, since the position representation is the Fourier transform of the momentum representation, the momentum eigenstate in that representation has to be a plane wave. Omitting factors of 2π and \hbar , the Fourier transform of $\psi(p) = \delta(p' - p)$ is

$$\psi(x) = \int dp' e^{-ip'x} \psi(p') = \int dp' e^{-ip'x} \delta(p' - p) = e^{-ipx} \quad . \quad (\text{B.46})$$

Momentum can be to the left or right (p can be positive or negative), so we may ignore the minus sign to write the *matrix elements* of a momentum eigenstate in the position representation as

$$\langle x|p\rangle = \psi_p(x) = e^{ipx/\hbar} \quad . \quad (\text{B.47})$$

If x and p were discrete, it would be easy to see that the set of all $\langle a_j|b_k\rangle$ forms a $j \times k$ matrix. For ease of description, we still call $\langle x|p\rangle$ a matrix element even though x and p are continuous. The subscript on $\psi_p(x)$ tells us that this is the wavefunction of the momentum eigenstate with eigenvalue p . Although momentum

¹It is somewhat miraculous that quantum theory should contain such physical constraints. By rights, there is no need for a theory to contain this functionality without additional input requiring it.

²This detail cannot be glossed over. Anyone attempting to learn QM from this appendix must be absolutely sure that they know exactly why a momentum eigenstate in the momentum representation must be a Dirac δ function.

eigenstates cannot be measured (all we can observe is momentum in some range) Heisenberg uncertainty suggests that exact knowledge of momentum implies maximal uncertainty in position. Thus, momentum eigenstates are maximally diffuse plane waves in the position representation. For a given p_0 and x_0 , the expression $\langle x|p \rangle$ gives the probability amplitude that a particle with momentum p_0 will be found at position x_0 . In other words, $\langle x|p \rangle$ is the wavefunction of the momentum eigenstate. Formally, we might say that there exist normalized solutions to Schrödinger's equation in the form

$$\psi_p(x) = A \exp\left\{\frac{i(px - Et)}{\hbar}\right\} = c(t) \exp\left\{\frac{ipx}{\hbar}\right\} \quad , \quad (\text{B.48})$$

but it suffices to ignore the time part. By optical inspection of (B.47) or (B.48), one determines that the momentum operator returning eigenvalue p when acting on a momentum eigenstate in the position representation is $-i\hbar\partial_x$:

$$\hat{p}\psi_p(x) = -i\hbar\frac{\partial}{\partial x} \exp\left\{\frac{ipx}{\hbar}\right\} = p \exp\left\{\frac{ipx}{\hbar}\right\} = p\psi_p(x) \quad . \quad (\text{B.49})$$

If we had used the e^{-ipx} wavefunction, then we would have gotten the $-p$ eigenvalue which is correct for a plane wave moving in the other direction. Ultimately, we take it as a postulate of quantum mechanics (surprise!) that the position representation of the momentum operator is

$$\hat{p} = -i\hbar\frac{\partial}{\partial x} \quad . \quad (\text{B.50})$$

The Heisenberg algebra follows directly:

$$\begin{aligned} [\hat{x}, \hat{p}]\psi_p &= \hat{x}\hat{p}\psi_p - \hat{p}\hat{x}\psi_p \\ &= -i\hbar\hat{x}\frac{\partial}{\partial x}\psi_p + i\hbar\frac{\partial}{\partial x}(x\psi_p) \\ &= xp\psi_p + \left(i\hbar\psi_p + i\hbar x\frac{\partial}{\partial x}\psi_p\right) \\ &= xp\psi_p + (i\hbar\psi_p - xp\psi_p) \\ &= i\hbar\psi_p \quad . \end{aligned} \quad (\text{B.51})$$

Now we may plug \hat{p} into (B.42) to write

$$\hat{\mathcal{J}}(\Delta x) = \exp\left\{-\frac{i\hat{p}_x\Delta x}{\hbar}\right\} = \exp\left\{-\Delta x\frac{\partial}{\partial x}\right\} \quad , \quad (\text{B.52})$$

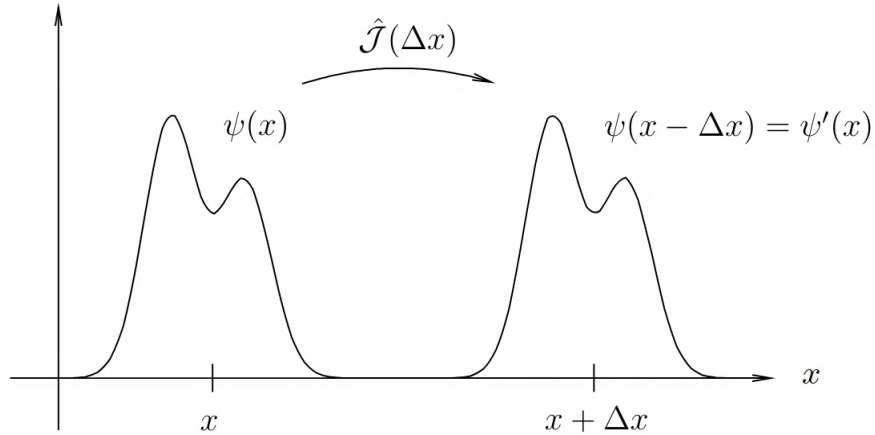

Figure 31: This figure adapted from Littlejohn [235] shows the action of the translation operator on an arbitrary wavefunction in the position representation. While the translation application from, say, \mathcal{H} at x to Ω at $x + \Delta x$ is obvious, more complicated operations are required for MCM applications. The MCM operation must alter the shape of $\psi(x)$. Such operations are time evolutions rather than spatial translations.

which is the analytical representation of $\hat{\mathcal{J}}!$ Testing it on the ψ_p wavefunction yields

$$\begin{aligned}
 \hat{\mathcal{J}}(\Delta x)\psi_p(x) &= \exp\left\{-\Delta x \frac{\partial}{\partial x}\right\} \exp\left\{\frac{ipx}{\hbar}\right\} \\
 &= \exp\left\{\frac{-ip\Delta x}{\hbar}\right\} \exp\left\{\frac{ipx}{\hbar}\right\} \\
 &= \exp\left\{\frac{ip(x - \Delta x)}{\hbar}\right\} \\
 &= \psi_p(x - \Delta x) \ .
 \end{aligned} \tag{B.53}$$

This agrees with (B.29). Another way to understand what is going on is to write

$$\hat{\mathcal{J}}(\Delta x)\psi_p(x) = \psi_p'(x) \ , \quad \text{and} \quad \psi_p'(x + \Delta x) = \psi_p(x) \ . \tag{B.54}$$

This tells us that the translated wavefunction ψ_p' at the shifted position is equal to the original wavefunction ψ at the unshifted position, as in Figure 31.

Now that we know what the momentum operator is, we may proceed with the derivation of the momentum operator as the generator of translations. We previously

skipped this around (B.36) by assuming (postulating)

$$\hat{\mathcal{J}}(dx) = 1 - i\hat{K} dx \quad , \quad \text{and} \quad \hat{K} \propto \hat{p} \quad , \quad (\text{B.55})$$

but now we will derive the $\hat{K} \propto \hat{p}$ part of our assumption. Translated by some small amount, the momentum eigenfunction is

$$\hat{\mathcal{J}}(-\delta x)\psi_p(x) = \psi_p(x + \delta x) = \exp\{ip(x + \delta x)\} = e^{ip\delta x}e^{ipx} = e^{ip\delta x}\psi_p(x) \quad . \quad (\text{B.56})$$

We expand the displacement term as

$$\psi_p(x + \delta x) = [1 + ip\delta x + \mathcal{O}(\delta x^2)] \psi_p(x) \quad , \quad (\text{B.57})$$

and compare to the Taylor series expansion of $\psi_p(x + \delta x)$ around x :

$$\begin{aligned} \psi_p(x + \delta x) &= \psi(x)_p + \delta x \frac{d}{dx} \psi_p(x) + \dots \\ &= \left[1 + i\delta x \left(-i \frac{d}{dx} \right) + \dots \right] \psi_p(x) \quad . \end{aligned} \quad (\text{B.58})$$

Equating $\mathcal{O}(\delta x)$ terms between (B.57) and (B.58), we find

$$-i \frac{d}{dx} \psi_p(x) = p\psi_p(x) \quad . \quad (\text{B.59})$$

This confirms that we have the correct form for the momentum operator. In the limit of infinitesimal δx , we ignore the $\mathcal{O}(\delta x^2)$ part of (B.57) to write

$$\begin{aligned} \psi_p(x + \delta x) &= (1 + ip\delta x) \psi_p(x) \\ &= \left[1 + i\delta x \left(-i \frac{d}{dx} \right) \right] \psi_p(x) \\ &= (1 + i\hat{p}\delta x) \psi_p(x) \\ &= \left[1 - i\hat{K}(-\delta x) \right] \psi_p(x) \\ &= \hat{\mathcal{J}}(-\delta x)\psi_p(x) \quad . \end{aligned} \quad (\text{B.60})$$

By ignoring the $\mathcal{O}(\delta x^2)$ terms and assuming that we can set terms of equal order in δx equal between (B.57) and (B.58), and by assuming $\hat{\mathcal{J}} = 1 - i\hat{K} dx$ to begin with, we have made a derivation showing that the momentum operator is the generator of spatial translations. This supplements our postulate/axiom which says the same

thing.

Momentum in quantum mechanics goes on to be very complicated. Mainly, it is only possible to define the momentum operator as the mass times the derivative of position when the vector potential \mathbf{A} is equal to zero. This equality gives what is called the canonical momentum operator $\hat{\mathbf{p}}$. In general, however, we have

$$\frac{d}{dt} \hat{\mathbf{x}} = \frac{1}{m} \left(\hat{\mathbf{p}} - \frac{e}{c} \mathbf{A}(\hat{\mathbf{x}}) \right) . \quad (\text{B.61})$$

Thus, we introduce the kinematical momentum operator

$$\hat{\mathbf{\Pi}} = m \frac{d}{dt} \hat{\mathbf{x}} = \hat{\mathbf{p}} - \frac{e}{c} \mathbf{A}(\hat{\mathbf{x}}) . \quad (\text{B.62})$$

The main difference between the canonical and kinematical momenta is

$$[\hat{p}_k, \hat{p}_j] = 0 \quad , \quad \text{while} \quad [\hat{\Pi}_k, \hat{\Pi}_j] \neq 0 . \quad (\text{B.63})$$

It is known that the vector potential is not unique, and the tricks that one can play with $\mathbf{A}(\hat{x})$ are the main inroads to theories of gauge freedom, or gauge theories. Usually the choice of one $\mathbf{A}(\hat{x})$ or another is called *fixing the gauge*. In turn, this defines the kinematical momentum operator which replaces the \hat{p} we have postulated above.

B.3 The Time Evolution Operator

It is said that time doesn't exist in quantum mechanics. What is meant is that states in Hilbert space are represented as functions of spatial variables but not time. The time dependence is added to states as a phase factor which is constant in the Hilbert space of states at time t . In the case of time-dependent Hamiltonian operators, there is a Hilbert space of energy eigenstates corresponding to every possible $\hat{H}(t)$. Even in the case of a time-independent Hamiltonian, there is still a Hilbert space of energy eigenstates at every time t . This can get glossed over since the eigenstates in each Hilbert space are the same complete set of orthonormal basis states. However, the eigenstates of every observable operator do, in fact, belong to a Hilbert space at a specific time which is distinct from the space of states at any other time.

To develop time evolution, we will introduce the symbol $|\psi, t_0; t\rangle$ as the state of a system at time $t > t_0$ that was already observed to be in state ψ at time t_0 . We have

previously implemented the spatial translation operator $\hat{\mathcal{J}}$ such that

$$\hat{\mathcal{J}}(\Delta\mathbf{x})|\mathbf{x}\rangle = |\mathbf{x} + \Delta\mathbf{x}\rangle \quad , \quad (\text{B.61})$$

and now we will develop the time translation operator as

$$\hat{\mathcal{U}}(t, t_0)|\psi, t_0\rangle = |\psi, t_0; t\rangle \quad . \quad (\text{B.62})$$

By convention, this is called the time evolution operator. The added argument t_0 tells us that $\hat{\mathcal{U}}(t, t_0)$ *only* operates on the Hilbert space of states which exist at time t_0 . This is redundant for time-independent Hamiltonians, but it is not redundant in general. The requirements imposed on $\hat{\mathcal{U}}(t, t_0)$ are mostly the same as those imposed on $\hat{\mathcal{J}}$.

- If $|\psi, t_0\rangle$ is properly normalized to $\langle\psi, t_0|\psi, t_0\rangle = 1$, then the time evolved state $|\psi, t_0; t\rangle$ must maintain the normalization:

$$\langle\psi, t_0; t|\psi, t_0; t\rangle = \langle\psi, t_0|\hat{\mathcal{U}}^\dagger\hat{\mathcal{U}}|\psi, t_0\rangle = 1 \quad \implies \quad \hat{\mathcal{U}}^\dagger(t_0, t)\hat{\mathcal{U}}(t_0, t) = 1 \quad . \quad (\text{B.63})$$

- Two consecutive time evolutions, $\hat{\mathcal{U}}(t_1, t_0)$ followed by $\hat{\mathcal{U}}(t_2, t_1)$, must be equal to a single time evolution by $\hat{\mathcal{U}}(t_2, t_0)$:

$$\hat{\mathcal{U}}(t_2, t_1)\hat{\mathcal{U}}(t_1, t_0) = \hat{\mathcal{U}}(t_2, t_0) \quad . \quad (\text{B.64})$$

- Evolution by Δt_1 and then $-\Delta t_1$ must be the identity operation:

$$\hat{\mathcal{U}}(-\Delta t_1)\hat{\mathcal{U}}(\Delta t_1) = \mathbb{1} \quad \implies \quad \hat{\mathcal{U}}(-\Delta t_1) = \hat{\mathcal{U}}^{-1}(\Delta t_1) \quad . \quad (\text{B.65})$$

- In the limit of vanishing temporal displacement, the evolution operator must reduce to the identity:

$$\lim_{t \rightarrow t_0} \hat{\mathcal{U}}(t, t_0) = \mathbb{1} \quad . \quad (\text{B.66})$$

- $\hat{\mathcal{U}}(t_0 + dt, t_0)$ should be linear in dt to leading order:

$$|1 - \hat{\mathcal{U}}(t_0 + dt, t_0)| = \mathcal{O}(dt) \quad . \quad (\text{B.67})$$

The unitarity condition of (B.63) is required for the preservation of the probability interpretation in which $c_k^2(t)$ is the probability for finding eigenvalue a_k at time t . This is demonstrated when we require that the sum of the squares of the expansion

coefficients in a particular basis must sum to unity at all times. To demonstrate, we expand in the discrete basis of $|a_k\rangle$:

$$|\psi, t_0\rangle = \sum_k |a_k\rangle \langle a_k | \psi, t_0\rangle = \sum_k c_k(t_0) |a_k\rangle \quad . \quad (\text{B.68})$$

The meaning of $c_k(t_0)$ is exactly the same as the previous meaning of c_k . We add the time dependence because the probability for finding the a_k eigenvalue in a measurement on $|\psi\rangle$ might not be constant in time. For example, if one prepares a system in an excited state, it will become less and less likely that one will observe the system in the excited state as time goes on. On long time scales, systems tend to return to the ground state and/or come to thermodynamic equilibrium.

Assume that ψ is normalized at t_0 . Multiplying (B.68) from the left with $\langle\psi, t_0|$ yields

$$\langle\psi, t_0 | \psi, t_0\rangle = \sum_k c_k(t_0) \langle\psi, t_0 | a_k\rangle = \sum_k c_k(t_0) c_k^*(t_0) = \sum_k |c_k(t_0)|^2 = 1 \quad . \quad (\text{B.69})$$

Since t_0 is an arbitrary time, this has to hold for any $t \neq t_0$, so

$$\langle\psi, t_0; t | \psi, t_0; t\rangle = \sum_k \langle\psi, t_0; t | a_k\rangle \langle a_k | \psi, t_0; t\rangle = \sum_k c_k(t) c_k^*(t) = \sum_k |c_k(t)|^2 = 1 \quad . \quad (\text{B.70})$$

Time evolution can alter the expansion coefficients in the expansion of an abstract state in a certain basis, but the sum the coefficients' absolute squares always adds up to one. This tells us that the probability of finding the state in one of the possible eigenstates is always 100%.

As with the generator of translation $\hat{\mathcal{J}}$, we will assume

$$\hat{\mathcal{U}}(t_0 + dt, t_0) = 1 - i\hat{\Omega} dt \quad , \quad (\text{B.71})$$

and then proceed to determine $\hat{\Omega}$. Studying $\hat{\mathcal{J}}$, it was not mentioned that these ansatzes are not exactly unitary. Presently, we have

$$(1 - i\hat{\Omega} dt)^\dagger (1 - i\hat{\Omega} dt) = 1 + \hat{\Omega}^2 dt^2 \quad , \quad (\text{B.72})$$

though unitary operators satisfy

$$\hat{\mathcal{O}}^\dagger \hat{\mathcal{O}} = \mathbb{1} \quad . \quad (\text{B.73})$$

As is usual, we ignore $\mathcal{O}(dt^2)$ terms and proceed via the minimal hand waving method

to call \hat{U} the *unitary time evolution operator*. There are some principles of classical mechanics which motivate the Hamiltonian as the generator of time evolutions, but we will simply postulate

$$\hat{\Omega} = \frac{1}{\hbar} \hat{H} \quad . \quad (\text{B.74})$$

The Hamiltonian operator \hat{H} is constructed by promoting all instances of positions and momenta in the classical Hamiltonian to their corresponding operators, or “quantum quantities.”

Now we will derive the fundamental equation for \hat{U} . The composition property of \hat{U} is given by (B.64). Combining the compositive law with the (B.71) ansatz, we have

$$\begin{aligned} \hat{U}(t + \delta t, t_0) &= \hat{U}(t + \delta t, t) \hat{U}(t, t_0) \\ &= \left(1 - i \frac{1}{\hbar} \hat{H} \delta t \right) \hat{U}(t, t_0) \\ &= \hat{U}(t, t_0) + \frac{1}{i\hbar} \hat{H} \delta t \hat{U}(t, t_0) \quad . \end{aligned} \quad (\text{B.75})$$

By moving $\hat{U}(t, t_0)$ to the left hand side and multiplying both sides by $i\hbar/\delta t$, we obtain

$$i\hbar \frac{\hat{U}(t + \delta t, t_0) - \hat{U}(t, t_0)}{\delta t} = \hat{H} \hat{U}(t, t_0) \quad . \quad (\text{B.76})$$

In the limit $\delta t \rightarrow dt$, the left side contains the definition of the derivative with respect to t :

$$i\hbar \frac{\partial}{\partial t} \hat{U}(t, t_0) = \hat{H} \hat{U}(t, t_0) \quad . \quad (\text{B.77})$$

As it turns out, (B.77) is the Schrödinger equation for the time evolution operator. We obtain Schrödinger’s equation for states by multiplying from the right with $|\psi, t_0\rangle$. This yields

$$\begin{aligned} i\hbar \frac{\partial}{\partial t} \hat{U}(t, t_0) |\psi, t_0\rangle &= \hat{H} \hat{U}(t, t_0) |\psi, t_0\rangle \\ i\hbar \frac{\partial}{\partial t} |\psi, t_0; t\rangle &= \hat{H} |\psi, t_0; t\rangle \quad , \end{aligned} \quad (\text{B.78})$$

which is the famous time-dependent Schrödinger equation. If we know how $\hat{U}(t, t_0)$ evolves, then we don’t need Schrödinger’s equation for states. We can operate directly on the states with the time evolution operator \hat{U} to generate states at arbitrary times given that the state was known at t_0 . Therefore, we will solve Schrödinger’s equation

for $\hat{U}(t, t_0)$, and then act on states with \hat{U} to obtain states at later times.

First we will examine the time-independent case of $\hat{H} \neq \hat{H}(t)$. The familiar looking (hopefully) differential equation (B.77) is solved by optical inspection as

$$\frac{\partial}{\partial t} \hat{U}(t, t_0) = \frac{1}{i\hbar} \hat{H} \hat{U}(t, t_0) \quad \Longrightarrow \quad \hat{U}(t, t_0) = \exp \left\{ \frac{-i\hat{H}(t - t_0)}{\hbar} \right\} . \quad (\text{B.79})$$

As a reminder that not all differential equations are solved by optical inspection, we continue from (B.77) as

$$\begin{aligned} \frac{\partial}{\partial t} \hat{U}(t, t_0) &= \frac{1}{i\hbar} \hat{H} \hat{U}(t, t_0) \\ \frac{1}{\hat{U}(t, t_0)} \frac{\partial}{\partial t} \hat{U}(t, t_0) &= \frac{1}{i\hbar} \hat{H} \\ \int_{t_0}^t dt' \frac{1}{\hat{U}(t', t_0)} \frac{\partial}{\partial t'} \hat{U}(t', t_0) &= \frac{1}{i\hbar} \hat{H} \int_{t_0}^t dt' . \end{aligned} \quad (\text{B.80})$$

We proceed by u -substitution:

$$u = \hat{U}(t', t_0) \quad \Longrightarrow \quad du = \frac{\partial}{\partial t'} \hat{U}(t', t_0) dt' , \quad (\text{B.81})$$

yields

$$\int_{u(t_0)}^{u(t)} \frac{du}{u} = \int_{\hat{U}(t_0, t_0)}^{\hat{U}(t, t_0)} \frac{d\hat{U}}{\hat{U}} . \quad (\text{B.82})$$

We continue from (B.80) as

$$\begin{aligned} \int_{\hat{U}(t_0, t_0)}^{\hat{U}(t, t_0)} \frac{d\hat{U}}{\hat{U}} &= \frac{1}{i\hbar} \hat{H} \int_{t_0}^t dt' \\ \ln \hat{U} \Big|_{\hat{U}(t_0, t_0)}^{\hat{U}(t, t_0)} &= \frac{1}{i\hbar} \hat{H} t' \Big|_{t_0}^t \\ \ln [\hat{U}(t, t_0)] - \ln [\hat{U}(t_0, t_0)] &= \frac{1}{i\hbar} \hat{H} (t - t_0) . \end{aligned} \quad (\text{B.83})$$

The $\hat{U}(t_0, t_0)$ operator on the left is the identity by (B.66). The log of the identity

vanishes. Taking the exponential of both sides yields

$$\hat{\mathcal{U}}(t, t_0) = \exp\left\{\frac{-i\hat{H}(t - t_0)}{\hbar}\right\} . \quad (\text{B.84})$$

This is the unitary evolution operator for a state at time t_0 subject to a time-independent Hamiltonian. Although the ansatz stated in (B.71) was not exactly unitary, the present form of $\hat{\mathcal{U}}$ given in (B.84) is exactly unitary because it is the exponential of a Hermitian operator.

If the Hamiltonian is a function of time, and if $[\hat{H}(t_1), \hat{H}(t_2)] = 0$ for any t_1, t_2 , the solution proceeds identically except we cannot take $\hat{H}(t)$ out of the integral as we have in (B.80). The result is

$$\hat{\mathcal{U}}(t, t_0) = \exp\left\{-\frac{i}{\hbar} \int dt' \hat{H}(t')\right\} . \quad (\text{B.85})$$

If the Hamiltonian is a function of time and $[\hat{H}(t_1), \hat{H}(t_2)] \neq 0$, then the solution is much more complicated. In general, it will be expressed as a Dyson series:

$$\hat{\mathcal{U}}(t, t_0) = 1 + \sum_{k=1}^{\infty} \left(\frac{-i}{\hbar}\right)^k \int_{t_0}^t dt_1 \int_{t_0}^{t_1} dt_2 \dots \int_{t_0}^{t_{k-1}} dt_n \hat{H}(t_1) \hat{H}(t_2) \dots \hat{H}(t_k) . \quad (\text{B.86})$$

The $k = 1$ term is a single integral, the $k = 2$ term is a double integral, etc. The $k = \infty$ term is an infinite-dimensional integral, notably. Although any finite $\Delta t = t - t_0$ necessarily contains an uncountable infinity of different times t_k at which the Hamiltonian does not commute, the countable terms of the Dyson series offer a decent approximation. Examples of these three increasingly difficult cases of $\hat{\mathcal{U}}$ are a spin magnetic moment in (i) a static field such that $\hat{H} \neq \hat{H}(t)$, (ii) a time-varying field with a constant direction such that $\hat{H} = \hat{H}(t)$ but $[\hat{H}(t_1), \hat{H}(t_2)] \neq 0$, and (iii) a field varying in strength and direction such that the time-dependent Hamiltonians at different times do not commute.

Observables that commute with the Hamiltonian are constants of the time evolution generated by Schrödinger's equation. In general, one defines a *correlation amplitude* $C(t)$ as a measure of the difference between $|\psi, t_0\rangle$ and $|\psi, t_0; t\rangle$. $C(t)$ is a measure of how quickly diffusion sets in, or how quickly a state will thermalize. Thermalization is the process by which an eigenstate will evolve into a superposition of eigenstates if left unobserved.

This appendix has described what is called the Schrödinger picture of quantum

mechanics, but there exist other pictures such as the Heisenberg and interaction pictures wherein the conventions for grouping different objects are slightly different. In the Heisenberg picture, for example, operators vary in time while states are constant. A good understanding of the basics requires understanding at least the Heisenberg and Schrödinger pictures.

Appendix C: Historical Context

This appendix first appeared as Section 3.2 in [1]. A few new footnotes and minor edits appear in this transcription.

The first written description of the MCM appears in [31]. It was rejected by arXiv in September 2009, and it is the likely basis for the articles titled “Is the Universe Inside a Black Hole?” that Nikodem Poplawski has been successfully pushing to popular media since 2010 [236–244]. The MCM phrase *inverse radial spaghettification*¹ [40] is a fancy way to say that the universe is inside a black hole. In newer research, we have gone on to show that the observer resides on a singularity at the origin of coordinates marking each level of aleph.² It is commonly understood that singularities mark the center of black holes, so universe-in-a-black-hole is very much a facet of the MCM. We suggest that Poplawski began providing material for these articles after he was inspired to do so by the original MCM manuscript [31], which he obtained *somehow*.

At the end of September 2009, similarly, Ashtekar, Campiglia, and Henderson published [50] wherein the first citation is to the Feynman paper [68] that was considered in the introduction to [1]. This is interesting because Ashtekar had not been citing Feynman’s war-era papers from 70 years earlier, but then he did do so immediately after this writer distributed [31]. That paper began with a quote taken from one of Feynman’s less famous war-era papers where he makes a comment about the time ordering of events not being as important as the way events are encoded in his formalism. ArXiv lists the submission date on Ashtekar et al.’s paper [50] as about one or two weeks after an anonymous reviewer at arXiv rejected [31].³ Since LQC was multiply cited in [31]⁴—LQC being a theory whose bottom-liners include Ashtekar⁵—it is not unlikely that the arXiv reviewer, if that was not Ashtekar himself, sent the manuscript to Ashtekar.

Ashtekar may have obtained the manuscript not through arXiv but through another channel. Just weeks before Ashtekar et al. published [50], this writer had distributed [31] in the newly opened Center for Relativistic Astrophysics (CRA) at Georgia Tech whose founding faculty include two former colleagues of Ashtekar’s:

¹Inverse radial spaghettification, a term coined in [40], describes the MCM mechanism for dark energy dependent on the rarefaction of time as the present accelerates toward the future more quickly than the past. Time rarefaction was called *inverse radial spaghettification*.

²We have since sought to disassociate the present and the singularity as \mathcal{H} and \emptyset . However, this convention was in place during the main publication period for the Poplawski articles [236–244].

³Unfortunately, we have no record of the date of the original submission of [31] to arXiv. It was probably around September 15, 2009.

⁴LQC and LQG were not cited directly in 2009. Instead we used the terms “bouncing” and “the repulsive force of quantum geometry” which were taken from Ashtekar’s 2009 LQC talk at Georgia Tech. (The record of this talk was subsequently deleted from the internet.)

⁵The bottom-liners also include Bojowald who declared LQC “dead” in 2013 (see [111]).

Pablo Laguna¹ and Deirdre Shoemaker. The purpose of the email distribution was to advertise that this writer would give a talk on the MCM in the CRA that week. Shoemaker, who had been working side by side with Ashtekar in Pennsylvania just a year earlier, attended the talk, but she was *most intently* on her phone for the duration,² almost intentionally projecting disinterest, or *disrespect*, and is unlikely to have made any effort to help this writer disseminate his research.

The key point in all of this is that, somehow, [31] was deemed not good enough even to appear on arXiv as a preprint, though it was good enough to prompt *an immediate response paper* from leading names in the field [50]. Usually eliciting a response paper at all is considered a high achievement in theoretical physics, and an immediate response from a leader in the field (Ashtekar) is high praise indeed.³ As a counterexample, consider that many papers passing the “very high,” “very meaningful,” and “critically important” bar of peer review go on to be completely ignored and accumulate a layer of dust serving as a reminder that it did, at one point, pass peer review, meaning that the publishing cartel bestowed a cookie upon the authors who can all add the cookie crumbs to their CV’s... which mean nothing weighed against the merit of the research that appeared in the publication. The cartel’s cookie crumbs have become overly important in the modern era where the merit of the research in question is too often non-existent or not significant.

Despite science’s alleged self-correcting mechanism, the exact dynamic from 2009 unfolded again in 2011. Once again, arXiv rejected another manuscript [40] based on their unpublished, uncited censorship guidelines. It seems that after this later manuscript made the back channel rounds, negative frequency resonant radiation was immediately discovered [43], and a team at USC immediately built a working quantum computer [245]. Note that since frequency is inverse time, negative frequency resonant radiation is a negative time mode exactly like the $|t_-\rangle$ state suggested only months earlier in [40]. In [30], we suggested to look for correlations with delay, then the BaBar collaboration announced that they had decided to reanalyze their old data for correlations with delay, and that they did affirmatively find them [32], just a few months later.

In 2009, the first account of the MCM [31] was “not good enough” even to be allowed as an arXiv preprint, but it garnered a praiseworthy response. In 2011, [40]

¹Laguna deserves an honorable mention and thanks for inviting not just Ashtekar to Georgia Tech, but also Penrose, meaning that both of the speakers that inspired the MCM were the invitees of Laguna.

²One wonders how Shoemaker could pursue a PhD, make it through the academic grinder into a tenure track position, get a promotion as a founding member of a center for relativistic astrophysics, and then show absolutely no interest when some of the most important astrophysical mysteries of the universe are plainly spelled out before her eyes on a whiteboard. Affirmative action likely explains the whole thing.

³Finkelstein wrote two MCM response papers [147,148] after arXiv rejected [31], but before they rejected [40].

still did not meet the bar of arXiv’s unpublished censorship criteria. Not only did that update garner MCM response papers, it garnered MCM response experiments. This is high praise indeed because experiments cost time *and* money whereas papers only cost time. It means that the “peers” of this writer have “reviewed” the manuscript and decided to change research direction in favor of the MCM. If the results of the experimental response had been negative, then the praise would be lessened only somewhat because it would still be true that we had presented an admirable new idea. This is the primary function of theorists: to theorize new theories. In that regard, one may compare the MCM to other very famous theories that are worse yet still manage to reap all of the praise offered by the community of theorists. Unlike the experimental tests of most respected and praiseworthy theories, however, the results of the MCM experimental response were all affirmative. Therefore, although the MCM has not passed “peer review,” it has been known for an experimental fact—multiple experimental facts, actually” [32,43,245] *at least!*—that it describes Nature better than any other theory that currently exists. This was known all throughout 2013, 2014, 2015, 2016, 2017, 2018, 2019, 2020, 2021, and at least several months in 2022, but there has been no accompanying update to the public understanding of science.

We are essentially accusing Abhay Ashtekar, Nikodem Poplawski, and others of plagiarism, but, in the technical sense, there has been no plagiarism. In the technical sense, the complaints listed here only suggest that the alleged self-correcting mechanism in science does not exist, and many tenured professionals do not conform to certain ethical standards. We pointed out Ashtekar et al.’s spurious Feynman citation as evidence of his having viewed [31], so consider that in [50], Ashtekar et al. wrote that they were being so vague not to avoid writing about the MCM directly, but rather because they would leave “the detailed derivations and discussions to a longer article.” Did those derivations exist at the time of the publication of [50]? Had they been first suggested after someone looked at the 2009 manuscript which arXiv rejected [31]? Perhaps they were suggested but not carried out during the hasty preparation and revision of the rough draft that preceded the preprint cited here as [50]? Perhaps the hastiness in that regard was motivated by a desire to fabricate a parallel false genesis for what *very obviously* appeared to them to be a fantastic new idea? One wonders if the promised detailed derivations ever did appear in the literature. If not, did they ever come into existence? If not, was [50] worded so as to mislead readers about the existence of the derivations?

Ashtekar et al. write the following in [50]. However, one wonders how they managed

to report a “rigorously developed Hamiltonian theory” without reporting a rigorous development of anything at all. To the extent that MCM papers are sometimes said to contain “nonsense,” it is suggested that this excerpt from [50] contains nonsense.

“Because of [...] the Schrödinger equation we can now pass to a sum over histories a la Feynman. [...] We emphasize that the result was derived from a Hamiltonian theory. We did not postulate that [*our equation*] is given by a formal path integral. Rather a rigorously developed Hamiltonian theory guaranteed that [*our equation*] is well-defined.”

In 2009’s [31], we did not include a detailed derivation, and we did not claim rigor without derivation, which is what Ashtekar et al. have done. The diagrams in [31] explain an idea much more clearly than Ashtekar et al. were able to explain anything with their non-rigorous rigor of math salad in [50]. They included neither diagrams nor derivations, but, somehow, their paper was good, and ours was found to be terrible. Not just terrible, [31] was determined to be so unacceptably terrible that it attained the rare bar of rejection at arXiv.

How have Ashtekar et al. “rigorously developed” their theory while leaving the “detailed derivations and discussions to a longer article?” The reader should be very careful to note that if the rigor of Ashtekar et al.’s result is offloaded elsewhere beyond their paper’s pages, then [31] and [50] are similar indeed! Ashtekar et al.’s murky, imprecise, arguably self-contradictory wording contrasts [31] wherein the abstract states, “No attempt at quantification is made.” Instead, we pursue a qualitative analysis of the diagrams that guarantee our framework is well defined. This *sharply* contrasts Ashtekar et al.’s [50] when the qualitative discussion of diagrams is practical to a degree far beyond the qualitative analysis of quantitative equations that don’t, when taken all together, form a rigorous derivation of anything. Generally, quantitative analysis is only superior to qualitative analysis when it is rigorous. Otherwise, math salad is not as good as pictures.¹

As an example of real quantitative rigor, consider the unassailable truth of the appearance of the coefficient of Einstein’s equation 8π in the first intuitive manipulations of the MCM once the equally unassailable truth of

$$2\pi + (\Phi\pi)^3 \approx 137 \quad , \quad (\text{C.1})$$

was established. Somehow, certain individuals have slunk into the halls of power in scholarship to convince everyone that Feynman was wrong when he is famously

¹In [246], Pugh writes, “One thing you will observe about all [*the books I suggest*]*—they use pictures to convey the mathematical ideas. Beware of books that don’t.*”

paraphrased as stating that all good physicists have the fine structure constant on the wall in their offices and ask themselves where it comes from, and that no one has a good explanation for it, and that it would probably be related to π if they did.

Given that Ashtekar et al. were able to produce the inferior analysis that became [50] within what was likely just days of reading about the MCM, and all within the context of their own years or decades long familiarity with their own material, it is demonstrated exactly how well defined the MCM already was in 2009. Ashtekar et al. strongly emphasize that their result was derived from a Hamiltonian theory, but they do not say whether or not they were inspired to make that derivation for the first time immediately after viewing the contentious paper that arXiv rejected in 2009 [31]. To the knowledge of this writer, they have not shown that the claimed derivations exist at all. When they wrote that they did not postulate that their formula was given by a formal path integral, was that to distinguish their paper from [31] wherein we postulated that the MCM is given by the formal path integral?

The critical reader will notice that “detailed derivations and discussions” are left out in both [31] and [50], but only one of them appears on arXiv today. In the acknowledgments section at the end of [50], Ashtekar et al.’s first thanks are to Jerzy Lewandowski who was the advisor or colleague of Poplawski at the University of Warsaw. In April 2010, around the time Poplawski began appearing in very many popular science articles about the universe being in a black hole, Poplawski also published [247]. Note how the title of that paper is evocative of the idea of inverse radial spaghettification:¹ “Radial Motion into an Einstein–Rosen Bridge.” Likewise, the title of Lewandowski’s October 2009 talk at LSU was evocative: “Spin foams from loop quantum gravity perspective.” What was this new perspective that Lewandowski was evangelizing in Louisiana just a month after arXiv rejected [31]?

While on the topic of the conduct of science in a manner that is other than ethical, consider the following. At some point in 2011 while preparing a draft of [40], this writer encountered a slideshow from another talk given at LSU. The title was something like “Path Integral Approach to Spin Foams,” and the name on the slides was likely Jonathan Engle (a speaker in [111]: the “eulogy” for LQC.) The slides were dated from the end of 2008, but when this writer checked on the seminar schedule at the host university, LSU, the talk was really given at the end of 2009. The date from 2008 does not appear to have been “a typo,” in the opinion of this writer. The

¹The term “inverse radial spaghettification” did not appear in the literature until 2012 because arXiv did not allow it to be added to the literature in 2011. To understand how the title of Poplawski’s 2010 paper is evocative of 2009’s [31], note that radial motion means 1D motion, and together with “into an Einstein–Rosen bridge,” it means motion toward a bridge between two distant regions of the universe along the 1D manifold defined by the motion. The idea presented in [31] was that dark energy is an expected feature in pairs of worldsheets in the cosmological lattice connected in 1D through a bounce. The connection is 1D because it is along χ^5 .

erroneous time stamp is notable because the path integral formulation of spin foams was not yet conceived in 2008, and a lesser error might not have changed the year of initial formulation to precede the MCM’s 2009 path integral cosmology [31]. Based on the description of a new use for the Feynman path integral in [31], and on the fact that Engle was Ashtekar’s PhD student, it is likely that the new topic presented and misdated in this talk was inspired by [31]. When one views the LSU Physics and Astronomy talk schedule archives [248], one sees all the years 2004–present, except 2009–2012: the window in which Engle presented the misdated slides. If other researchers were already jockeying in 2009 to position themselves to receive credit for a discovery that was not their own, then whose discovery was it? A full forensic accounting of the failure of physics to self-correct in this regard is required.

Finally, we wish to point out that Lewandowski is a coauthor on [249] which was published in September 2009 around the same time we were proposing to wrap the Minkowski diagram around a cylinder [31]. Therein, Kamiński et al. refer to an unusual cylindrical object $\text{Cyl}(\mathcal{A}(\Sigma))$. One sees that same object in at least one earlier arXiv preprint coauthored by Lewandowski [250], but one wonders if perhaps they have done a more professional time stamp alteration job than was suggested above when discussing Engle’s “Path Integral Formulation of Spin Foams” slides.

References

- [1] Jonathan W. Tooker. The General Relevance of the Modified Cosmological Model. *viXra:1712.0598*, (2017).
- [2] Jonathan W. Tooker. Fractional Distance: The Topology of the Real Number Line. *viXra:2111.0072*, (2019).
- [3] Jonathan W. Tooker. Tempus Edax Rerum. *viXra:1209.0010*, (2012).
- [4] Nima Arkani-Hamed, Savas Dimopoulos, and John March-Russell. Stabilization of Sub-Millimeter Dimensions: The New Guise of the Hierarchy Problem. *arXiv:hep-th/9809124*, (1998).
- [5] Nima Arkani-Hamed, Savas Dimopoulos, and Gia Dvali. The Hierarchy Problem and New Dimensions at a Millimeter. *arXiv:hep-ph/9803315*, (1998).
- [6] Jonathan W. Tooker. Quantum Structure. *viXra:1302.0037*, (2013).
- [7] Jonathan W. Tooker. Geometric Cosmology. *viXra:1301.0032*, (2013).
- [8] J. M. Overduin and P. S. Wesson. Kaluza-Klein Gravity. *arXiv:gr-qc/9805018*, (1998).
- [9] Theodor Kaluza. The Unification Problem in Physics. *Sitzungsber. Preuss. Akad. Wiss. Berlin., 966-972*, (1921).
- [10] Oskar Klein. The Atomicity of Electricity as a Quantum Theory. *Nature. 118 2971*, (1926).
- [11] F. Englert and R. Brout. Broken Symmetry and the Mass of Gauge Vector Mesons. *Phys. Rev. Lett. 13 321-323*, (1964).
- [12] Peter W. Higgs. Broken Symmetries and the Masses of Gauge Bosons. *Phys. Rev. Lett. 13 (16)*, (1964).
- [13] G.S. Guralnik, C.R. Hagen, and T.W. Kibble. Global Conservation Laws and Massless Particles. *Phys. Rev. Lett. 13 585-87*, (1964).
- [14] Tom W.B. Kibble. Englert–Brout–Higgs–Guralnik–Hagen–kibble Mechanism (History). *Scholarpedia 4 (1) 8741*, (2009).
- [15] Gerald S. Guralnik. The History of the Guralnik, Hagen and Kibble Development of the Theory of Spontaneous Symmetry Breaking and Gauge Particles. *arXiv:0907.3466*, (2009).
- [16] Axel Maas. Brout–Englert–Higgs Physics: From Foundations to Phenomenology. *arXiv:1712.04721*, (2017).
- [17] J. Beringer et al. (Particle Data Group). Higgs Bosons: Theory and Searches. *Phys. Rev. D86, 010001*, (2012).
- [18] The ATLAS Collaboration. Observation of a New Particle in the Search for the Standard Model Higgs Boson with the ATLAS Detector at the LHC. *arXiv:1207.7214*, (2012).
- [19] The CMS Collaboration. Observation of a New Boson at a Mass of 125 GeV with the CMS Experiment at the LHC. *arXiv:1207.7235*, (2012).
- [20] John P. Ralston. The Need to Fairly Confront Spin-1 for the New Higgs-like Particle. *arXiv:1211.2288*, (2012).
- [21] Nima Arkani-Hamed. The Inevitability of Physical Laws: Why the Higgs Has to Exist, (2012). www.youtube.com/watch?v=3wRCW7bspUg [1:01:35].
- [22] The ATLAS Collaboration. Evidence for the Spin-0 Nature of the Higgs Boson Using ATLAS Data. *arXiv:1307.1432*, (2013).

- [23] The ATLAS Collaboration. Study of the Spin and Parity of the Higgs Boson in Diboson Decays with the ATLAS Detector. *arXiv:1506.05669*, (2015).
- [24] The ATLAS Collaboration. Determination of Spin and Parity of the Higgs Boson in the $WW^* \rightarrow e\nu\mu\nu$ Decay Channel with the ATLAS Detector. *arXiv:1503.03643*, (2015).
- [25] The CMS Collaboration. Measurement of the Properties of a Higgs Boson in the Four-Lepton Final State. *arXiv:1312.5353*, (2013).
- [26] The CMS Collaboration. Constraints on the Spin-Parity and Anomalous HVV Couplings of the Higgs Boson in Proton Collisions at 7 and 8 TeV. *arXiv:1411.3441*, (2014).
- [27] P.A. Zyla et al. (Particle Data Group). 2020 Review of Particle Physics. *Prog. Theor. Exp. Phys. 083C01*, (2020).
- [28] John Ellis and Tevong You. Updated global analysis of higgs couplings. *arXiv:1303.3879*, (2013).
- [29] The Royal Swedish Academy of Sciences. The BEH Mechanism, Interactions with Short Range Forces and Scalar Particles, (2013). www.nobelprize.org/uploads/2018/06/advanced-physicsprize2013.pdf.
- [30] Jonathan W. Tooker. Derivation of the Fine Structure constant. *viXra:1208.0076*, (2012).
- [31] Jonathan W. Tooker. Modified Spacetime Geometry Addresses Dark Energy, Penrose's Entropy Dilemma, Baryon Asymmetry, Inflation and Matter Anisotropy. *viXra:1302.0022*, (2009).
- [32] The BaBar Collaboration. Observation of Time Reversal Violation in the B0 Meson System. *arXiv:1207.5832*, (2012).
- [33] Paul J. Steinhardt. The Inflation Debate. *Scientific American*, (2011).
- [34] S. Perlmutter et al. Measurements of omega and lambda from 42 high-redshift supernovae. *arXiv:astro-ph/9812133*, (1998).
- [35] Brian P. Schmidt et al. The High-Z Supernova Search: Measuring Cosmic Deceleration and Global Curvature of the Universe Using Type Ia Supernovae. *arXiv:astro-ph/9805200*, (1998).
- [36] Adam G. Riess et al. Observational Evidence from Supernovae for an Accelerating Universe and a Cosmological Constant. *arXiv:astro-ph/9805201*, (1998).
- [37] Jack Gillum, Menelaos Hadjicostis, and Eric Tucker. US Probe of Ex-Trump Aide Extends to Cyprus, (2017). AP News. apnews.com/article/d43ef4166da6400ab45140978854bbbb.
- [38] J. Scherk. An Overview of Supersymmetry and Supergravity, (1979). lib-extopc.kek.jp/preprints/PDF/1979/7910/7910262.pdf.
- [39] Tom Ostoma and Mike Trushyk. Cellular Automata Theory and Physics: A New Paradigm for the Unification of Physics. *arXiv:physics/9907013*, (1999).
- [40] Jonathan W. Tooker. Dark Energy in M-Theory. *viXra:1208.0077*, (2011).
- [41] R. Arnowitt, S. Deser, and C.W. Misner. Note on the Positive-definiteness of the Energy of the Gravitational Field. *Annals of Physics* **11**, **116**, (1960).
- [42] R. Arnowitt, S. Deser, and C.W. Misner. Coordinate Invariance and Energy Expressions in General Relativity. *Phys. Rev.* **122**, **3**, (1960).
- [43] E. Rubino, J. McLenaghan, S. C. Kehr, F. Belgiorno, D. Townsend, S. Rohr, C.E. Kuklewicz, U. Leonhardt, F. König, and D. Faccio. Negative Frequency Resonant Radiation. *arXiv:1201.2689*, (2012).
- [44] Deiter Gernert. How to Reject any Scientific Manuscript. *viXra:0907.0020*, (2009).

- [45] E. Rubino, A. Lotti, F. Belgiorno, S.L. Cacciatori, A. Couairon, U. Leonhardt, and D. Faccio. Soliton-induced relativistic-scattering and amplification. *arXiv:1211.0256*, (2012).
- [46] Andrea Shalal. Lockheed says makes breakthrough on fusion energy project a, (2020). news.yahoo.com/lockheed-says-makes-breakthrough-fusion-energy-project-105429233--finance.htmlh.
- [47] Jonathan W. Tooker. Zeros of the Riemann Zeta Function within the Critical Strip and off the Critical Line. *viXra:1912.0030*, (2019).
- [48] Jonathan W. Tooker. Quick Disproof of the Riemann Hypothesis. *viXra:1906.0236*, (2019).
- [49] Jonathan W. Tooker. On the Riemann Zeta Function. *viXra:1703.0073*, (2017).
- [50] Abhay Ashtekar, Miguel Campiglia, and Adam Henderson. Loop Quantum Cosmology and Spin Foams. *arXiv:0909.4221*, (2009).
- [51] Jonathan W. Tooker. The General Relevance of the Modified Cosmological Model, Section III.3. *viXra:1712.0598*, (2017).
- [52] Frank Wilczek. Quantum Time Crystals. *arXiv:1202.2539*, (2012).
- [53] Patrick Bruno. Comment on “Quantum Time Crystals”: A New Paradigm or Just Another Proposal of Perpetuum Mobile? *arXiv:1210.4128*, (2012).
- [54] Martin Hairer. A Theory of Regularity Structures. *arXiv:1303.5113*, (2013).
- [55] Ian Sample. UK Mathematician Wins Richest Prize in Academia, (2020). www.theguardian.com/science/2020/sep/10/uk-mathematician-martin-hairer-wins-richest-prize-in-academia-breakthrough.
- [56] Stephon Alexander, William J. Cunningham, Jaron Lanier, Lee Smolin, Stefan Stanojevic, Michael W. Toomey, and Dave Wecker. The Autodidactic Universe. *arXiv:2104.03902*, (2021).
- [57] Arvind Borde, Alan H. Guth, and Alexander Vilenkin. Inflationary Spacetimes are not Past-complete. *arXiv:gr-qc/0110012*, (2001).
- [58] Abhay Ashtekar and Parampreet Singh. Loop Quantum Cosmology: A Status Report. *arXiv:1108.0893*, (2011).
- [59] Juan M. Maldacena. The Large N Limit of Superconformal Field Theories and Supergravity. *arXiv:hep-th/9711200*, (1997).
- [60] R. de la Madrid. The Role of the Rigged Hilbert Space in Quantum Mechanics. *arXiv:quant-ph/0502053*, (2005).
- [61] R. de la Madrid. The Rigged Hilbert Space of the Algebra of the One-Dimensional Rectangular Barrier Potential. *arXiv:quant-ph/0407195*, (2004).
- [62] R. de la Madrid. Quantum Mechanics in Rigged Hilbert Space Language, (2001). PhD Thesis, Universidad de Valladolid, galaxy.cs.lamar.edu/~rafaelm/webdis.pdf.
- [63] Leslie E. Ballentine. *Quantum Mechanics: A Modern Development*. World Scientific, (1998).
- [64] E. Sather. The mystery of the Matter Asymmetry. *SLAC Beam Line*, (1996).
- [65] Helmut Hasse. Muonic Hydrogen and the Proton Radius Puzzle. *arXiv:1301.0905*, (2013).
- [66] Yoon-Ho Kim, R. Yu, S.P. Kulik, Y.H. Shih, and Marlan .O. Scully. A Delayed Choice Quantum Eraser. *arXiv:quant-ph/9903047*, (1999).
- [67] James Overduin. Why Do We Need a Single Theory of Physics?, (2011). www.youtube.com/watch?v=-w6fZiuBSBw.

- [68] R. P. Feynman. Space-Time Approach to Non-Relativistic Quantum Mechanics. *Rev. Mod. Phys.* **20** 367, (1948).
- [69] Chris J. Isham. *Lectures on Quantum Theory: Mathematical and Structural Foundations*. Imperial College Press, (1995).
- [70] David Ritz Finkelstein. General Quantization. *arXiv:quant-ph/0601002*, (2005).
- [71] Jonathan W. Tooker. Ontological Physics. *viXra:1312.0168*, (2013).
- [72] Jonathan W. Tooker. The Golden Ratio in the Modified Cosmological Model. *viXra:1807.0136*, (2018).
- [73] H. Bondi and T. Gold. The Steady-State Theory of the Expanding Universe. *Mon. Not. Roy. Ast. Soc.* **108** 252-270, (2012).
- [74] F. Hoyle. A New Model for the Expanding Universe. *Mon. Not. Roy. Ast. Soc.* **108** 372-382, (1948).
- [75] Paul Roman. *Advanced Quantum Theory*. Addison Wesley, (1965).
- [76] A. Zee. *Quantum Field Theory in a Nutshell, 2nd Ed.* Princeton, (2010).
- [77] H. Dieter Zeh. On the Interpretation of Measurement in Quantum Theory. *Foundations of Physics.* **1** 69-76, (1970).
- [78] James F. Woodward. Killing Time. *Foundations of Physics Letters.* **9** 1-23, (1996).
- [79] Jonathan W. Tooker. Real Numbers in the Neighborhood of Infinity. *viXra:1811.0222*, (2018).
- [80] E. Schrödinger. Quantisierung als Eigenwertproblem. *Annalen Phys.* **384** 361, (1926).
- [81] E. Schrödinger. An undulatory theory of the mechanics of atoms and molecules. *Phys. Rev.* **28** (6) 1049-1070, (1926).
- [82] Rubin H. Landau. *Quantum Mechanics II: A Second Course in Quantum Theory 2nd Edition*. Wiley-VCH, (1995).
- [83] David J. Griffiths. *Introduction to Quantum Mechanics, 2nd Ed.* Pearson Prentice Hall, (1995).
- [84] J.J. Sakurai and Jim Napolitano. *Modern Quantum Mechanics, 3rd ed.* Cambridge University Press, (2021).
- [85] Jonathan W. Tooker. Time Arrow Spinors for the Modified Cosmological Model. *viXra:1807.0454*, (2018).
- [86] David Ellerman. A Very Common Fallacy in Quantum Mechanics: Superposition, Delayed Choice, Quantum Erasers, Retrocausality, and All That. *arXiv:1112.4522*, (2011).
- [87] Richard P. Feynman. *QED: The Strange Theory of Light and Matter*. Princeton University Press, (1985).
- [88] The L3 Collaboration. Measurement of the Running of the Fine-Structure Constant. *arXiv:hep-ex/0002035*, (2000).
- [89] U. Amaldi, W. de Boer, and H. Fürstenau. Comparison of Grand Unified Theories with Electroweak and Strong Coupling Constants Measured at LEP. *Phys. Lett. B.* **260** 447-455, (1991).
- [90] G. Venanzoni. Seminar at CERN, (2017). indico.cern.ch/event/586436/attachments/1420240/2206017/gv.CERN280317.pdf.
- [91] The KLOE-2 Collaboration. Measurement of the Running of the Fine Structure Constant Below 1 GeV with the KLOE Detector. *arXiv:1609.06631*, (2016).

- [92] The OPAL Collaboration. Measurement of the Running of the QED Coupling in Small-Angle Bhabha Scattering at LEP. *arXiv:hep-ex/0505072*, (2005).
- [93] NIST. Current Advances: The Fine-Structure Constant and Quantum Hall Effect. physics.nist.gov/cuu/Constants/alpha.html.
- [94] H. Fritzsche. Fundamental Constants at High Energy. *arXiv:hep-ph/0201198*, (2002).
- [95] Jonathan W. Tooker. Kerr-Newman, Jung, and the Modified Cosmological Model. *viXra:1405.0329*, (2014).
- [96] Jonathan W. Tooker. Quantum Gravity. *viXra:1506.0055*, (2015).
- [97] Jonathan W. Tooker. Infinitudinal Complexification. *viXra:1608.0234*, (2016).
- [98] E.R. Laithwaite. The Multiplication of Bananas by Umbrellas. *Electrical Review*. 20/27 822-824, (1974).
- [99] E.R. Laithwaite. Professor Eric Laithwaite Gives a Demonstration of a Large Gyro Wheel, (1983). www.youtube.com/watch?v=JRPC7a_AcQo.
- [100] Richard P. Feynman, Robert B. Leighton, and Matthew Sands. *The Feynman Lectures on Physics*. Addison–Wesley, (1964).
- [101] Andrew Wiles. The Birch and Swinnerton–Dyer Conjecture, (2006). Clay Mathematics Institute, www.claymath.org/sites/default/files/birchswin.pdf.
- [102] Brent Johnson. An Introduction to the Birch and Swinnerton-Dyer Conjecture. *Rose–Hulman Undergraduate Mathematics Journal* **16** (1) 15, (2015).
- [103] Predrag Cvitanović. *Universality in Chaos*. CRC Press, (1989).
- [104] Reginald D. Smith. Period Doubling, Information Entropy, and Estimates for Feigenbaum’s Constants. *arXiv:1307.5251*, (2013).
- [105] M.J. Feigenbaum. Universality in Complex Discrete Dynamics, (1977). Los Alamos National Laboratory, Report No. LA-6816-PR.
- [106] M.J. Feigenbaum. Quantitative Universality for a Class of Nonlinear Transformations. *J. Stat. Phys.* **19** 25-52, (1978).
- [107] Kirk McDonald. Can magnetic field lines break and reconnect?, (2015). www.physics.princeton.edu/~kirkmcd/examples/reconnect.pdf.
- [108] David Walker. The de Sitter Space-Time and the Riemannian Space \mathbb{H}^4 : Two Four-Dimensional Surfaces of Hyperboloids Embedded within the Five-Dimensional Minkowski Space-Time, (2015). www.sternwarte-luebeck.de/download/forschung/Hyperbolic_space.pdf.
- [109] L.F. Secco et al. Dark Energy Survey Year 3 Results: Three-Point Shear Correlations and Mass Aperture Moments. *arXiv:2201.05227*, (2022).
- [110] Jonathan W. Tooker. The General Relevance of the Modified Cosmological Model, Section III.9. *viXra:1712.0598*, (2017).
- [111] Martin Bojowald. Loop Quantum Cosmology: A Eulogy, (2013). www.perimeterinstitute.ca/videos/quantum-cosmology-1, Inactive on May 24, 2022.
- [112] Jonathan W. Tooker. The General Relevance of the Modified Cosmological Model, Section III.2. *viXra:1712.0598*, (2017).
- [113] Y. Mino, M. Sasaki, and T. Tanaka. Gravitational Radiation Reaction to a Particle Motion. *Phys. Rev. D*. **55** 3457, (1997).

- [114] Theodore C. Quinn and Robert M. Wald. An Axiomatic Approach to Electromagnetic and Gravitational Radiation Reaction of Particles in Curved Spacetime. *Phys. Rev. D.* **56** 3381, (1997).
- [115] Math Pages. Retarded and Advanced Potential. www.mathpages.com/home/kmath567/kmath567.htm.
- [116] H. Dieter Zeh. *The Physical Basis of the Direction of Time, 4th Ed.* Springer-Verlag, (2001).
- [117] L. L. Williams. Field Equations and Lagrangian for the Kaluza Metric Evaluated with Tensor Algebra Software. *Journal of Gravity*, (2015).
- [118] David Bailin and Alex Love. Kaluza-Klein Theories. *Reports on Progress in Physics*, (1987).
- [119] Robert B. Mann. Gravity and Differential Geometry. In *An Introduction to Kaluza-Klein Theories*. World Scientific, 1984.
- [120] Sanjeev S. Seahra and Paul S. Wesson. Application of the Campbell–Magaard Theorem to Higher-Dimensional Physics. *arXiv:gr-qc/0302015*, (2003).
- [121] Paul S. Wesson. The Embedding of General Relativity in Five-Dimensional Canonical Space: A Short History and a Review of Recent Physical Progress. *arXiv:1011.0214*, (2010).
- [122] Nick Cook. *The Hunt for Zero Point: Inside the Classified World of Antigravity Technology*. Crown, (2003).
- [123] David S. Alexander. Advanced Energetics for Aeronautical Applications: Volume II, (2005). ntrs.nasa.gov/api/citations/20050170447/downloads/20050170447.pdf.
- [124] J. Mendonça. *Theory of Photon Acceleration*. CRC Press, 01 2001.
- [125] C. Patrignani et al. (Particle Data Group). 2016 Review of Particle Physics. *Chin. Phys. C.* **40** 100001, (2016).
- [126] M. Tanabashi et al. (Particle Data Group). 2018 Review of Particle Physics. *Phys. Rev. D.* **98** 030001, (2018).
- [127] J.A. Wheeler and R.P. Feynman. Interaction with the Absorber as the Mechanism of Radiation. *Rev. Mod. Phys.* **17** 157-181, (1945).
- [128] J.A. Wheeler and R.P. Feynman. Classical Electrodynamics in Terms of Direct Interparticle Action. *Rev. Mod. Phys.* **21** (3) 425-433, (1949).
- [129] Richard P. Feynman. The Principle of Least Action in Quantum Mechanics, (1942). PhD Thesis, Princeton University.
- [130] Helge Kragh. *Dirac: A Scientific Biography*. Cambridge University Press, (1990).
- [131] F. G. Friedlander. *The Wave Equation on a Curved Space-Time*. Cambridge University Press, (1976).
- [132] Paul S. Wesson and James M. Overduin. Wave Mechanics and the Fifth Dimension. *arXiv:1302.1190*, (2013).
- [133] B.L. Ioffe. Axial Anomaly: The Modern Status. *arXiv:hep-ph/0611026*, (2006).
- [134] Jean-Francois Burnol. The Explicit Formula and a Propagator. *arXiv:math/9809119v2*, (1998).
- [135] J. Borwein, D. Bradley, and R. Crandall. Computational Strategies for the Riemann Zeta Function. *J. Comp. App. Math.* **121**, (2000).
- [136] Alain Connes. Trace Formula in Noncommutative Geometry and the Zeros of the Riemann Zeta Function. *Selecta Mathematica.* **5** 29–106, (2003).
- [137] Predrag Cvitanović, Roberto Artuso, Ronnie Mainieri, Gregor Tanner, Gábor Vattay, Niall Whelan, and Andreas Wirzba. *Chaos: Classical and Quantum*. chaosbook.org, (*In preparation*).

- [138] M.V. Berry and J.P. Keating. The Riemann Zeros and Eigenvalue Asymptotics. *SIAM Review* **41**, 2, 236–266, (1999).
- [139] Julian Brown. Where Two Worlds Meet. *New Scientist*, May 18, Issue 2030, (1996).
- [140] Kirti Joshi. On Mochizuki’s Idea of Anabelomorphy and its Applications. *arXiv:2003.01890*, (2020).
- [141] Shinichi Mochizuki. Inter-Universal Teichmüller Theory I: Construction of Hodge Theaters. *PRIMS*. **57** 3-207, (2021).
- [142] Shinichi Mochizuki. Inter-Universal Teichmüller Theory II: Hodge—Arakelo—Theoretic Evaluation. *PRIMS*. **57** 209-401, (2021).
- [143] Shinichi Mochizuki. Inter-Universal Teichmüller Theory III: Canonical Splittings of the Log-Theta-Lattice. *PRIMS*. **57** 403-626, (2021).
- [144] Shinichi Mochizuki. Inter-Universal Teichmüller Theory IV: Log-Volume Computations and Set-Theoretic Foundations. *PRIMS*. **57** 627-723, (2021).
- [145] Peter Scholze and Jakob Styx. Why abc is Still a Conjecture, (2018). ncatlab.org/nlab/files/why-abc-is-still-a-conjecture.pdf.
- [146] Shinichi Mochizuki. Report on Discussions, Held During the Period March 15-20, Concerning inter-Universal Teichmüller Theory (IUTCH), (2019). www.kurims.kyoto-u.ac.jp/~motizuki/Rpt2018.pdf.
- [147] David Ritz Finkelstein. Recursive Quantum Gauge Theory. *arXiv:1007.1923*, (2010).
- [148] David Ritz Finkelstein. Simplicial Quantum Dynamics. *arXiv:1108.1495*, (2011).
- [149] David Ritz Finkelstein. On “Law Without Law”. *arXiv:1201.1596*, (2012).
- [150] David Ritz Finkelstein. Palev Statistics and the Chronon. *arXiv:1201.1597*, (2012).
- [151] David Ritz Finkelstein. Nature as Quantum Computer. *arXiv:1201.1599*, (2012).
- [152] David Ritz Finkelstein. Quantum Set Algebra for Quantum Set Theory. *arXiv:1403.3725*, (2014).
- [153] David Ritz Finkelstein. Quantum Field Theory in Quantum Set Algebra. *arXiv:1403.3726*, (2014).
- [154] Kate Land and Joao Magueijo. The Axis of Evil. *arXiv:astro-ph/0502237*, (2005).
- [155] Roger Penrose. Gravitational Collapse and Space-Time Singularities. *Phys. Rev. Lett.* **14** (3) 57-59, (1965).
- [156] Adolf Hitler. *Mein Kampf (English Translation)*. Harper, (1998).
- [157] Charles L. Fefferman. Existence and Smoothness of the Navier–Stokes Equation, (2000). Clay Mathematics Institute, www.claymath.org/sites/default/files/navierstokes.pdf.
- [158] Arthur Jaffe and Edward Witten. Quantum Yang–Mills Theory, (2000). Clay Mathematics Institute, www.claymath.org/sites/default/files/yangmills.pdf.
- [159] Michael R. Douglas. Report on the Status of the Yang–Mills Millenium Prize Problem, (2004). Clay Mathematics Institute, www.claymath.org/sites/default/files/ym2.pdf.
- [160] Stefan Banach and Alfred Tarski. Sur la décomposition des ensembles de points en parties respectivement congruentes. *Fundamenta Mathematicae*. **6** 244–277, (1924).
- [161] Jonathan W. Tooker. Infinitely Complex Topology Changes with Quaternions and Torsion. *viXra:1505.0131*, (2015).
- [162] Jonathan W. Tooker. Proof of the Limits of Sine and Cosine at Infinity. *viXra:1809.0234*, (2018).

- [163] John H. Conway. *On Numbers and Games*. CRC Press, (2000).
- [164] Abraham Robinson. *Non-standard Analysis, Revised Ed.* Princeton University Press, (1996).
- [165] Jonathan W. Tooker. The General Relevance of the Modified Cosmological Model, Section I.1. *viXra:1712.0598*, (2017).
- [166] Lisa Randall and Raman Sundrum. A Large Mass Hierarchy from a Small Extra Dimension. *arXiv:hep-ph/9905221*, (1999).
- [167] Lisa Randall and Raman Sundrum. An Alternative to Compactification. *arXiv:hep-th/9906064*, (1999).
- [168] Wikipedia. Randall–Sundrum Model. en.wikipedia.org/wiki/Randall-Sundrum_model.
- [169] Merab Gogberashvili. Hierarchy Problem in the Shell Universe Model. *arXiv:hep-ph/9812296*, (1998).
- [170] Merab Gogberashvili. Our World as an Expanding Shell. *arXiv:hep-ph/9812365*, (1998).
- [171] Merab Gogberashvili. Four Dimensionality in Non-Compact Kaluza–Klein Model. *arXiv:hep-ph/9904383*, (1999).
- [172] nLab. Randall–Sundrum model. ncatlab.org/nlab/show/Randall-Sundrum+model.
- [173] C. Brans and R.H. Dicke. Mach’s Principle and a Relativistic Theory of Gravitation. *Phys. Rev.* **124** (3) 925-935, (1961).
- [174] Georgios Kofinas. The Complete Brans–Dicke Theories. *arXiv:1510.06845*, (2015).
- [175] Carl H. Brans. The Roots of Scalar-Tensor Theory: An Approximate History. *arXiv:gr-qc/0506063*, (2005).
- [176] Jianbo Lu, Yabo Wu, Weiqiang Yang, Molin Liu, and Xin Zhao. The Generalized Brans–Dicke Theory and its Cosmology. *arXiv:1803.00365*, (2018).
- [177] Lawrence M. Krauss. The Energy of Empty Space that Isn’t Zero, (2006). www.edge.org/conversation/the-energy-of-empty-space-that-isn-39t-zero.
- [178] C. Bennett et al. First Year Wilkinson Microwave Anisotropy Probe (WMAP) Observations: Foreground Emission. *arXiv:astro-ph/0302208*, (2003).
- [179] The Planck Collaboration. Planck 2013 Results. XXIII. Isotropy and Statistics of the CMB. *arXiv:1303.5083*, (2013).
- [180] P. Ehrenfest. Gleichförmige Rotation starrer Körper und Relativitätstheorie. *Physik Zeitschrift.* **10** 918, (1909).
- [181] Oyvind Grøn. Space Geometry in Rotating Reference Frames: A Historical Appraisal, (2004).
- [182] Slava G. Turyshev and Viktor T. Toth. The Pioneer Anomaly. *arXiv:1001.3686*, (2010).
- [183] Dario Modenini and Paolo Tortora. Pioneer 10 and 11 Orbit Determination Analysis Shows no Discrepancy with Newton–Einstein’s Laws of Gravity. *arXiv:1311.4978*, (2013).
- [184] Scott Locklin. The Enigma of the Ford Paradox, (2013). scottlocklin.wordpress.com/2013/03/07/the-enigma-of-the-ford-paradox/.
- [185] Joseph Ford, Georgio Mantica, and Gerald H. Ristow. The Arnol’d Cat: Failure of the Correspondence Principle. *Physica D*, **50**:493–520, (1991).
- [186] Joseph Ford and Matthias Ilg. Eigenfunctions, Eigenvalues, and Time Evolution of Finite, Bounded, Undriven, Quantum Systems are Not Chaotic. *Phys. Rev. A.* **45** (9) 6165-6173, (1992).

- [187] Donatello Dolce. Compact Time and Determinism for Bosons: Foundations. *arXiv:0903.3680*, (2009).
- [188] Donatello Dolce. Gauge Interaction as Periodicity Modulation. *arXiv:1110.0315*, (2011).
- [189] Donatello Dolce. Classical Geometry to Quantum Behavior Correspondence in a Virtual Extra Dimension. *arXiv:1110.0316*, (2011).
- [190] Donatello Dolce. Intrinsic Periodicity: The Forgotten Lesson of Quantum Mechanics. *arXiv:1304.4167*, (2013).
- [191] L. de Broglie. Recherches sur la théorie des Quanta. *Ann. de Physique*. **10** (3) 22-128, (1925).
- [192] Gerard 't Hooft. Time, the Arrow of Time, and Quantum Mechanics. *Front. Phys.* **6** (81), (2018).
- [193] Jonathan W. Tooker. On Bell's Inequality. *viXra:1312.0173*, (2013).
- [194] Charles W. Misner, Kip S. Thorne, and John Archibald Wheeler. *Gravitation*. Freeman, (1970).
- [195] Sean M. Carroll. *Spacetime and Geometry: An Introduction to General Relativity*. Pearson, (2004).
- [196] Lev Davidovich Landau. The Moment of a 2-Photon System. *Dokl. Akad. Nauk SSSR*. **60** 207-209, (2016).
- [197] Chen Ning Yang. Selection Rules for the Dematerialization of a Particle into Two Photons. *Phys. Rev.* **77** (2) 242-245, (2016).
- [198] Laura Ferrarese. Beyond the Bulge: a Fundamental Relation Between Supermassive Black Holes and Dark Matter Halos. *arXiv:astro-ph/0203469*, (2002).
- [199] Maarten Baes, Pieter Buyle, George K. T. Hau, and Herwig Dejonghe. Observational Evidence for a Connection Between Supermassive Black Holes and Dark Matter Haloes. *arXiv:astro-ph/0303628v2*, (2003).
- [200] Y. Fukuda et al. (Super-Kamiokande Collaboration). Evidence for Oscillation of Atmospheric Neutrinos. *Phys. Rev. Lett.* **81** 1562, (1998).
- [201] Q.R. Ahmad et al. (SNO Collaboration). Measurement of the Rate of $\nu_e + d \rightarrow p + p + e^-$ Interactions Produced by B Solar Neutrinos at the Sudbury Neutrino Observatory. *Phys. Rev. Lett.* **87** 071301, (2001).
- [202] Q.R. Ahmad et al. (SNO Collaboration). Direct Evidence for Neutrino Flavor Transformation from Neutral-Current Interactions in the Sudbury Neutrino Observatory. *Phys. Rev. Lett.* **89** 011301, (2002).
- [203] Nima Arkani-Hamed and Jaroslav Trnka. The Amplituhedron. *arXiv:1312.2007*, (2013).
- [204] Alfred Shapere and Frank Wilczek. Classical Time Crystals. *arXiv:1202.2537*, (2012).
- [205] Dominic V. Else, Bela Bauer, and Chetan Nayak. Floquet Time Crystals. *arXiv:1603.08001*, (2016).
- [206] Rodrigo Ledesma-Aguilar. Time Crystals: How Scientists Discovered a New State of Matter, (2017). Newsweek. www.newsweek.com/time-crystals-quantum-computing-scientific-breakthrough-559522.
- [207] Jonathan W. Tooker. The Truth about Geometric Unity. *viXra:1307.0075*, (2013).
- [208] Tongcang Li, Zhe-Xuan Gong, Zhang-Qi Yin, H. T. Quan, Xiaobo Yin, Peng Zhang, L.-M. Duan, and Xiang Zhangk. Space-Time Crystals of Trapped Ions. *arXiv:1206.4772*, (2012).
- [209] Krzysztof Sacha. Modeling Spontaneous Breaking of Time-Translation Symmetry. *arXiv:1410.3638*, (2014).

- [210] Vedika Khemani, Achilleas Lazarides, Roderich Moessner, and S. L. Sondhi. On the Phase Structure of Driven Quantum Systems. *arXiv:1508.03344*, (2015).
- [211] Gerard 't Hooft. The Cellular Automaton Interpretation of Quantum Qechanics. *arXiv:1405.1548*, (2014).
- [212] Gerard 't Hooft. Determinism Beneath Quantum Mechanics. *arXiv:quant-ph/0212095*, (2002).
- [213] Gerard 't Hooft. The Mathematical Basis for Deterministic Quantum Mechanics. *arXiv:quant-ph/0604008*, (2006).
- [214] Paul C. W. Davies. Thermodynamic Phase Transitions of Kerr–Newman Black Holes in de Sitter Space. *Class. Quant. Grav.* **6**, (1989).
- [215] Paul C. W. Davies. The Thermodynamic Theory of Black Holes. *Proc. Roy. Soc. Lond. A.* **353** 499-521, (1977).
- [216] Norman Cruz, Marco Olivares, and J. R. Villanueva. The Golden Ratio in Schwarzschild–Kottler Black Holes. *arXiv:1701.03166*, (2017).
- [217] J.A. Nieto. A Link Between Black Holes and the Golden Ratio. *arXiv:1106.1600*, (2011).
- [218] Zbigniew Osiak. Black Hole Universe and Golden Ratio. *viXra:1804.0295*, (2018).
- [219] Lan Xu and Ting Zhong. Golden Ratio in Quantum Mechanics. *Nonlinear Science Letters B.* **24**, (2011).
- [220] M.S. El Naschie. A Review of E-Infinity Theory and the Mass Spectrum of High Energy Particle Physics. *Chaos, Solitons, and Fractals.* **19** 209-236, (2004).
- [221] M.S. El Naschie. The Theory of Cantorian Spacetime and High Energy Particle Physics (An Informal Review). *Chaos, Solitons, and Fractals.* **41** 2635-2646, (2009).
- [222] I. Bars, C. Deliduman, and O. Andreev. Gauged Duality, Conformal Symmetry, and Spacetime with Two Times. *arXiv:hep-th/9803188*, (1998).
- [223] Itzhak Bars. 2T-Physics 2001. *arXiv:hep-th/0106021*, (2001).
- [224] Itzhak Bars. Twistors and 2T-Physics. *arXiv:hep-th/0502065*, (2005).
- [225] Itzhak Bars. The Standard Model as a 2T-Physics Theory. *arXiv:hep-th/0610187*, (2006).
- [226] Itzhak Bars and Shih-Hung Chen. Geometry and Symmetry Structures in 2T Gravity. *arXiv:0811.2510*, (2008).
- [227] M. Creutz and B. Freedman. A Statistical Approach to Quantum Mechanics. *Annals of Physics.* **132** (2) 427-462, (1980).
- [228] Barton Zwiebach. *A First Course in String Theory, 2nd Edition*. Cambridge University Press, (2009).
- [229] Ashoke Sen. Tachyon Condensation on the Brane Antibrane System. *arXiv:hep-th/9805170*, (1998).
- [230] D. R. Lorimer, M. Bailes, M. A. McLaughlin, D. J. Narkevic, and F. Crawford. A Bright Millisecond Radio Burst of Extragalactic Origin. *arXiv:0709.4301*, (2007).
- [231] E. Petroff, J. W. T. Hessels, and D. R. Lorimer. Fast Radio Bursts. *arXiv:1904.07947*, (2019).
- [232] P. A. M. Dirac. The Physical Interpretation of the Quantum Dynamics. *Proc. R. Soc. Lond. A.* **112** 661-677, (1926).
- [233] P. A. M. Dirac. The Fundamental Equations of Quantum Mechanics. *Proc. R. Soc. Lond. A.* **109** 642-653, (1925).

- [234] W. Heisenberg. Über quantentheoretische Umdeutung kinematischer und mechanischer Beziehungen. *Zeits. f. Phys.* **33** 879-893, (1925).
- [235] Robert G. Littlejohn. Lecture Notes, (2020). <http://bohr.physics.berkeley.edu/classes/221/1112/notes/spatialdof.pdf>.
- [236] Ker Than. Every Black Hole Contains Another Universe?, (2010). National Geographic Daily News. www.nationalgeographic.com/science/article/100409-black-holes-alternate-universe-multiverse-einstein-wormholes.
- [237] Phil Berardelli. Does Our Universe Live Inside a Wormhole?, (2010). Science. www.science.org/content/article/does-our-universe-live-inside-wormhole.
- [238] Charles Q. Choi. Our Universe Was Born in a Black Hole, Theory Says, (2010). Space. www.space.com/8293-universe-born-black-hole-theory.html.
- [239] Anil Ananthaswamy. Every Black Hole May Hold a Hidden Universe, (2010). New Scientist. www.newscientist.com/article/mg20727703-000-every-black-hole-may-hold-a-hidden-universe/.
- [240] Amy Willis. A Universe Could Exist 'Inside Every Black Hole,' Claims Scientist, (2010). The Telegraph. www.telegraph.co.uk/news/science/space/7918978/A-universe-could-exist-inside-every-black-hole-claims-scientist.html.
- [241] Nikodem Poplawski. Every Black Hole Contains a New Universe, (2012). Inside Science. www.insidescience.org/news/every-black-hole-contains-new-universe.
- [242] Michael Finkel. Are We Living in a Black Hole?, (2014). National Geographic Daily News. www.nationalgeographic.com/science/article/140218-black-hole-blast-explains-big-bang.
- [243] Ellie Zolfagharifard. Are We Living Inside a Black Hole?, (2014). Daily Mail. www.dailymail.co.uk/sciencetech/article-2562921/Are-living-inside-BLACK-HOLE-Theory-suggests-elusive-regions-contain-advanced-civilisations-like-own.html.
- [244] Nikodem Poplawski. Every Black Hole Contains a New Universe, (2015). The Philadelphia Inquirer. www.inquirer.com/philly/health/science/Every_black_hole_contains_a_new_universe.html.
- [245] T. van der Sar. Decoherence-Protected Quantum Gates For a Hybrid Solid-State Spin Register. *arXiv:1202.4379*, (2012).
- [246] Charles Chapman Pugh. *Real Mathematical Analysis*. Springer, (2003).
- [247] Nikodem Poplawski. Radial Motion into an Einstein–Rosen Bridge. *arXiv:0902.1994*, (2009).
- [248] LSU Physics and Astronomy colloquium archives. www.lsu.edu/physics/colloquia-seminars/colloquia-seminars-archives.php.
- [249] Wojciech Kamiński, Marcin Kisielowski, and Jerzy Lewandowski. Spin-Foams for All Loop Quantum Gravity. *arXiv:0909.0939*, (2009).
- [250] Jerzy Lewandowski and Andrzej Okolow. Quantum Group Connections. *arXiv:0810.2992*, (2008).